

ELECTRONICS & DEFENSE

GSG-8 Gen2

SOFTWARE-DEFINED GNSS SIMULATOR



skydel



User Manual

Revision: v26.3

Date: 29 Mar 2026



SAFRAN

© 2026 Safran. All rights reserved.

Information furnished by Safran is believed to be accurate and reliable. However, no responsibility is assumed by Safran for its use, nor for any infringements of patents or other rights of third parties that may result from its use. Safran reserves the right to make changes without further notice to any products herein. Safran makes no warranty, representation or guarantee regarding the suitability of its products for any particular purpose, nor does Safran assume any liability arising out of the application or use of any product or circuit, and specifically disclaims any and all liability, including without limitation consequential or incidental damages. No license is granted by implication or otherwise under any patent or patent rights of Safran. Trademarks and registered trademarks are the property of their respective owners. Safran products are not intended for any application in which the failure of the Safran product could create a situation where personal injury or death may occur. Should Buyer purchase or use Safran products for any such unintended or unauthorized application, Buyer shall indemnify and hold Safran and its officers, employees, subsidiaries, affiliates, and distributors harmless against all claims, costs, damages, and expenses, and reasonable legal fees arising out of, directly or indirectly, any claim of personal injury or death associated with such unintended or unauthorized use, even if such claim alleges that Safran was negligent regarding the design or manufacture of the part.

Safran Electronics & Defense

safran-navigation-timing.com

Safran Trusted 4D Canada Inc.

- 1501 McGill College, Suite 760, Montreal, Quebec H3A 3M8 Canada
- 45 Becker Road, Suite A, West Henrietta, NY 14586 USA
- 3, Avenue du Canada, 91974 Les Ulis, France

Do you have questions or comments regarding this User Manual?

→ E-mail: simulationsupport@nav-timing.safrangroup.com

Blank page.

CONTENTS

CHAPTER 1

Introduction	1
1.1 What is Skydel?	2
1.2 Help	2
1.2.1 About This Manual	2
1.2.1.1 GSG-8 Gen2 Resource	2
1.2.2 Additional Resources	2
1.3 Acronyms	3
1.4 Basic GNSS Simulation Concepts	4
1.4.1 Power Levels: Live Sky vs. Simulation	5
1.4.2 Data Flow (IQ Data)	6
1.4.3 Additional Resources	6

CHAPTER 2

GSG-8 Gen2 DESCRIPTION	9
2.1 GSG-8 Gen2 Specifications	10
2.1.1 Hardware Parts	10
2.1.2 CDM-7 Information	10
2.1.3 Software	11
2.1.4 GNSS Inputs + Outputs	11
2.2 Safety Notes	11

CHAPTER 3

Using Skydel	15
3.1 Launching	16
3.1.1 Splash Screen	16
3.1.2 Welcome Screen	16
3.2 Interface	17
3.3 Main Window Subtabs	19
3.3.1 Constellations	19

3.3.2	Deviation	19
3.3.3	Spectrums	20
3.3.4	Performance	20
3.3.5	HIL	25
3.3.6	Status Log	26
3.3.7	Simulator State	26
3.3.8	Command Line Options	27
3.4	Licensing	29
3.4.0.1	License Feature List	29
3.4.0.2	License Update	31
3.5	Preferences	32
3.5.1	General	33
3.5.2	Proxy	35
3.5.3	Synchronization	36
3.5.3.1	PPS OUT Delay	37
3.5.3.2	PPS IN Delay	37
3.5.3.3	Client / Server Settings	38
3.5.3.4	GPS Timing Receiver	38
3.5.3.5	NTP Server	39
3.5.4	USRP	40
3.5.5	Dektec	42
3.5.6	Performance	44
3.5.7	CDM-7	45
3.5.7.1	Changing the CDM-7 clock mode	46
3.5.8	Custom Constellation	47
3.6	Configurations	48
3.6.1	Create New Configuration	49
3.6.2	Save Configuration	49
3.6.3	Open Configuration	49
3.6.4	Set as Default Configuration	50
3.6.5	Reset Default Configuration	50
3.7	Running Your First Simulation	50
3.7.1	Create a New Configuration	51
3.7.2	Add a radio	51
3.7.3	Select GNSS Signals	52
3.7.4	Select Vehicle Motion	53

3.7.5 Start the Simulation	54
3.7.6 Additional Skydel Resources	57
3.8 Settings: Overview	57
3.9 Settings: Output	63
3.9.1 Radio Selection	64
3.9.2 Signal Selection	65
3.9.3 Reference Power Level	69
3.9.4 Optimizing Performance	70
3.9.5 IQ Data Files	72
3.10 Settings: Start Time	73
3.10.0.1 Custom Time	75
3.10.0.2 Current Computer Time	76
3.10.0.3 NTP Server Time	76
3.10.0.4 GPS Timing Receiver Time	77
3.10.0.5 Leap Seconds	77
3.10.0.6 Duration	78
3.11 Settings: Global	79
3.11.0.1 Atmosphere	79
3.11.0.2 Earth Orientation	82
3.11.0.3 Propagation Model	83
3.11.0.4 Logging	85
3.11.0.5 Signal Power	97
3.11.0.6 Synchronize Simulators	100
3.11.0.7 Synchronize configuration between Main and Workers	100
3.11.0.8 Synchronize Simulators with a GPS Timing receiver	101
3.11.0.9 Satellite Data Update	102
3.11.0.10 Terrain Obscuration (Plugin)	105
3.12 Settings: Constellations	105
3.12.1 GPS	106
3.12.1.1 General	106
3.12.1.2 Data Sets	108
3.12.1.3 Message Modification	111
3.12.1.4 Message Sequence	120
3.12.1.5 Orbits	121
3.12.1.6 Perturbations	124
3.12.1.7 Clock & Group Delay	125
3.12.1.8 Health	126

3.12.1.9	Multipath	126
3.12.1.10	Signal Enable/Disable	130
3.12.1.11	Transmitted PRN	133
3.12.1.12	Filter Assignment	134
3.12.1.13	Errors	136
3.12.1.14	Antenna	138
3.12.2	GLONASS	143
3.12.2.1	General	143
3.12.2.2	Leap Seconds	145
3.12.3	GALILEO	145
3.12.3.1	F/NAV Source Diversity	145
3.12.3.2	OSNMA	146
3.12.3.3	Inter-Modulation	149
3.12.4	BEIDOU	149
3.12.5	QZSS	150
3.12.5.1	L1S augmentations	150
3.12.5.2	QZSS L6	152
3.12.6	NavIC	152
3.12.7	SBAS	153
3.12.7.1	General	153
3.12.7.2	Manual Message Sequence	153
3.12.7.3	Health	154
3.12.7.4	Service Providers Assignment	155
3.12.7.5	Automatic Message Sequence	156
3.12.7.6	Ionospheric Masks	158
3.12.7.7	Ionospheric GIVEI	159
3.12.7.8	Service Message	161
3.12.7.9	Degradation Parameters	161
3.12.7.10	Monitoring	162
3.12.8	PULSAR	163
3.12.9	Custom Constellation	163
3.12.9.1	General	164
3.13	Settings: Vehicle	164
3.13.1	Body	164
3.13.1.1	Antenna	181
3.13.1.2	Elevation Mask	185
3.14	Settings: Interference	186
3.14.1	Advanced Jammer	186

3.14.1.1 Simplified Transmitter	187
3.14.1.2 Dynamic Transmitter	187
3.14.1.3 IQ-File Jammer	199
3.14.1.4 Multi-band Jammer	200
3.14.2 Advanced Spoofing	202
3.14.2.1 Spoofing instance	203
3.14.2.2 Truth instance	204
3.14.2.3 Additional Jamming + Spoofing Resources	205
3.15 Receiver	205
3.16 Map	208
3.17 Automate	210
3.17.1 Application Programming Interface (API)	211
3.17.1.1 Python	214
3.17.1.2 C++	217
3.17.1.3 C#	217
3.17.1.4 Vehicle Trajectory	217
3.17.2 Skydel Script	219
3.17.2.1 Export To TSV	221
3.18 Basic Interference	222
3.19 SNMP Support	224

CHAPTER 4

Hardware-in-the-Loop (HIL)	227
4.1 Hardware-in-the-Loop (HIL)	228
4.1.1 Additional HIL Resources	229
4.2 Time Reference	229
4.3 HIL Sequence Diagram	230
4.4 Code Example	232
4.5 Latency	235
4.5.1 Engine Latency	236
4.5.2 HIL Latency	236
4.6 HIL Graph	239
4.6.1 How it works	239
4.6.2 Common Patterns (Extrapolation)	246
4.6.2.1 Optimal	247

4.6.2.2 Tjoin Value Too Large	247
4.6.2.3 Jitter	249
4.6.2.4 Late Sample	251
4.6.2.5 Falling Behind / Catching Up	252
4.7 Sending Positions in Advance	253
4.7.1 Common Patterns (Interpolation)	254
4.7.1.1 Optimal	254
4.7.1.2 Time Offset Too Large	256
4.7.1.3 Time Offset Too Small (or Sampling Rate Too Low)	256
4.7.1.4 Jitter	257
4.7.1.5 Lost Sample	258

CHAPTER 5

Timing	259
5.1 Introduction to Timing	260
5.2 Single Skydel Setup	262
5.2.1 Normal Start	262
5.2.2 Arm & Start	263
5.2.3 HIL Start	264
5.2.4 Sync With External PPS	265
5.3 Main/Worker Setup	265
5.3.1 Main/Worker Normal Start	265
5.3.2 Main/Worker Sync With PPS	266
5.4 Timing Receiver Setup	268
5.5 Trigger (USRP X300 AUX I/O)	269

CHAPTER 6

Plugins	273
6.1 Introduction to Plug-ins	274
6.1.1 Management	274
6.1.2 Incompatibility	275
6.1.3 License Activation	276
6.2 Rinex Observation Logger	278
6.2.1 Introduction	278
6.2.2 Management	278
6.2.3 Details	280

6.3 Terrain Obscuration	280
6.3.1 Introduction	280
6.3.2 General	281
6.3.3 Visualizer (Interference/Spoofers)	282
6.3.4 Visualizer (GNSS)	283
6.3.5 Limitations	284
6.3.6 Downloading SRTM 1 Arc-Second Elevation Data	284

CHAPTER 7

Software Installation	289
-----------------------------	-----

7.1 Software Configuration: Linux Ubuntu	290
7.1.1 General Parameters	290
7.1.2 Nvidia GPU Driver	291
7.1.2.1 Nvidia GPU Driver for Ubuntu 18.04, 20.04, 22.04, and 24.04.1 (Automatic)	292
7.1.2.2 Network Card Driver: 10 GbE Intel X520-DA2	293
7.1.2.3 Dektec Drivers	294
7.1.2.4 Safran Skydel Installation	294
7.2 Skydel-SDX Folder	295

APPENDIX

Appendix	297
8.1 Technical Support	298
8.1.1 Regional Contact	298
8.2 References	298
8.2.1 Safran Skydel Download Page	298
8.2.2 Skydel Driver/Firmware Page	298
8.3 IQ Files	299
8.3.1 IQ File Data Format	299
8.3.2 IQ File Metadata	299
8.3.3 Importing an IQ File	299
8.4 Important changes introduced in version 21.3	301
8.4.1 SV ID used in the GUI	302
8.4.2 SV ID used in the API	304
8.5 NMEA Serial Port Logging	306
8.5.1 Introduction	306

8.5.2 Configure the serial port	307
8.5.3 Enabling serial port distribution	308
8.5.4 Alignment between PPS and NMEA messages	309
8.5.5 NMEA message type	311
8.6 List of Tables	311
8.7 List of Images	311

INDEX

CHAPTER 1

Introduction

The following topics are included in this Chapter:

1.1 What is Skydel?	2
1.2 Help	2
1.3 Acronyms	3
1.4 Basic GNSS Simulation Concepts	4

1.1 What is Skydel?

Your GSG-8 Gen2 platform is powered by the Skydel simulation engine software. Skydel is a software application that uses GPU-accelerated computing to generate GNSS signals in real-time. Skydel generates signals in the form of I/Q data. This data can be saved to disk for offline analysis, or it can be pushed to an SDR in real-time to transform the I/Q data into RF at the appropriate carrier frequency.

1.2 Help

To request technical assistance, ask questions, or provide feedback on how to improve Skydel or this user manual, please contact Safran at simulationsupport@nav-timing.safrangroup.com or via the user forum at learn.safran-navigation-timing.com. To stay up to date on the latest Skydel news and information, please visit our website: www.safran-navigation-timing.com. Additional documentation can be found on the [Safran Support Documents](#) webpage as well as the Skydel User Forums: learn.safran-navigation-timing.com.

1.2.1 About This Manual

The Skydel User Manual explains how to configure and use Skydel with different hardware setups and operating systems.

This user manual is organized into the following sections:

- » ["Using Skydel" on page 15](#): Explains how to operate Skydel.

1.2.1.1 GSG-8 Gen2 Resource

If you are using Skydel on a turnkey solution, you can find additional information here:

GSG-8 Gen2: GSG-8 Gen2 Getting Started Guide

1.2.2 Additional Resources

Here are some additional resources that can help you get started when running your first GNSS simulation:

- » [Creating a GNSS Test Plan](#)
- » [A Guide for Testers of GPS Devices and Systems](#)
- » [GNSS Spectrum Status \(blog\)](#)
- » [The GNSS Spectrum \(infographic\)](#)
- » [Basic GNSS Tests: Time to first Fix \(TTFF\)](#)
- » [Upgrading Skydel](#)

1.3 Acronyms

Acronym	Description
AltBOC	Alternate Binary Offset Carrier
BIOS	Built In Operating System
BOM	Bill Of Materials
CPU	Central Processing Unit
CUDA	Compute Unified Device Architecture
DAC	Digital to Analog Converter
DUT	Device Under Test
FPGA	Field Programmable Gate Array
FTP	File Transfer Protocol
GBAS	Ground Based Augmentation System
GNSS	Global Navigation Satellite System
GPS	Global Positioning System
GPSDO	GPS Disciplined Oscillator
GPU	Graphical Processing Unit
GSG	GNSS Signal Generator is a device that is able to create simulated satellite signals and generate real RF signals
I/Q (IQ)	Amplitude of In-Phase (I) and Quadrature (Q) of carrier
JTAG	Joint Test Action Group
LEO	Low Earth Orbit

Acronym	Description
MEO	Medium Earth Orbit
MIMO	Multiple Input Multiple Output
MS	Millisecond
MTU	Maximum Transmission Unit
NI	National Instruments
NMEA	National Marine Electronics Association
OCXO	Oven-Controlled Crystal Oscillator
PC	Personal Computer
PPS	Pulse Per Second
RAM	Random Access Memory
RF	Radio Frequency
RTK	Real-Time Kinematic
SBAS	Satellite Based Augmentation System
SDR	Software Defined Radio
SFP (SFP+)	Small Form-factor Pluggable
SMA	SubMiniature version A
TX	Transmission
TX/RX	Transmission/Reception
UHD	USRP Hardware Driver
USB	Universal Serial Bus
USRP	Universal Software Radio Peripheral
VCTCXO	Voltage Controlled, Temperature Compensated Oscillator

1.4 Basic GNSS Simulation Concepts

Performance testing of GNSS equipment designs is crucial in today's complex RF landscape. The Skydel simulation engine was designed to reproduce a range of

satellite constellations, realistic conditions, and even attacks. Skydel excels at recreating a broad variety of real-world scenarios.

To run your first successful simulation with Skydel, you don't need to read this entire manual. You can start by reading the Power Levels: Live Sky vs. Simulation section (below) and then jump directly to "Running Your First Simulation " on page 50.

1.4.1 Power Levels: Live Sky vs. Simulation

The main objective of a GNSS simulator is to create a RF signal identical to the "Live Sky" at the GNSS receiver's RF input connector. The next 2 diagrams depict the difference between the propagation of the real signal and the simulated signal (using a USRP SDR as an example).



Figure 1-1: Propagation of the real GNSS signal from the satellite to the GNSS receiver

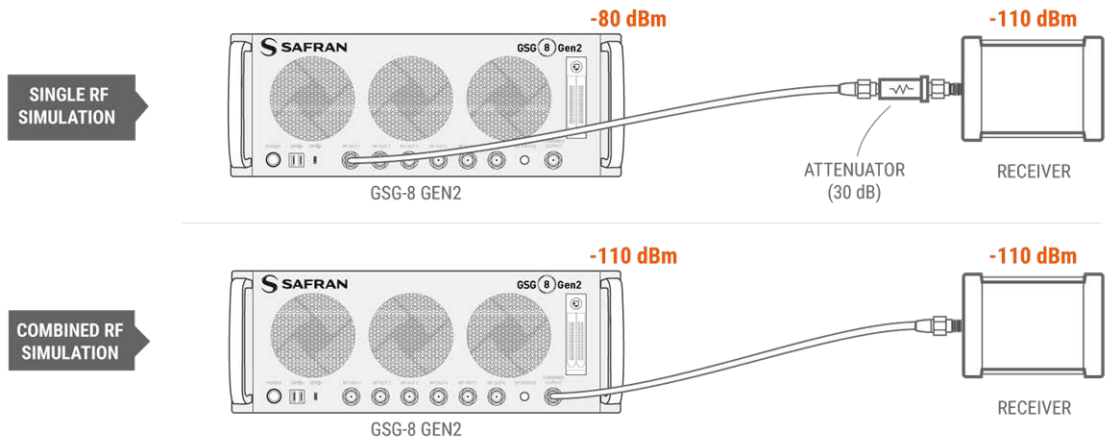

Figure 1-2: Propagation of the simulated GNSS signal from GSG-8 Gen2 to the GNSS receiver

Caution: As you can see in the simulation case, the signal power level can be much higher at the output of the SDR compared to the live sky. We strongly recommend that you:
Use attenuators to avoid damaging your GNSS receiver;

1.4.2 Data Flow (IQ Data)

The Skydel simulation engine creates a digital signal (made of millions of IQ samples per second). This signal is converted to an analog signal (and then to RF).

IQ data is extremely useful for the following uses:

- » Playback: an IQ file (or multiple) can be used as a recording.
- » Spoofing: an IQ file can be used as a spoofed signal along with a jamming transmitter.
- » Software-in-the-loop: an IQ File can be sent to a software-defined GNSS receiver without having to go through digital to analog and analog to digital conversion.
- » Research: an IQ file can be processed, modified, and combined with other IQ files.
- » CRPA: User can create multiple IQ files, one for each element of the CRPA.

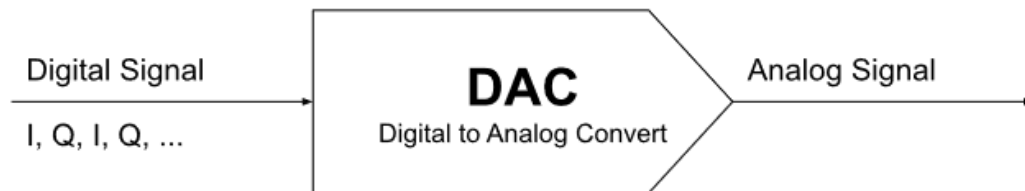

Figure 1-3: IQ Signal Generation. For more on IQ file formats, see the ["IQ Files" on page 299](#) appendix.

1. Skydel, through a computer setup, generates real-time I/Q samples that represent the GNSS baseband signals;
2. The I/Q samples are pushed over the transport link (Ethernet or USB);
3. The I/Q samples are queued in the SDR buffer. The SDR pulls the samples from the buffer at a steady rate and converts them to RF;
4. When the SDR has more than one output, the signals are combined into a single RF cable;
5. The RF signal is attenuated before it is sent through a DC Block and reaches the GNSS receiver being tested.

1.4.3 Additional Resources

Here are some additional resources that can help you get started with your GNSS simulation:

- » [A Guide for Testers of GPS Devices and Systems ↗](#)
- » [Creating a GNSS Test Plan ↗](#)
- » [Create a Basic GNSS Simulation Scenario \(GSG-7/8\) ↗](#)
- » [Basic GNSS Tests: Time to first Fix \(TTFF\) ↗](#)

BLANK PAGE.

CHAPTER 2

GSG-8 Gen2 DESCRIPTION

The Chapter presents an overview of the Skydel GSG-8 Gen2 Expert GNSS Simulator, its capabilities, main technical features and specifications.

The following topics are included in this Chapter:

2.1 GSG-8 Gen2 Specifications	10
2.2 Safety Notes	11

2.1 GSG-8 Gen2 Specifications

This section provides the specifications for your GSG-8 Gen2.

2.1.1 Hardware Parts

Component	Description
Power Supply	Seasonic PRIME PX-1600 ATX 3.0 - 80PLUS Platinum
CPU	AMD Ryzen Threadripper PRO 7975WX
Memory	16GB 5600MHZ DDR5 ECC REG CL46 (x8)
Drive	Samsung 990 Pro 2 TB M.2-2280
GPU	NVIDIA RTX 4000 ADA
Reference Clock	Safran CDM-7 Full Height
SDR	DekTec DTA-2116 (up to 6x)
Removable Disk	ToughArmor Icy Dock MB834MK-B V2 - 2 bays M.2 NVMe SSD PCIe 4.0 One disk is pre-filled, and the other is available for the user to mount. the GSG-8 Gen2's disks are removable to ensure data security.

2.1.2 CDM-7 Information

The GSG-8 Gen2 contains an Safran CDM-7 to distribute a 10 MHz reference clock and 1PPS signals throughout the integrated SDRs.

Safran's CDM-7 clock distribution and timing reference module provides up to seven devices that need precise synchronization, and includes the following features.

- » Timing and frequency source with 5-way (half-height) or 7-way (full-height) distribution of 10MHz and 1PPS signals.
- » PCIe form factor for rack-mount or desktop PC.
- » Two operating modes: internal clock and synchronous external.
- » Supports standalone operation with 12V DC power supply.

For more information on how to set the CDM-7 clock mode within Skydel, please refer to "[CDM-7](#)" on page 45

2.1.3 Software

Component	Description
Operating System	Ubuntu 22.04.1
Username	skydel
Password	Skydel123
GNSS Simulation Software	Skydel





2.1.4 GNSS Inputs + Outputs



10 MHz clock	Input	BNC Connector
10 MHz clock	Output	BNC Connector
1 PPS	Input	BNC Connector
1 PPS	Output	BNC Connector
GNSS Antenna	Input	SMA Connector
GNSS Signal Out	Output (Front Panel)	Type N Connector

2.2 Safety Notes

Safety: Symbols Used

Table 2-1: Safety symbols used in this document, or on the product

Symbol	Signal word	Definition
	DANGER!	Potentially dangerous situation which may lead to personal injury or death! Follow the instructions closely.
	CAUTION!	Caution, risk of electric shock.
	CAUTION!	Potential equipment damage or destruction! Follow the instructions closely.
	NOTE	Tips and other useful or important information.

Symbol	Signal word	Definition
	MULTIPLE POWER SOURCES	This equipment may contain more than one power source: Disconnect all power supply cords before removing the cover to avoid electric shock.
	EQUIPOTENTIALITY	Identify the terminal(s) which, when connected together, bring the various parts of the device to the same potential, not necessarily being the earth (ground) potential.
	STANDBY	Identify the switch by means of which part of the equipment is switched on in order to bring it into the stand-by condition, and to identify the control to shift to or to indicate the state of low power consumption.

SAFETY: Before You Begin Installation



DANGER!

Do not block the air vents which are located on the front panel of the device, the internal temperature might increase and damage the equipment.



DANGER!

The FAN modules must only be replaced by a skilled person. Once reinstated, its screw must be tightened up using a flat-blade screwdriver with at least 0.8Nm to avoid any manual manipulation.



DANGER!

Replacement of a power supply module has been intended only for occasional use by a skilled person. Hazardous energy inside the device might be accessible when a module is extracted. Do not make any kind of contact with any part inside the unit.

**DANGER!**

Installation of this product must be located in restricted access areas where only skilled persons are authorized. This product is not to be installed by the user/operator. Installation of the equipment must comply with local and national electrical codes.

**DANGER!**

This equipment must be earth grounded. Never defeat the ground connector or operate the equipment in the absence of a suitably installed earth ground connection. Contact the appropriate electrical inspection authority or an electrician if you are uncertain that suitable grounding is available.



Caution: To increase the lifetime of your device it is recommended to use it in a controlled temperature environment and limit to the ambient condition:

Temperature: -10°C ~ +50°C; Humidity; 0% ~ 90% RH



Note: The use of dust covers is recommended for the unused SFP/SFP+ slots.

BLANK PAGE.

CHAPTER 3

Using Skydel

This chapter outlines the complete Skydel Software-Defined GNSS Simulator, including basic setup, functionality, and advanced settings.

The following topics are included in this Chapter:

3.1 Launching	16
3.2 Interface	17
3.3 Main Window Subtabs	19
3.4 Licensing	29
3.5 Preferences	32
3.6 Configurations	48
3.7 Running Your First Simulation	50
3.8 Settings: Overview	57
3.9 Settings: Output	63
3.10 Settings: Start Time	73
3.11 Settings: Global	79
3.12 Settings: Constellations	105
3.13 Settings: Vehicle	164
3.14 Settings: Interference	186
3.15 Receiver	205
3.16 Map	208
3.17 Automate	210
3.18 Basic Interference	222
3.19 SNMP Support	224

3.1 Launching

3.1.1 Splash Screen

A splash screen will display licensee information stored in the USB dongle (or license encrypted file if you are not using a dongle).



Click Continue to open Skydel.

3.1.2 Welcome Screen

After launching Skydel, the welcome screen lets you create a new configuration, open an existing configuration, or reload the last used configuration. You can read the "[Configurations](#)" on [page 48](#) section of this manual for more details. Click New Configuration to access the Skydel main window.

The most common way to use Skydel is to launch a single instance of Skydel. On a Linux system, simply type `skydel-sdx` in the terminal. In Windows, locate Safran's Skydel in the start menu and click on it.



Resources: Learn How To Use Skydel: The Skydel Certification Courses expose learners to new concepts and hands-on experiences. These free, self-paced GNSS Simulation Courses are designed to prepare you for Skydel Certification and other industry-recognized certification exams. These online courses provide the following:

Coursework: Engaging learning experiences with interactive content such as practice quizzes, extra learning materials, videos, and instructions on how to run the software on your own to follow along in the certification courses.

Community: Once registered, you will have access to the Skydel Community Forum. You can ask questions with other students and/or peers as well as interact with instructors.

Proof of Completion: You will receive a shareable .pdf certificate of completion. You will have the ability to share a link with anyone, put it on your resume or integrate into your LinkedIn profile in the Certifications section.

[Register for Skydel Certification Courses here](#)

3.2 Interface

Interface includes the following subsections: "Main Window Subtabs" on page 19, "Constellations" on page 19, "Deviation" on page 19, "Spectrums" on page 20, "Performance" on page 20, "HIL" on page 25, "Status Log" on page 26, "Simulator State" on page 26, and "Command Line Options" on page 27.

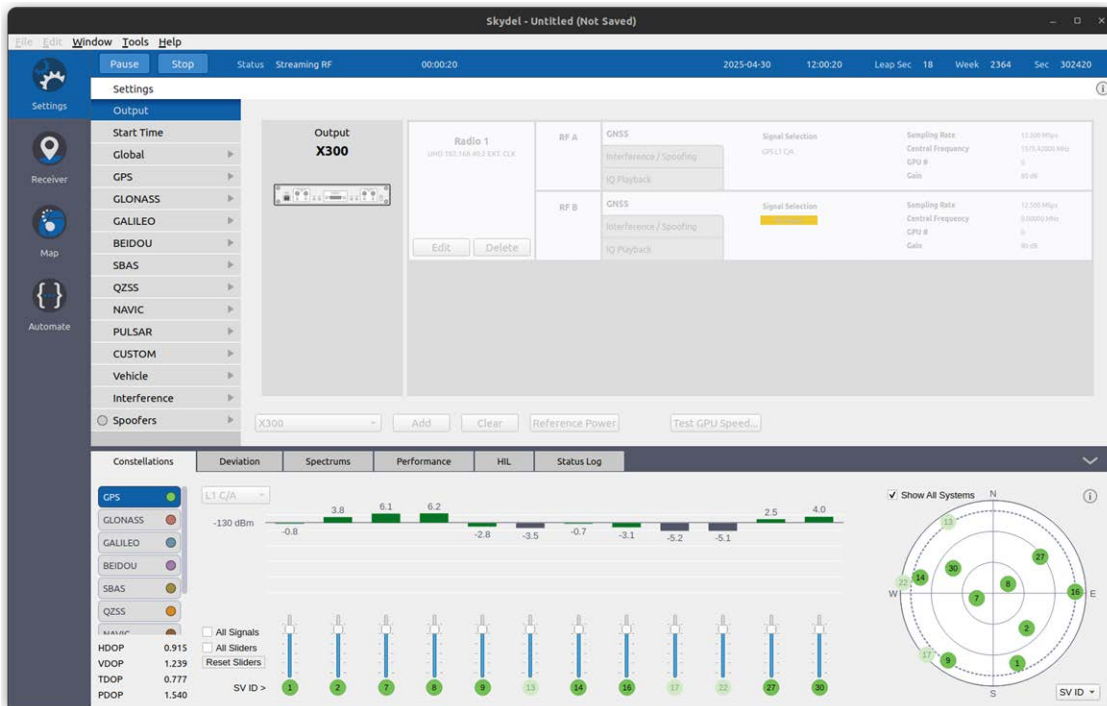

Figure 3-1: Main Window

The Skydel main window contains 5 important areas:

Title Bar

The title bar displays information about the Skydel multi-instance id, configuration name, and whether it is saved or not.

Menu Bar

The menu lets you save or load configurations, edit the preferences, undo or redo changes, etc.

Dashboard

The dashboard is the horizontal blue bar that contains the Start and Arm buttons. It also displays the current simulation elapsed time, the simulator state, and the current simulation time in various formats (Gregorian, GPS week/second).

Main Window Tabs

On the left-hand side, there are 4 Main Window Tabs: Settings, Receiver, Map and Automate. Clicking on a tab will affect the Main Window Tab Content in the center.

Main Window Tab Content

The central content area changes according to the Main Window Tab selection.

3.3 Main Window Subtabs

The Settings, Receiver, and Map Tabs feature a horizontal divider that allows you to divide the display window according to your preferences. The top portion of the window displays content determined by the choice of Main Window Tab (i.e., map, receiver feed, etc.), while the bottom portion offers 5 subtabs corresponding to views of: Constellations, Deviation, Spectrums, Performance and Status Log.

The subtabs panel can be collapsed or expanded using the arrow button located at the far right of the horizontal divider.

3.3.1 Constellations

This subtab information about the GNSS satellites that are simulated. You can find more detailed information in the " [Settings: Constellations](#)" on page 105 section.

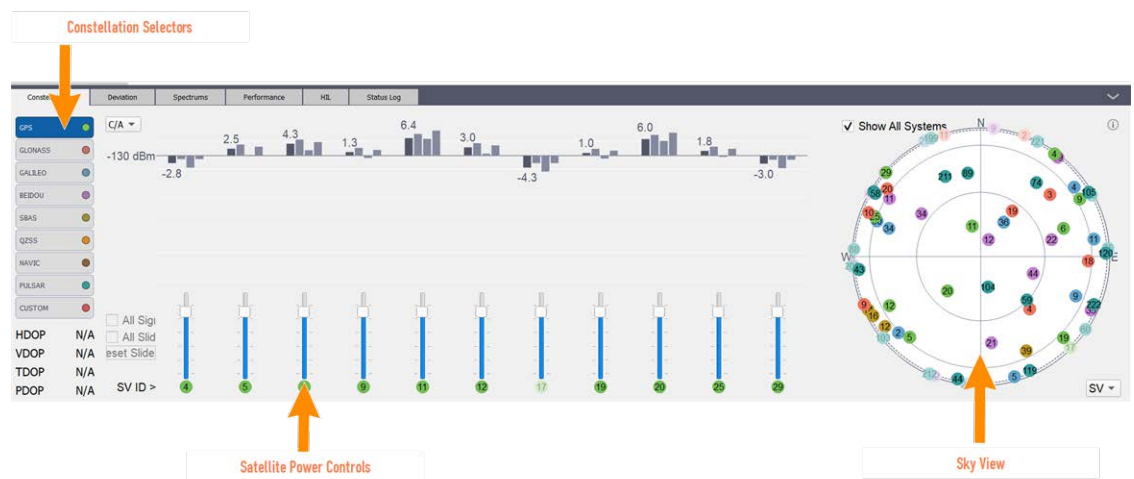

Figure 3-2: Constellations Subtab

Note: If you don't see satellites in the sky view, it may be because the selected constellation is not included in your scenario. See section Output to add signals to your configuration.

3.3.2 Deviation

This subtab displays a graphic, in real-time, showing the deviation between the position generated by the simulator and the position calculated by the receiver under test. This subtab will not display any information unless Skydel is

connected to the NMEA serial port of the receiver under test. See the "Receiver" on page 205 section for more details.

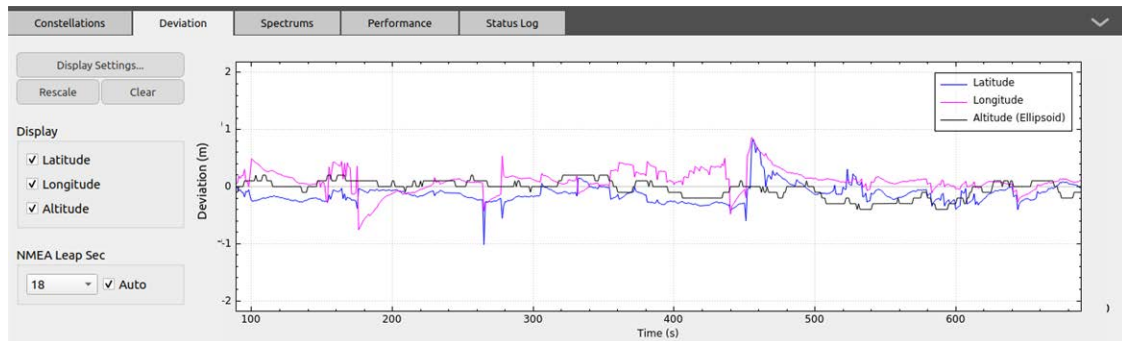

Figure 3-3: Deviation Subtab

3.3.3 Spectrums

This subtab displays the spectrum based on the generated IQ data. It displays an ideal spectrum based on digital data and does not represent the real output at the radio TX connector. This view should not be used for taking precise measurements. However, it is very useful for visualizing the content of each output.

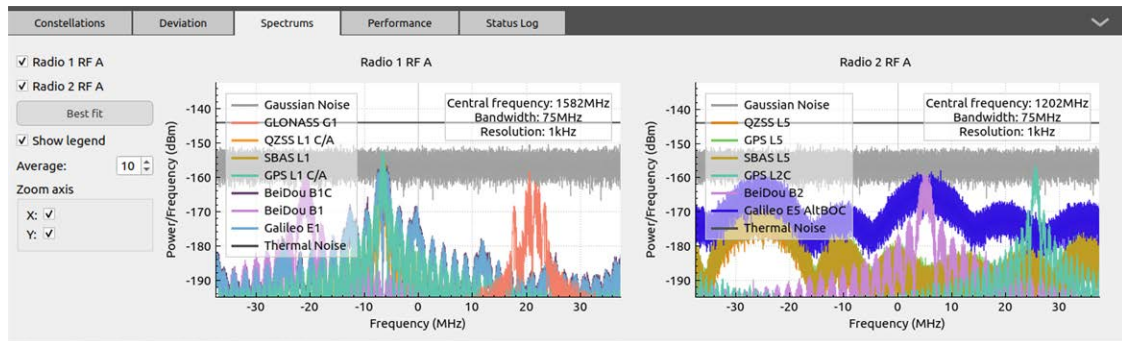

Figure 3-4: Spectrums Subtab - Showing GNSS signals on RF A and B

The Spectrums subtab will display the trace only while the simulation is running. The content that is displayed depends on the scenario.

Note: On a slower computer, it may be necessary to disable the Spectrums. You can change this in the Preferences.

3.3.4 Performance

The Performance subtab is used to have an insight on the system's performance and stability. The right graph is a detailed view on the last second of simulation,

while the left graph is a summary of the last minute of simulation.

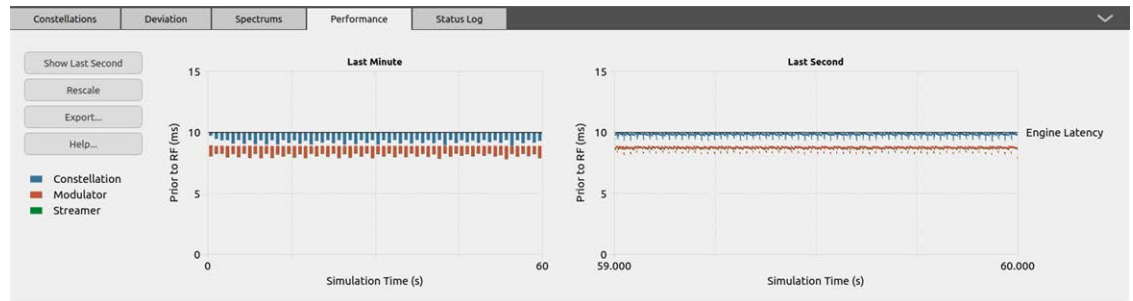

Figure 3-5: Performance Subtab - Showing a minute of simulation

The Skydel real-time engine performs a massive number of calculations in real-time. If you create complex scenarios with many signals, jammers, and spoofers, or if you want to reduce the latency to just a few milliseconds, you might be pushing the hardware to its limit. If at any given time during the execution of a scenario the simulator is unable to perform these calculations in real-time, it may stop and display the following error message in the Status Log: “Streaming buffer underrun”.

The Performance graph helps you visualize how close to the hardware limit your scenario is, before it results in an error. This can be used to confirm that long scenarios will run reliably on the system.

To better understand the graph, it is useful to first understand the principles of how the Skydel real-time engine works. The engine processes the simulation in 1 millisecond chunks, and each of them has to pass through 3 workers:

- » The Constellation Worker
- » The Modulation Worker
- » The Streamer Worker

The combination of these workers is known as the pipeline. The time it takes for a chunk to go through the pipeline is a major factor in determining the latency of the system. Since a chunk is 1 millisecond of simulation, the radio consumes them at a steady rate of 1000Hz (real-time). The real-time engine is allowed to process these chunks in advance, but this is capped by the Engine Latency set in the “[Performance](#)” on page 44 settings. An underrun (also known as underflow) occurs when the engine is unable to provide a chunk to the radio in time.

The Performance graph records the start and finish times when the chunks pass through each worker.

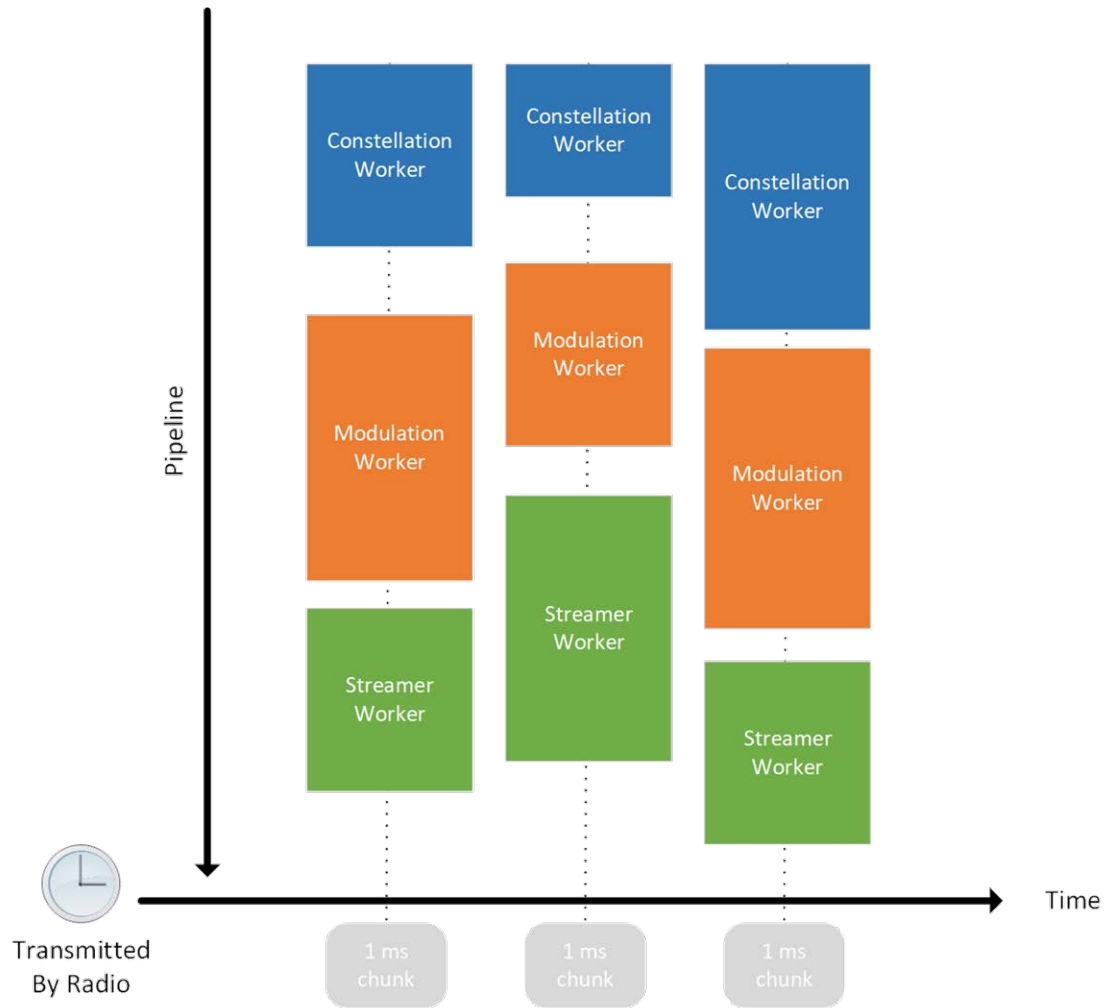

Figure 3-6: Pipeline

The time displayed on the vertical axis shows how far in advance the chunk was processed, compared to the moment it will be transmitted by the radio. As previously stated, the Engine Latency limits how much in advance a chunk can be processed. The traces should therefore always be located under the Engine Latency line.

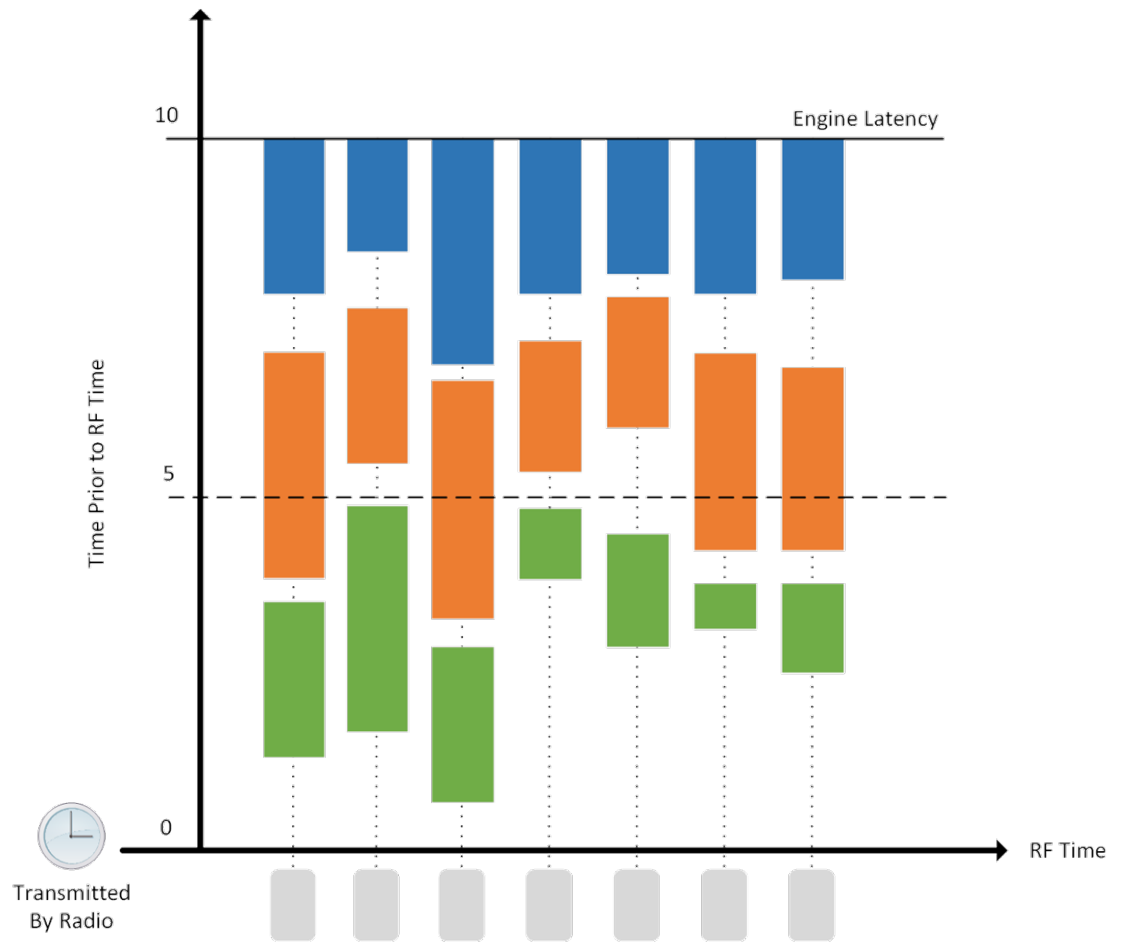

Figure 3-7: Stable Pipeline

A healthy and stable system should always begin to work on a chunk near the Engine Latency threshold. In other words, the blue trace should be as close as possible to the Engine Latency line. If the blue trace is below the Engine Latency, it means the simulator is falling behind; if it doesn't catch up rapidly, an underrun will occur. Depending on the system, it's possible to have the blue trace near the Engine Latency line, but still have the other traces falling down, depending on the specific worker that has the bottleneck.

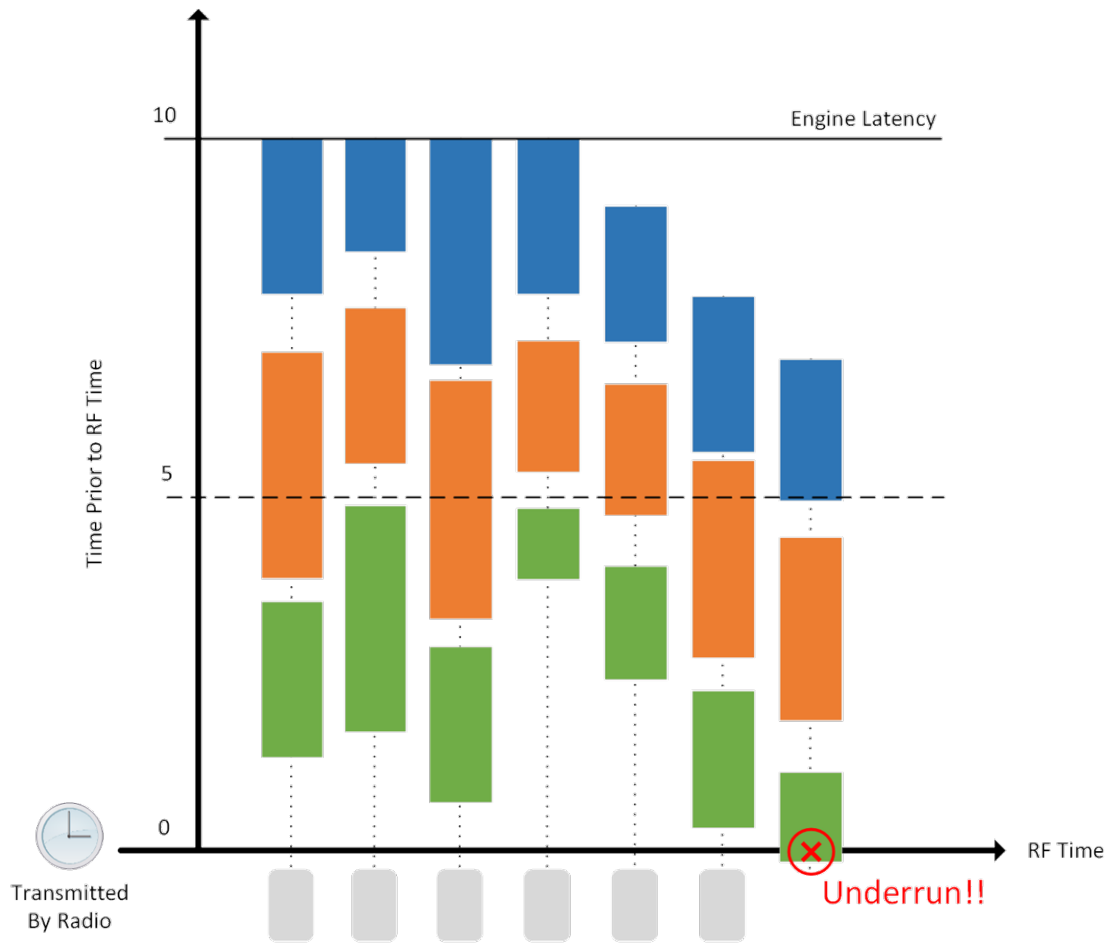

Figure 3-8: Pipeline underrun

You can find the individual chunk traces of the last second in the right graph of the Performance subtab, while the summary graph generates a trace for each second of simulation from the earliest start and latest finish times of each worker. It takes 1000 chunks to make one second of simulation, so the workers are displayed in the detailed graph using thin vertical lines which may appear as a single pixel. It is possible to zoom in the graph in order to see individual traces.

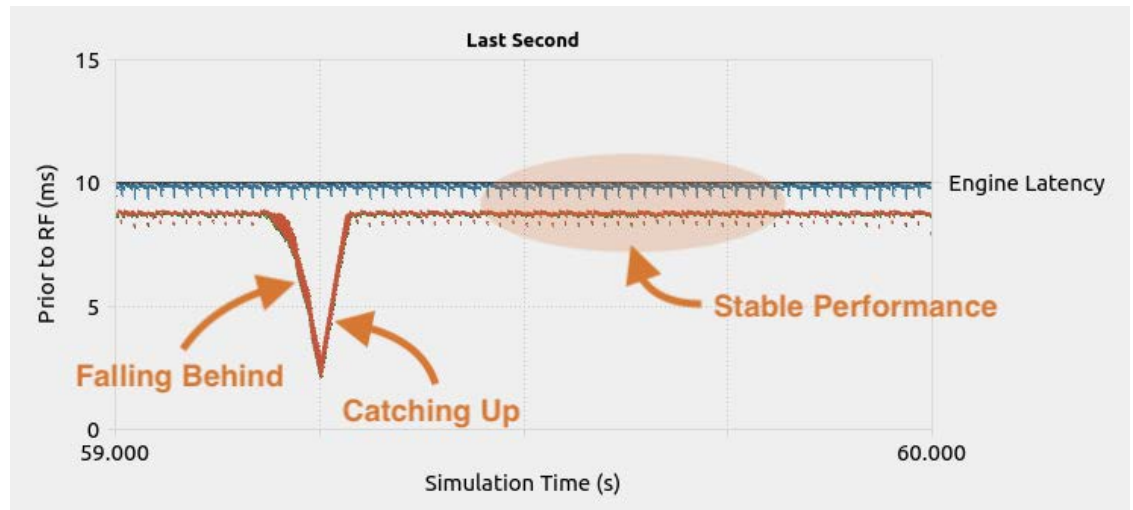

Figure 3-9: Performance Subtab - Showing different scenarios in Last Second graph

There are many factors that can cause the simulation engine to fall back, catch up, and possibly underrun. Some features might require more processing power or interfere with the radio capacity to transport chunks. If you get underruns, try to observe the Performance graph in order to find any pattern that might occur before the error. You might be able to associate the patterns with something in your scenario, such as an excessive transmission of commands in a short period of time, or an external factor, such as another application competing for CPU or GPU time. If you have built your simulator with your own hardware instead of using a turnkey system from Safran, make sure you follow all guidelines to optimize the Operating System and use appropriate hardware. The Skydel engine performs better on Linux, so Windows users will see more glitches on the Performance graphs. For that reason, Linux is strongly recommended for hardware-in-the-loop simulation when low latency is required.

3.3.5 HIL

If your [software license](#) includes [Hardware-In-the-Loop](#) option, Skydel will show the HIL subtab. The graph shown in this subtab is a powerful visualization tool that is designed to make precise diagnosis and give you the confidence the HIL integration is working exactly as you expect. Read the ["HIL Graph" on page 239](#) section for more details.

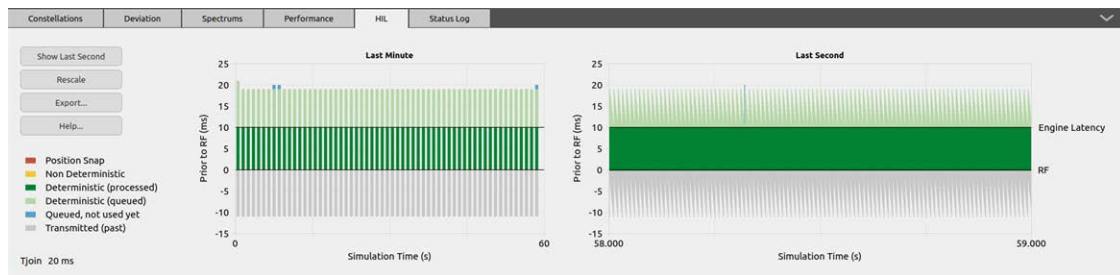

Figure 3-10: HIL Subtab

3.3.6 Status Log

This subtab is complementary to the dashboard which displays the current state of the simulator. Sometimes, it is not enough to know the simulator's state. If the simulator is in an error state, or in an incomplete state, the Status Log will display information to provide additional context.

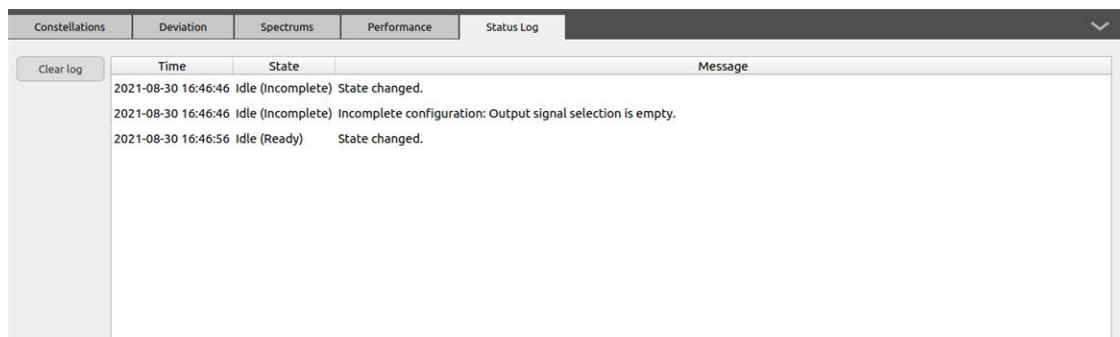

Figure 3-11: Status Log Subtab

3.3.7 Simulator State

The simulator state is visible in the dashboard and the status log subtab. Typically, you will see Ready or Running state. However, there are other states you should be aware of.



Figure 3-12: Dashboard

Ready

Ready means that the simulator is ready to start. Clicking the Start button will begin the simulation. You may get an error if you haven't selected an Output (see ["Settings: Output" on page 63](#)). In this case, Skydel will simply display a message inviting you to add an output and select signals. Clicking the Arm button will

initialize the plug-in instances then the hardware and stay in the Armed state until the user clicks the Start button.

Initializing

Initializing means that the simulator is preparing the plug-in instances for simulation and the radio for streaming; this happens when you click the Start button. Depending on the selected output and plug-in instances, this state may appear for only a fraction of a second or for up to 10 seconds.

Armed

Armed means the hardware is initialized and ready to start. If you clicked the Arm button (instead of the Start button), the simulator will stay in the armed state until you click the Start button. While Skydel is in an armed state, you may change some of the settings. For example, it is possible to move a slider to change the initial power of a satellite before the simulation starts. However, if you are using a timing receiver to synchronize the simulation start time, changes to the settings while in the armed state will be discarded when the simulation starts.

Streaming RF

Streaming RF means that the simulator is running.

Error

Error means that the simulator is in an error state. The simulator will display the "[Status Log](#)" on the [previous page](#) subtab and automatically return to the ready state.

Incomplete

Incomplete means that Skydel is missing the information required to start a simulation. This can happen when a trajectory type such as a track (see "[Track Playback](#)" on page 168) or route (see "[Vehicle Simulation](#)" on page 175) hasn't been created properly. In this case, you will also notice that Skydel does not display the satellites in the sky view. The reason is quite simple: Skydel does not know the receiver position, so it is not able to calculate the elevation and azimuth of the satellites relative to the receiver.

3.3.8 Command Line Options

When starting Skydel, you can add multiple command line arguments and a configuration file name. For example, the following command will launch Skydel, skip the splash screen and automatically load my_config.sdx configuration.

```
skydel-sdx --skip-splash ~/Documents/Skydel-SDX/Configurations/my_config.sdx
```

There are many command line arguments. Use the --help command to get the complete list of commands.

```
skydel-sdx --help
```

Command	Description
skip-splash	Skip the Splash Screen that displays the licensee information.
skip-onboarding	Skip the " Welcome Screen " on page 16 dialog box inviting the user to choose between creating a new configuration, loading an existing configuration, or loading the last used configuration.
reset-window	Reset window state and geometry.
width	Set window width in pixels.
height	Set window height in pixels.
instance-id	If your software license (see " License Feature List " on the facing page) allows multiple instance of Skydel to run simultaneously (see " Launching " on page 16), this command is used to specify the instance id. The instance id is used in the API library to identify which instance of Skydel you want to connect to.
full-screen	Start Skydel in full screen mode (use as much space as possible and hide the title bar).
minimized-window	Start Skydel in minimized window size. Implicitly set skip-splash and skip-onboarding options.
maximized-window	Start Skydel in maximized window size (use as much space as possible but does not hide the window's title bar).
run-in-background	Start Skydel with the window hidden. Implicitly set skip-splash and skip-onboarding options.
log-path	Set the folder where the Skydel log should be stored. ex: --log-path=~/.archives/
output-path	Set the folder where the Skydel Output repertory should be stored.
skip-release-note	Skip the release notes window.
hil-port	Explicitly set the HIL UDP port.



Resources: Learn How To Use Skydel: The Skydel Certification Courses expose learners to new concepts and hands-on experiences. These free, self-paced GNSS Simulation Courses are designed to prepare you for Skydel Certification and other industry-recognized certification exams. These online courses provide the following:

Coursework: Engaging learning experiences with interactive content such as practice quizzes, extra learning materials, videos, and instructions on how to run the software on your own to follow along in the certification courses.

Community: Once registered, you will have access to the Skydel Community Forum. You can ask questions with other students and/or peers as well as interact with instructors.

Proof of Completion: You will receive a shareable .pdf certificate of completion. You will have the ability to share a link with anyone, put it on your resume or integrate into your LinkedIn profile in the Certifications section.

[Register for Skydel Certification Courses here](#)

3.4 Licensing

3.4.0.1 License Feature List

You can review your current Skydel licenses by following these steps:

1. Open Skydel;
2. Click on the Help tab;
3. Select About Skydel...

The following information will be displayed:

- » Skydel Version, SHA code, and release date;
- » License dongle serial number;
- » Licensee name;
- » Highest version of Skydel that you can upgrade to with the current license;
- » Number of Skydel instances that can run simultaneously (Multi-Instance);

- » Number of spoofing instance(s) allowed;
- » Listing which features are currently enabled with the license.

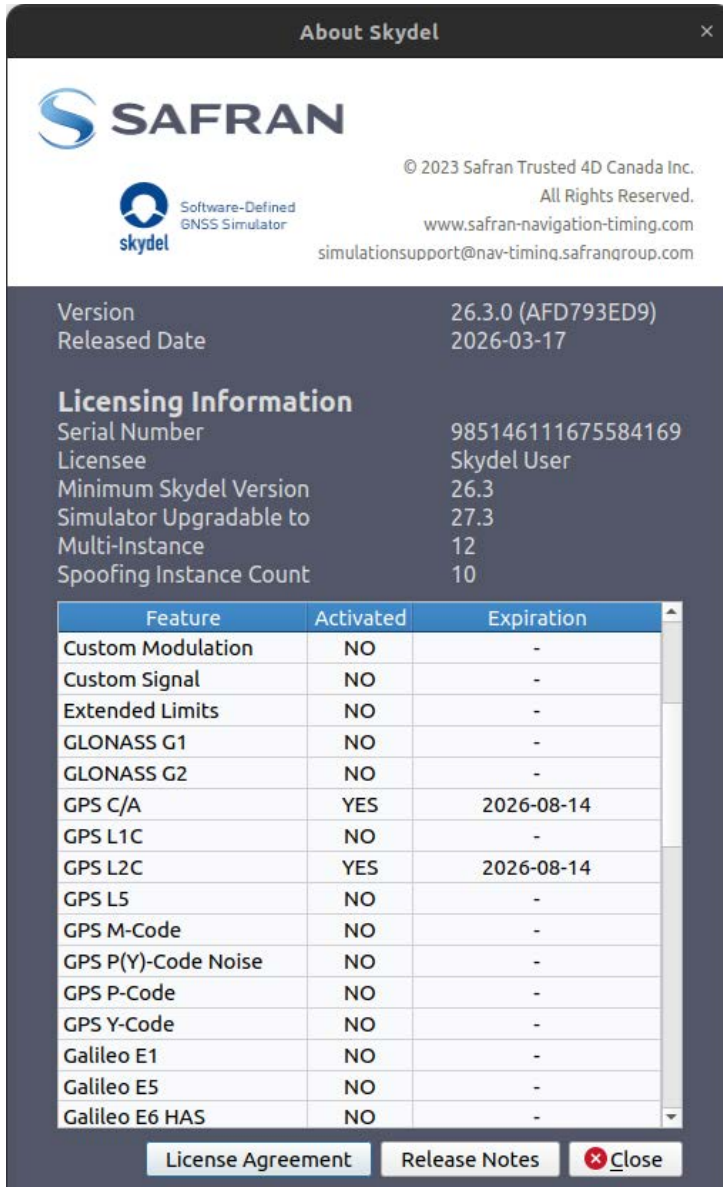

About Skydel

 SAFRAN

© 2023 Safran Trusted 4D Canada Inc.
All Rights Reserved.
www.safran-navigation-timing.com
simulationsupport@nav-timing.safranqroup.com

Software-Defined
GNSS Simulator

Version: 26.3.0 (AFD793ED9)
Released Date: 2026-03-17

Licensing Information

Serial Number: 985146111675584169
Licensee: Skydel User
Minimum Skydel Version: 26.3
Simulator Upgradable to: 27.3
Multi-Instance: 12
Spoofing Instance Count: 10

Feature	Activated	Expiration
Custom Modulation	NO	-
Custom Signal	NO	-
Extended Limits	NO	-
GLONASS G1	NO	-
GLONASS G2	NO	-
GPS C/A	YES	2026-08-14
GPS L1C	NO	-
GPS L2C	YES	2026-08-14
GPS L5	NO	-
GPS M-Code	NO	-
GPS P(Y)-Code Noise	NO	-
GPS P-Code	NO	-
GPS Y-Code	NO	-
Galileo E1	NO	-
Galileo E5	NO	-
Galileo E6 HAS	NO	-

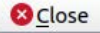
License Agreement Release Notes 



Note: The SHA code and release date in the official software release is most likely to differ from the image above.

3.4.0.2 License Update

A new license file will be required if you purchase additional features. In order to update the license, follow the instructions below.

Generate the License Request file:

1. Open Skydel
2. Go to the Help tab
3. Select the "Update License" menu
4. In the License Request section, generate a license request file using the "Save to file..." button

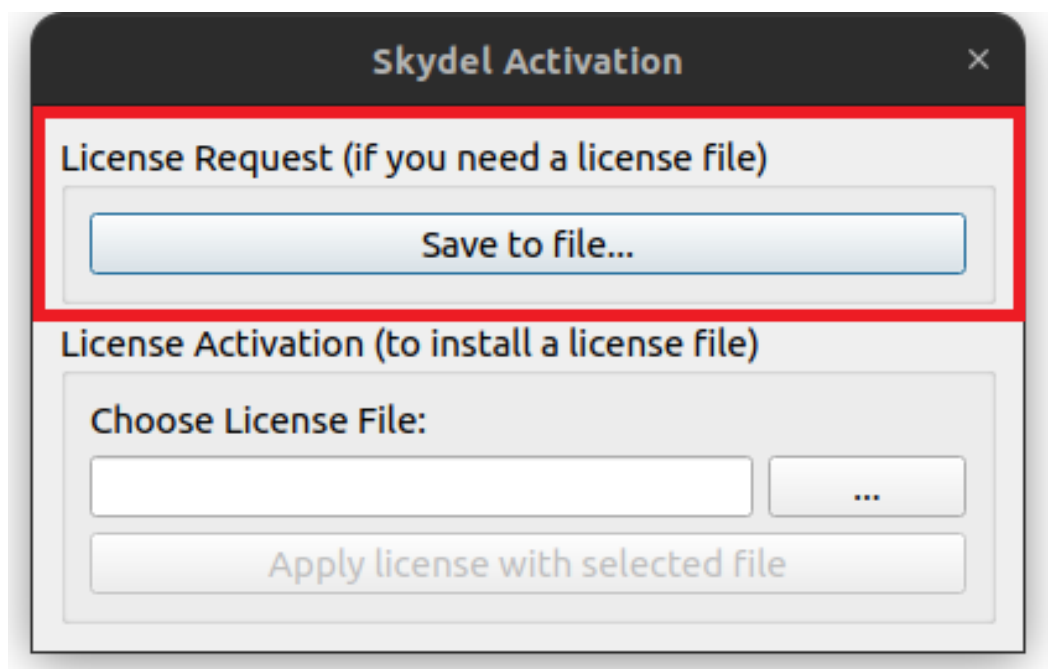

5. Share this license request file with Safran

After receiving, update your license file from Safran:

1. Open Skydel
2. Go to the Help tab
3. Select the "Update License" menu
4. In the License Activation section, select the license file received using the browse "..." button

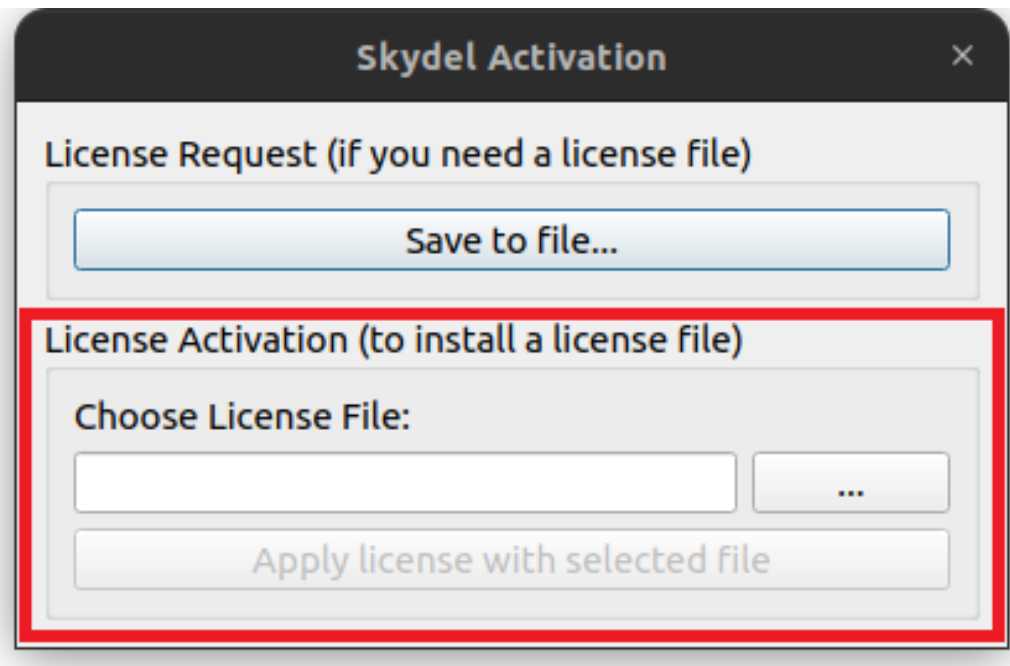

5. Click the "Apply license with selected file" button
6. The license file will update, and Skydel will close.

Reopen Skydel and verify that the new licenses appear correctly in the About screen (as shown in the figure above).

3.5 Preferences

Preferences includes the following subsections: " [General](#)" on the facing page, " [Proxy](#)" on page 35, " [Synchronization](#)" on page 36, " [USRP](#)" on page 40, " [Dektec](#)" on page 42, " [Performance](#)" on page 44, " [CDM-7](#)" on page 45 and " [Custom Constellation](#)" on page 47.

Skydel preferences are global settings that persist across configurations, power cycles, and Skydel instances. These preferences can be accessed from the Edit menu in Skydel.

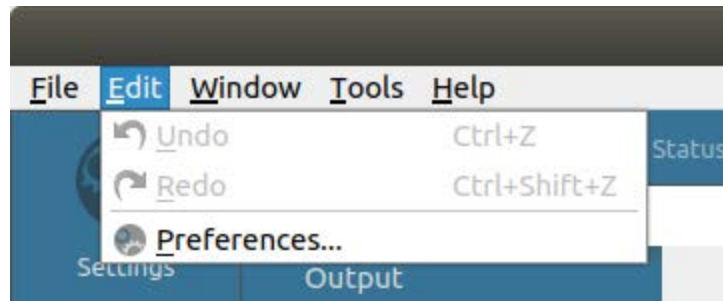

Note: The preferences are organized in categories (tabs). Depending on your license or detected hardware, some categories or specific attributes in a category might not show.

3.5.1 General

You can control the location on your hard drive where Skydel will save configurations, logs, and other data.

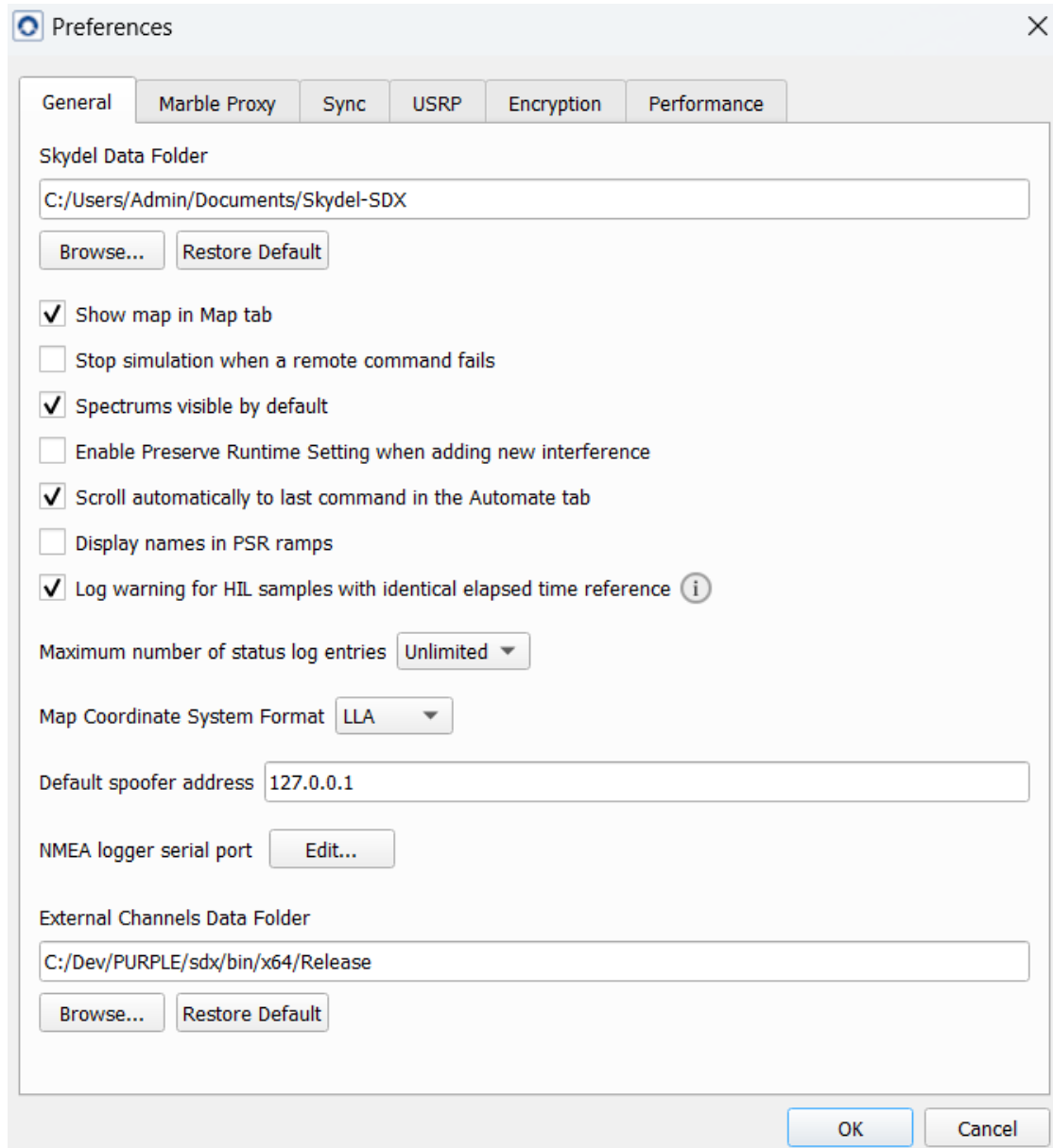

The Spectrums visible by default option can be unchecked if your computer does not have the processing power to generate FFT in real-time or if you would like to reduce the work load on the CPU and GPU.



Note: The streaming buffer preference was moved to the Performance tab.

3.5.2 Proxy

If you are behind a firewall, Skydel will be unable to connect to openstreetmap.org. This will prevent the street maps from properly loading. Contact your network administrator to obtain the proxy information. You can enter this information into the proxy preferences; this will then enable Skydel to connect to openstreetmap.org.

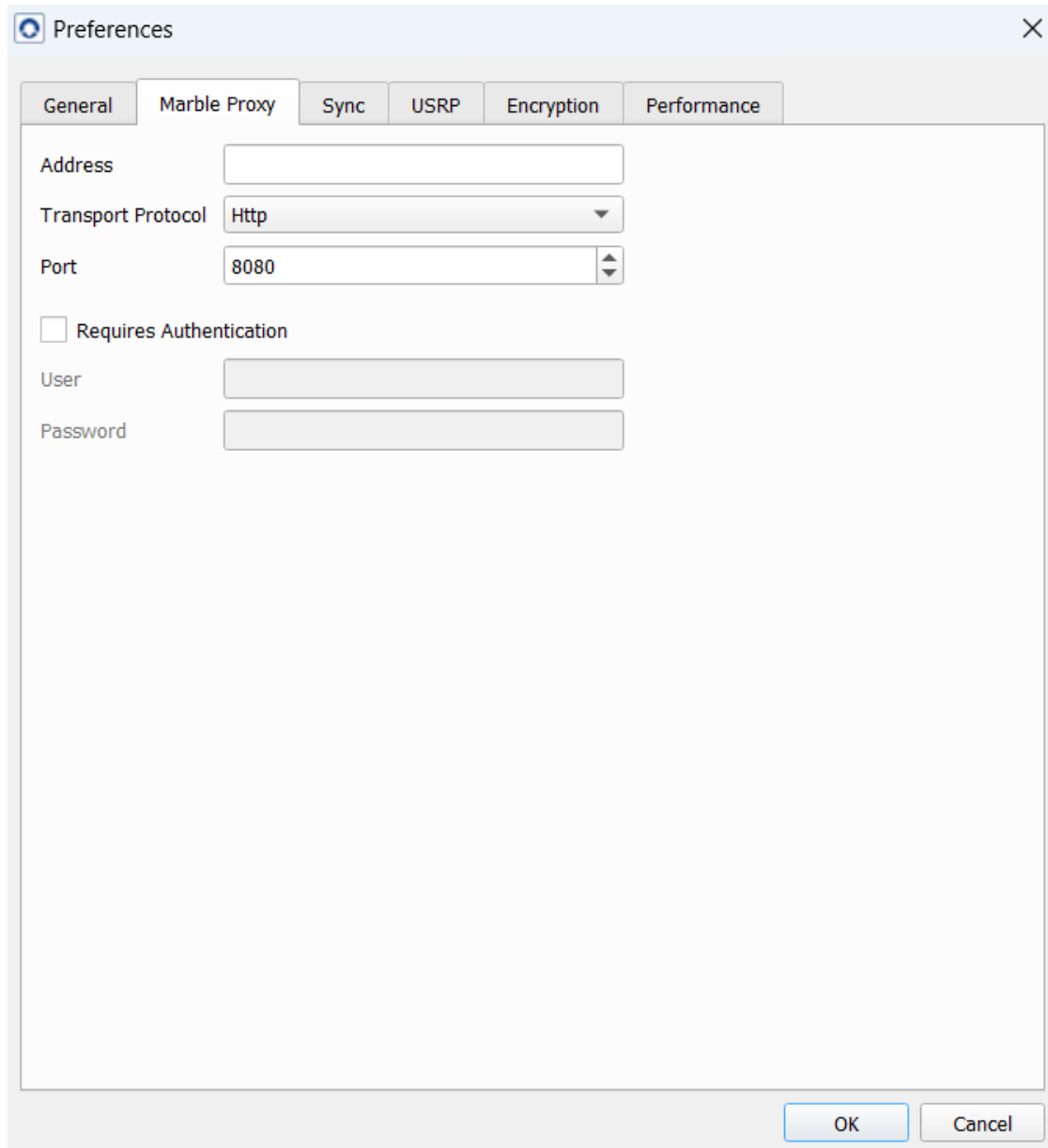

The image shows a screenshot of the 'Preferences' dialog box in Skydel. The 'Marble Proxy' tab is selected, and the following fields are visible:

- Address:** An empty text input field.
- Transport Protocol:** A dropdown menu currently set to 'Http'.
- Port:** A spin box currently set to '8080'.
- Requires Authentication:** An unchecked checkbox.
- User:** An empty text input field.
- Password:** An empty text input field.

At the bottom right of the dialog, there are 'OK' and 'Cancel' buttons.

3.5.3 Synchronization

These preferences are used to synchronize one or many radios with an external timing receiver that can generate a PPS output, such as the OctoClock-G from Ettus. Detailed timing diagrams can be found in the ["Introduction to Timing" on page 260](#) section.

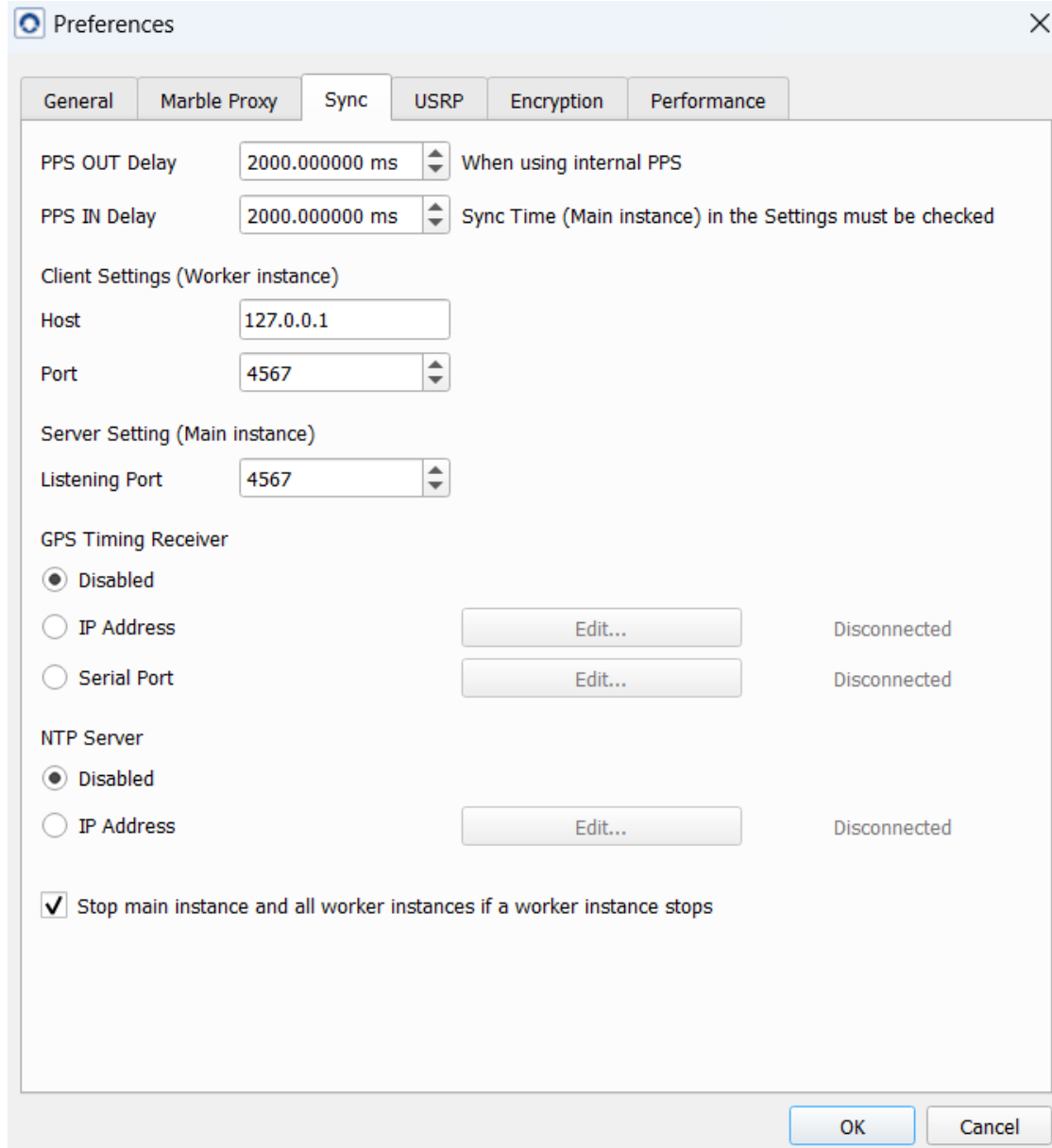

The screenshot shows the 'Preferences' dialog box with the 'Sync' tab selected. The dialog has a title bar with a close button (X) and a refresh icon. Below the title bar are tabs for 'General', 'Marble Proxy', 'Sync', 'USRP', 'Encryption', and 'Performance'. The 'Sync' tab contains the following settings:

- PPS OUT Delay:** 2000.000000 ms (When using internal PPS)
- PPS IN Delay:** 2000.000000 ms (Sync Time (Main instance) in the Settings must be checked)
- Client Settings (Worker instance):**
 - Host:** 127.0.0.1
 - Port:** 4567
- Server Setting (Main instance):**
 - Listening Port:** 4567
- GPS Timing Receiver:**
 - Disabled
 - IP Address (Edit... button, Disconnected)
 - Serial Port (Edit... button, Disconnected)
- NTP Server:**
 - Disabled
 - IP Address (Edit... button, Disconnected)
- Stop main instance and all worker instances if a worker instance stops

At the bottom right of the dialog are 'OK' and 'Cancel' buttons.

3.5.3.1 PPS OUT Delay

This value controls the delay applied to RF transmission to align the RF with the PPS OUT signal. This preference is used only if both Sync Time Main and Sync Time Worker are unchecked. In this case, the SDR is using its own internal PPS reference. See section "[Synchronize Simulators](#)" on page 100 for Sync Time settings details.

The value is calibrated for different sampling rates. The user may adjust this value if it is necessary to offset or align the PPS OUT signal of the SDR with the PPS signal of the GNSS receiver under test. In most cases, the value should be left to its default.



Note: PPS OUT Delay applies only for Ettus X300/X310 or NI USRP-294xR/295xR SDR.

3.5.3.2 PPS IN Delay

This value represents a delay between a reference PPS pulse (on the PPS IN port) and the beginning of the RF signal. The default value is 2000.000000ms. The resolution is 0.000001ms (1ns). The effectiveness of this value differs depending on the radio type you are using (examples follow).

Ettus N310, X300/X310, NI USRP-294xR/295xR

This value is only effective when Skydel is set as a Main in the "[Synchronize Simulators](#)" on page 100 page. The Delay value is transmitted by the Skydel main to each connected worker instance of Skydel, such that they will start at the exact same time. The user can adjust this value if necessary to align the PPS OUT signal of the SDR with the PPS signal of their GNSS receiver.

In most cases, the value should be left to its default.



Note: NOTE: An external PPS must be provided (using an OctoClock-G for example).

Dektec Cards (DTA-2115B and DTA-2116)

This value is effective whether or not Skydel is set as a Main in the "[Synchronize Simulators](#)" on page 100 page. If Skydel is configured to be a Main, the PPS IN Delay value is transmitted by the Skydel main to each connected worker instance of Skydel, such that they will start at the exact same time. The default value is calibrated in order to perfectly synchronize the RF signal to the PPS rising edge at the PPS IN port of either the Dektec DTA-2115B or the DTA-2116.

NOTE 1: When your system uses a Clock/PPS distribution module, you can use the PPS IN value to account for the time delay between the rising edge at the input of the Clock/PPS distribution module to the PPS IN port of the DTA-2115B or DTA-2116. The GSG-8 Gen2 uses the CDM-7 which can be configured within Skydel. See ["Changing the CDM-7 clock mode" on page 46](#).

NOTE 2: The recommended PPS IN Delay setting is the value minus 2000ms (default value). A modulo 1000ms operation is then applied to the resulting delay. Ex: if the value is 3200ms, the effective PPS In delay setting is 200ms.

3.5.3.3 Client / Server Settings

To synchronize radios connected to different computers (see [Multiple Radios - Multi-instance \(RTK\)](#)), each computer running Skydel must talk to each other. If the radios are connected to the same computer, but used by different Skydel instances, each instance must talk to each other as well. In any event, one of the Skydel instances must be defined as the server (main) while each of the other Skydel instances are clients (workers). The client settings control which server the Skydel workers will try to connect to. The server settings control which port the Skydel main will listen on. You can read more details about this in the ["Synchronize Simulators" on page 100](#) section.

3.5.3.4 GPS Timing Receiver

You can synchronize radios to the output of a timing receiver. This can be used to synchronize Skydel to the live sky or some other signal source. The timing receiver can be an OctoClock-G from Ettus or another receiver that supports NMEA messages (required sentences are "\$GPGGA" and "\$GPRMC"). The accuracy of this type of synchronization is better than 50 ns.

Generic GPS Timing Receiver

To connect to a generic GPS timing receiver, you must select the Serial Port option and choose your receiver in the Edit dialog. Under Windows, it will typically be "COM4". Under Linux, it will typically be "ttyACM0". See ["Receiver" on page 205](#) section for more details.

Octoclock-G

To connect to an Octoclock-G, you must select the IP Address option and write the Octoclock-G's IP address in the Edit dialog. Typically, the IP address is "192.168.10.3".

To use the OctoClock-G, connect a GPS signal source (such as live sky) to the GPS antenna port on the front. See section the GPS Timing Receiver section for connection details.



Caution: The OctoClock-G supplies 5 volts through the GPS antenna port. Ensure that you are using a 5-volts antenna! If you are not using a 5-volts antenna, use a DC-Block to isolate the GPS antenna port. If you are using a 12-volts antenna, you will have to use the [DC-Block](#) and find some other means of powering the antenna.

Allow approximately 15 minutes for the GPS lock light to turn green. The following conditions may prevent the GPS lock light from turning green:

- » poor signal level;
- » bad satellite geometry;
- » poor multipath conditions;
- » poor ground plane conditions;
- » inability to download ionospheric data;
- » “time has gone backwards” issue: you may need to restart the OctoClock if the current time of the signal source jumps backward in time.

Once the OctoClock GPS lock light turns green, you can create a time-synchronized simulation. You can read the ["Settings: Start Time" on page 73](#) and the [" Synchronize Simulators" on page 100](#) sections for more details.

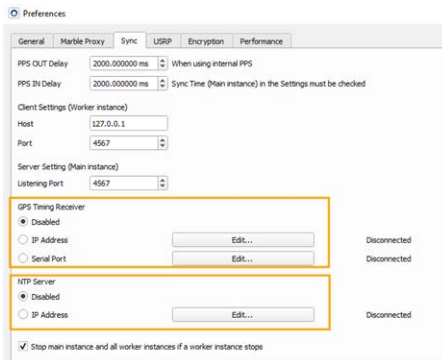

3.5.3.5 NTP Server

Radios can also be synchronized to the time provided by a NTP server. Ideally, a SecureSync can be used (within 1ms on the network) providing 10Mhz and 1PPS. As long as the radio is disciplined by a GPS-aligned 1PPS/10Mhz signal, any NTP server will do.

To connect to an NTP Server, you must select the IP Address option and click Edit to add the server's address.



Note: This feature is only enabled with the SKY-SYNRT (Synchronization with real time) license.

3.5.4 USRP

You can change the USRP preferences to specify preferred default values when adding USRP radios in "[Settings: Output](#)" on page 63.

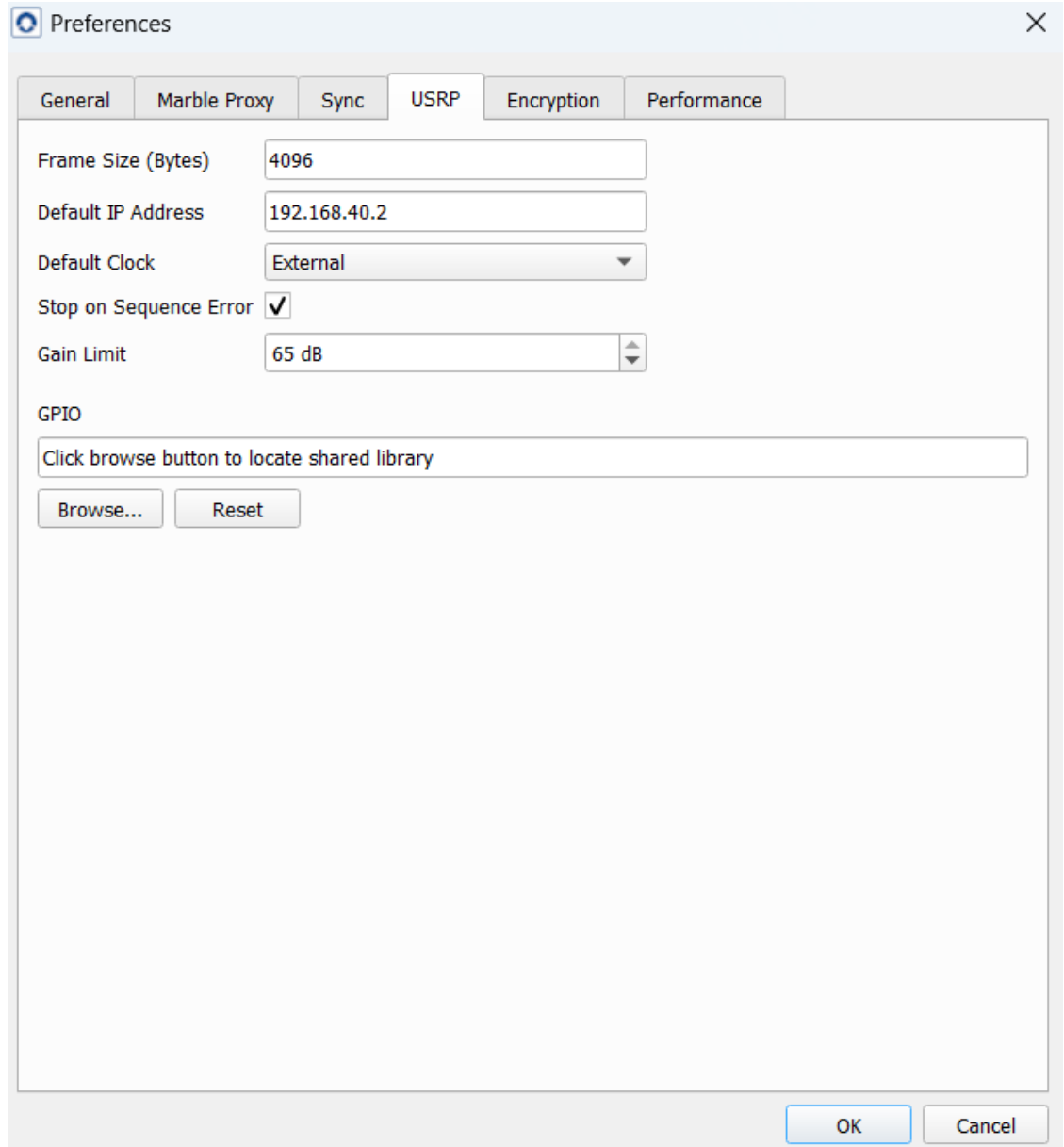

The image shows a 'Preferences' dialog box with the 'USRP' tab selected. The dialog has a title bar with a close button (X) and a tabbed interface with the following tabs: General, Marble Proxy, Sync, USRP (active), Encryption, and Performance. The USRP tab contains the following settings:

- Frame Size (Bytes): 4096
- Default IP Address: 192.168.40.2
- Default Clock: External (dropdown menu)
- Stop on Sequence Error:
- Gain Limit: 65 dB (spin button)
- GPIO: Click browse button to locate shared library (text field)
- Buttons: Browse..., Reset

At the bottom right of the dialog are 'OK' and 'Cancel' buttons.

The frame size is the actual size of the packets transferred over 10 GbE. The X300 SDR performs best when the frame size is set to 8000 bytes, but not all network adapters can support it. If your network adapter does not support this frame size, you will get “Transmission Sequence Error” messages when starting the simulation. The default value is 4096 bytes and it works for all network adapters.



Caution: In all cases, the jumbo packets must be enabled in your network adapter's driver settings. For Linux, see how to set the MTU size in section "[Network Card Driver: 10 GbE Intel X520-DA2](#)" on page 293. For Windows, see how to enable jumbo packets in section [Network Card Driver: 10 GbE Intel X520-DA2](#).

The default IP address setting controls the IP address that will be used by default for any new radio that you add to "[Settings: Output](#)" on page 63. This setting is only provided for convenience. Skydel will always use the IP address specified in the output settings.

The default clock should be set to GPSDO only if the SDR is equipped with a GPSDO precision clock. GNSS simulation requires a high precision 10 MHz source.

Users have the option to stop the simulation or not when a USRP "Sequence Error" occurs. Usually, a sequence error occurs when there is a problem in the communication link between the computer and the radio. The recommended setting (stop on sequence error) is checked by default.



Note: If you run a long simulation (multiple hours or days), the likelihood of dropping a packet increases. The consequence of dropping a packet is a short period (ms) with no RF signal. Since all packets are timestamped, the RF streaming will resume with the next packet at the appropriate time.

The GPIO refers to the AUX. I/O DB-15 connector on the front panel of the USRP X300 radio. These I/O can be set in real-time by a custom library which can be loaded by Skydel. See section "[Trigger \(USRP X300 AUX I/O\)](#)" on page 269 for an example.

3.5.5 Dektec

You can change the mapping between a radio output, identified by its device number, and a Dektec card, identified by its serial number.

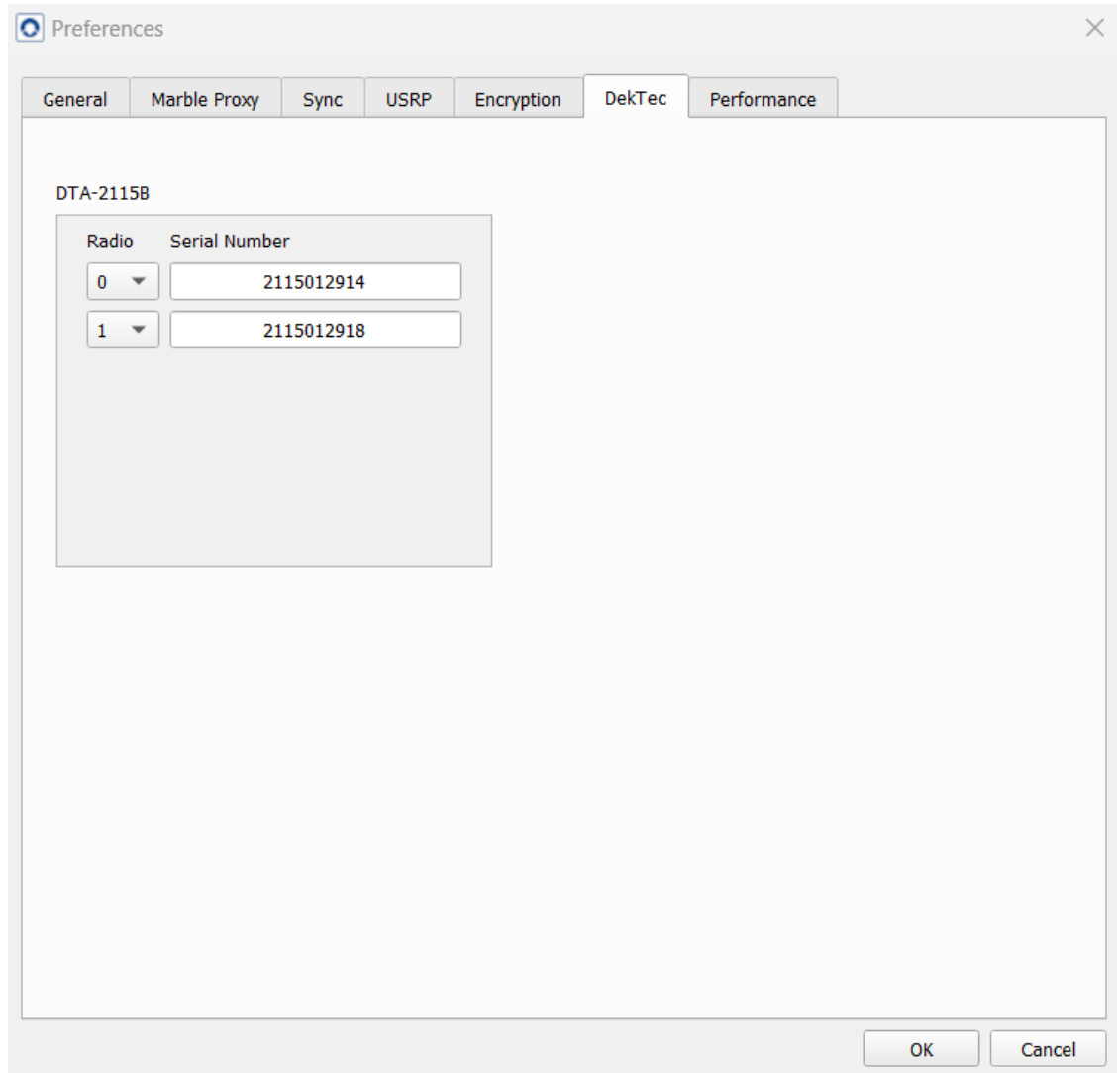

The screenshot shows a 'Preferences' dialog box with a close button (X) in the top right corner. The dialog has several tabs: 'General', 'Marble Proxy', 'Sync', 'USRP', 'Encryption', 'DekTec', and 'Performance'. The 'DekTec' tab is selected. Inside the dialog, there is a section titled 'DTA-2115B'. Below this title is a table with two columns: 'Radio' and 'Serial Number'. The table contains two rows of data:

Radio	Serial Number
0	2115012914
1	2115012918

At the bottom right of the dialog box, there are two buttons: 'OK' and 'Cancel'.

Radio outputs are by default mapped to Dektec cards in ascending serial number order. This dialog allows you to change this order by selecting a different device number from a drop-down in the left column to associate it with the corresponding card serial number in the right column. If the same device number is used in more than one association, you will get a warning message when trying to navigate to another tab or to quit the Preferences dialog box by clicking on the OK button.



Note: The Dektec tab is only shown if at least one Dektec card is present on the system.

3.5.6 Performance

You can change the Engine Latency, the Streaming Buffer, as well as the configurable Optimizations in this tab.

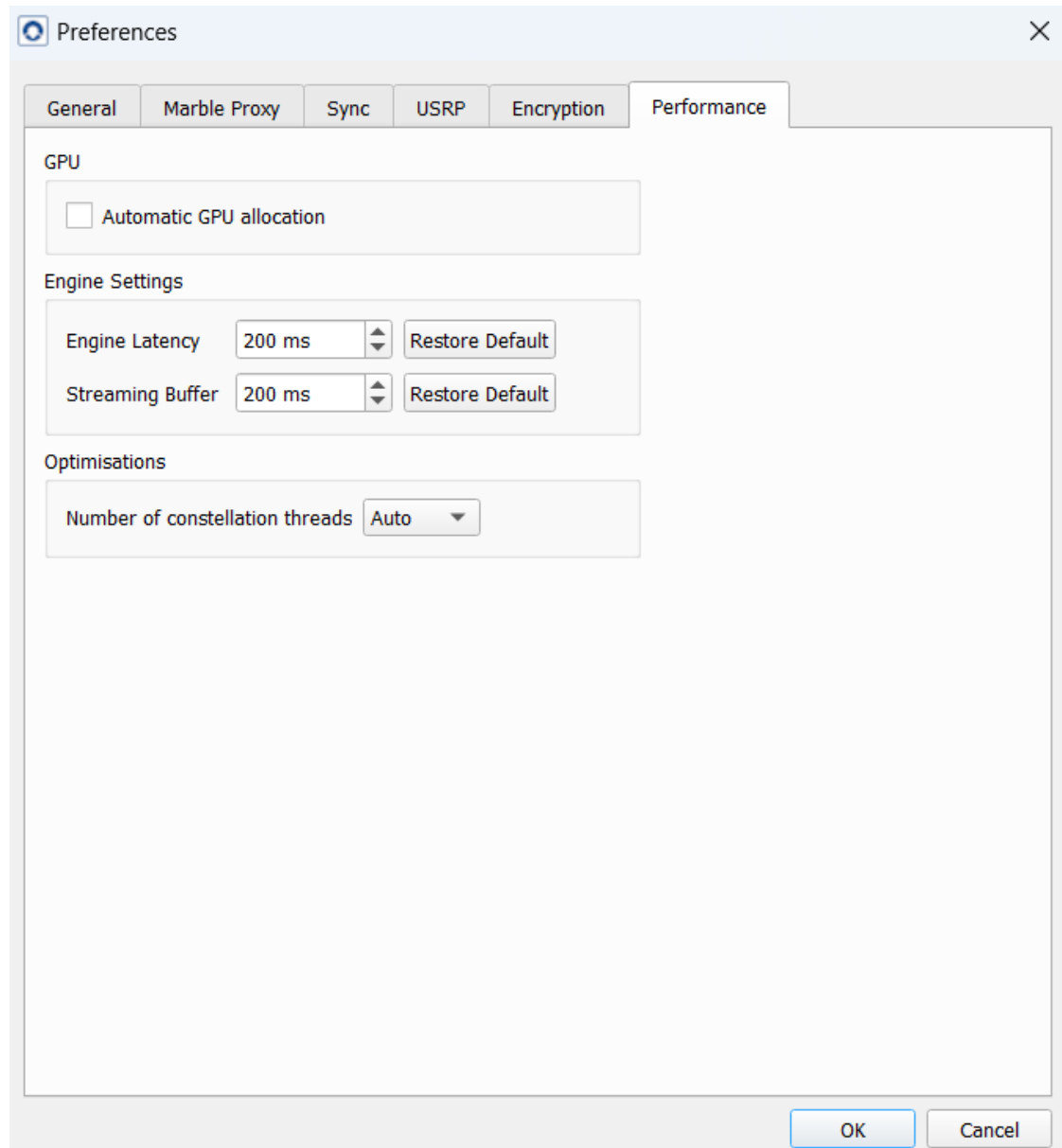

The Automatic GPU Allocation setting automatically assigns your added target to the *least* loaded GPU. This feature helps maintain a balanced workload across multiple GPUs in your system.

Since Skydel version 21.9.0, the Streaming Buffer is no longer as relevant when optimizing a system. The Engine Latency is what gives the Skydel's real-time engine more room to operate, and will ultimately affect the simulation. To know more about the Engine Latency, read the Performance Graph subtab in the "Main Window Subtabs" on page 19 section.



Caution: It is highly recommended to always have the Streaming Buffer larger or equal to the Engine Latency, as doing otherwise can cause underruns on start. You should not edit these preferences unless you need to optimize the latency of your system.

The Number of Constellation Threads setting will by default choose the best configuration for your setup. It is possible to enable or disable the optimization for all the constellation threads used in the setup, or set them individually.



Caution: Since Skydel is scalable and can not be tested for every possible configuration, the option to enable or disable the optimization is available, but should not be changed by most users.

For Advanced Jammers users, you will find in the "Memory" section a preference to preallocate GPU buffers for a given number of AWGN signals. The maximum number of preallocated GPU buffers is 100 per RF Output.

Memory

Number of preallocated AWGN jammers signals Default ▼ 0 ▲▼

3.5.7 CDM-7

The GSG-7 internal clock module is the CDM-7. It can be configured to address different timing use cases from within Skydel.

The module has three modes:

Mode	Description
Internal (default)	This mode uses the internal OCXO of the CDM-7. No additional input required. The CDM-7 will distribute the internal 10 MHz and PPS signals inside the GSG-7.

Synchronous External	This mode requires a 10 MHz and PPS input from an external device to the GSG-7. The CDM-7 will distribute the external 10 MHz and PPS signals inside the GSG-7.
Asynchronous External	This mode requires only a 10 MHz input from an external device to the GSG-7. The CDM-7 will derive its own PPS signal from this external 10 MHz signal. The CDM-7 will distribute the external 10 MHz signal and the derived PPS signal inside the GSG-7.

The default mode is “Internal”.

3.5.7.1 Changing the CDM-7 clock mode

To change the clock mode, open Skydel and select the Preferences menu.

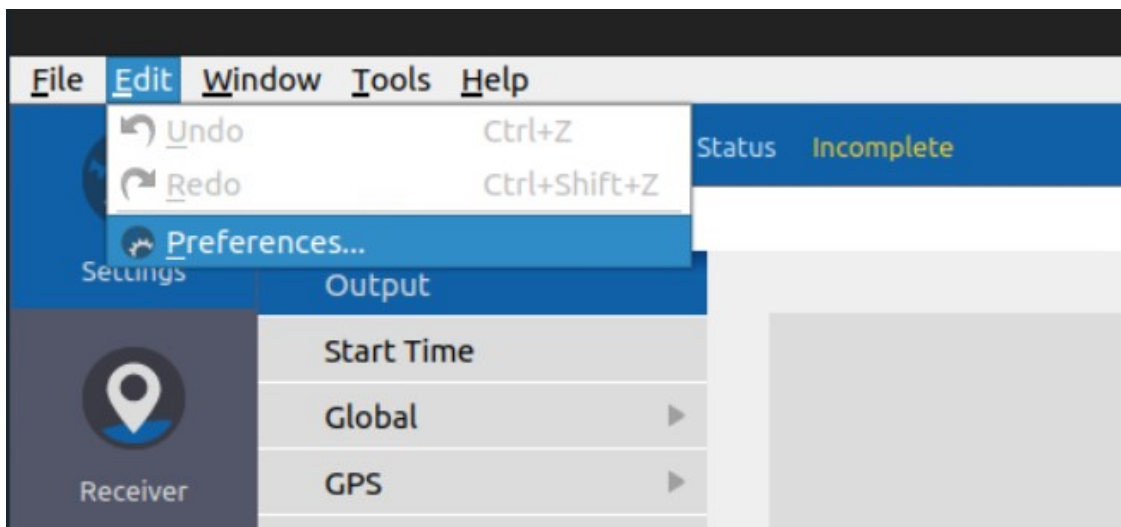

In the Preferences menu, click the CDM-7 tab.

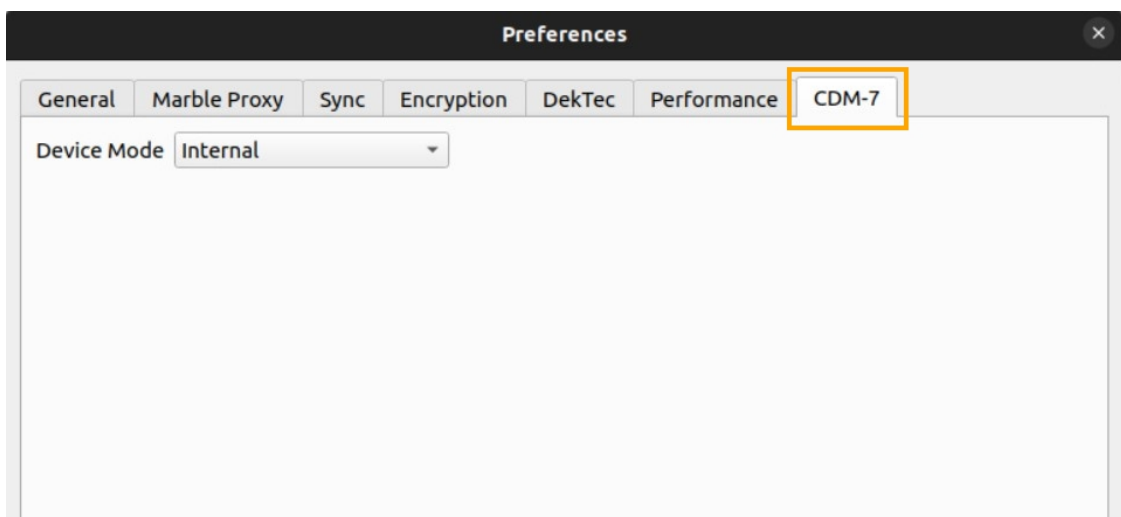

The CDM-7 mode can be changed using the Device Mode drop-down.

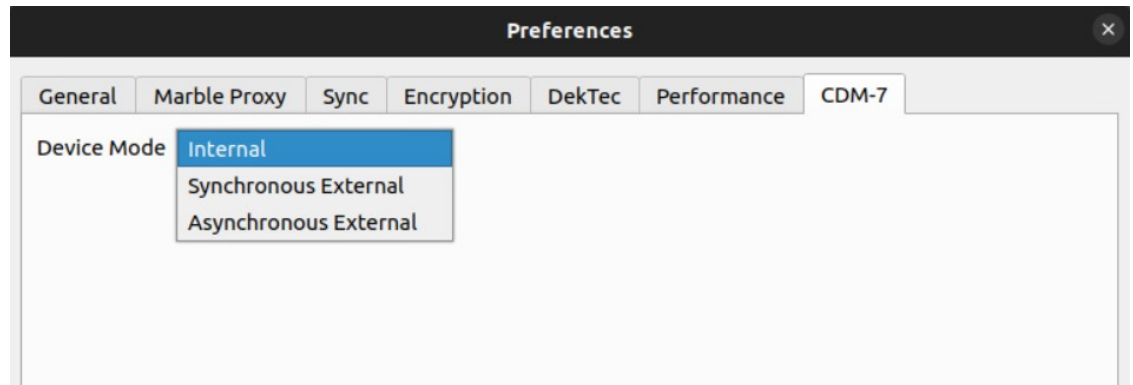

The next time a simulation is started in Skydel, the CDM-7 will use the newly selected mode.



Note: If multiple CDM-7 modules are connected, the selected clock mode will be applied to all modules.

3.5.8 Custom Constellation

You can change the custom constellation's Name and the Number of Satellites from the Custom Constellation tab. The Name must have between 1 and 10 characters, and can not be repeat any constellation names that already exist in Skydel. The accepted Number of Satellites is between 1 and 400.



Note: Please note that for the changes to apply, Skydel needs to be restarted. After the restart, the constellation Name will be propagated in the Skydel graphical interface and remote API, as will the number of satellites.

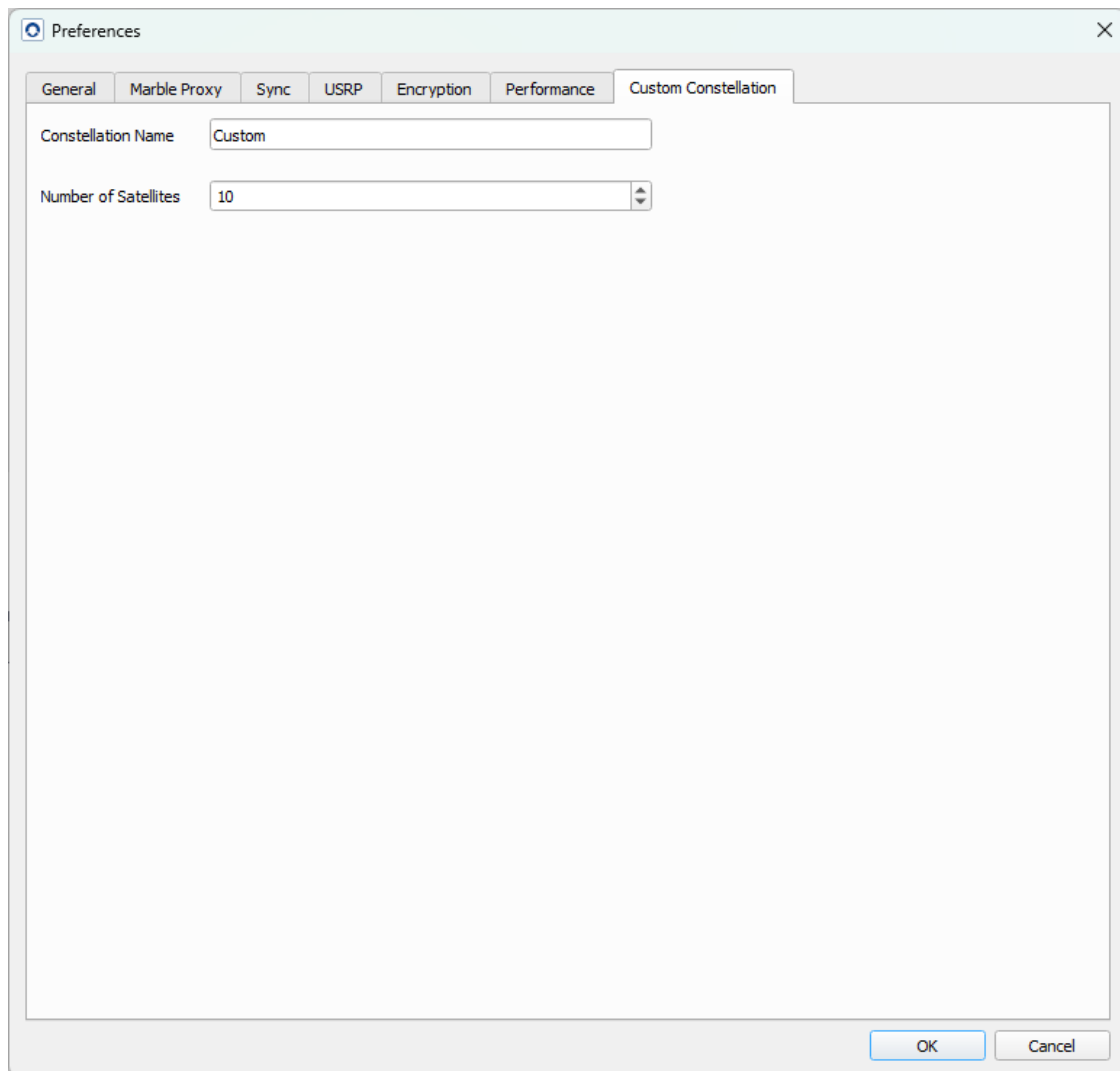

3.6 Configurations

To run simulations with Skydel you need to create, save, open, and modify “Configurations”. Sometimes configurations are called “scenarios”.

Configurations are just like any other type of computer file that is used to save or load. Use the File menu to access these options.

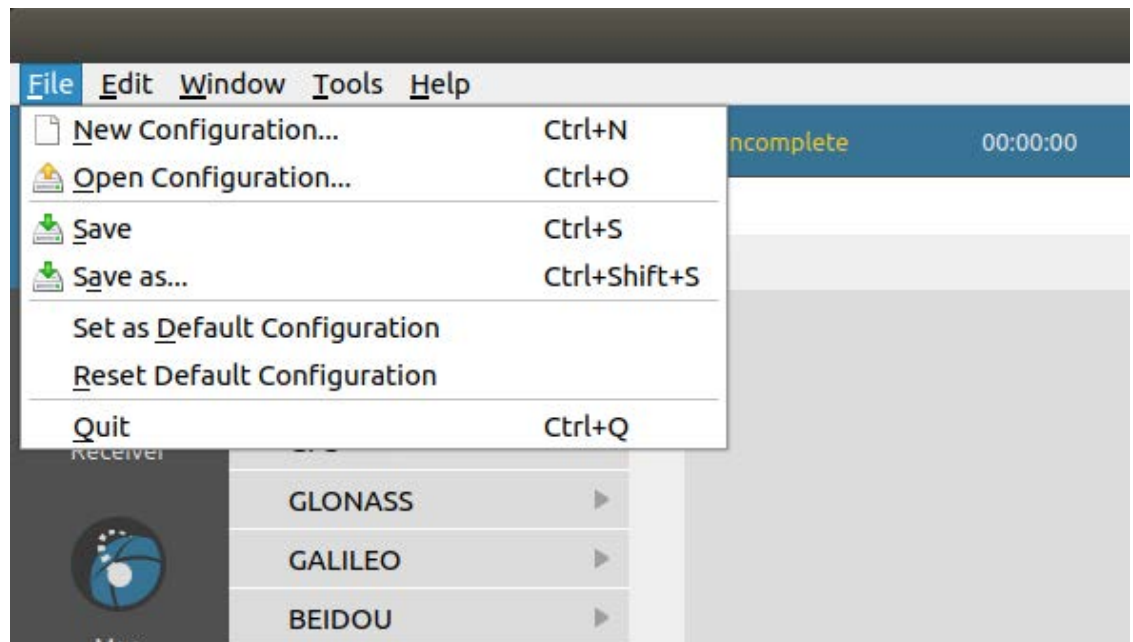

When you make changes to settings or interferences, the configuration will be marked as modified and Skydel will indicate Not Saved in the window's title bar. After saving the configuration, the indication will disappear until you make new changes.

3.6.1 Create New Configuration

To create a new configuration, click New Configuration in the File menu, or use the Ctrl+N shortcut. If the current configuration is modified (not saved), you will be prompted to discard or save it before creating a new configuration. If you cancel, the current configuration will remain and Skydel will not create a new configuration.

By default, a new configuration does not know anything about your hardware setup and you will first need to configure ["Settings: Output" on page 63](#).

3.6.2 Save Configuration

To save your current configuration, open the File menu and click Save or Save As.

By default, each of your configurations is saved in the Skydel-SDX/Configurations folder. Configuration files use the .sdx filename extension.

3.6.3 Open Configuration

To open an existing configuration, open the File menu and click Open Configuration. If the current configuration is modified (not saved), you will be

prompted to discard or save it before opening an existing configuration. If you choose to cancel, the current configuration will remain active and Skydel will not open the configuration.

3.6.4 Set as Default Configuration

Use this option to set the current configuration as the one to use when you ["Create New Configuration" on the previous page](#).

3.6.5 Reset Default Configuration

Use this option to reset the default configuration to the initial default configuration (factory reset). Clicking this option will not change your current configuration.

If enabled, it is possible to use Skydel in Configuration Mode.

Configuration Mode is used to prepare complex scenarios prior to using them on a simulator. This can be accomplished "offline" or on a laptop, for example.

In this mode, it is not possible to Start a simulation.

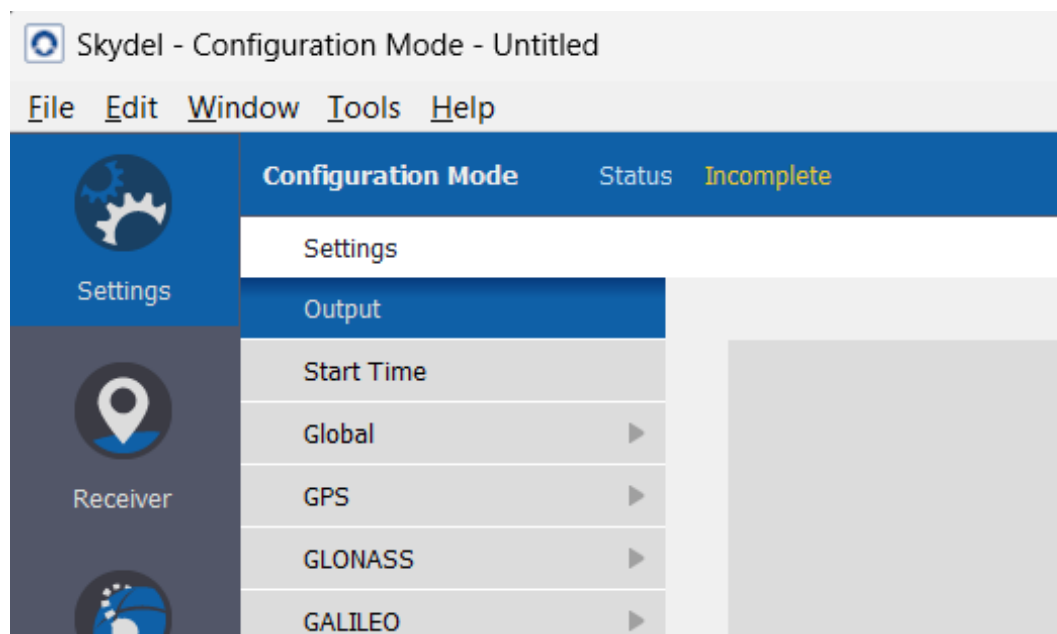

3.7 Running Your First Simulation

If you are new to Skydel, we recommend that you follow the instructions in this section to create your first configuration. This is a quick walk through of the steps

required to get a simple GPS simulation up and running. We will also highlight some interesting features along the way. Refer to the [Settings](#) section if you would like more details on a particular area.

3.7.1 Create a New Configuration

Click New Configuration in the File menu (or use Ctrl-N shortcut). If you already have a configuration loaded and modified, you will be prompted to save or discard it.



3.7.2 Add a radio

Next, you will need to add a radio. Navigate to **Settings - Output**.

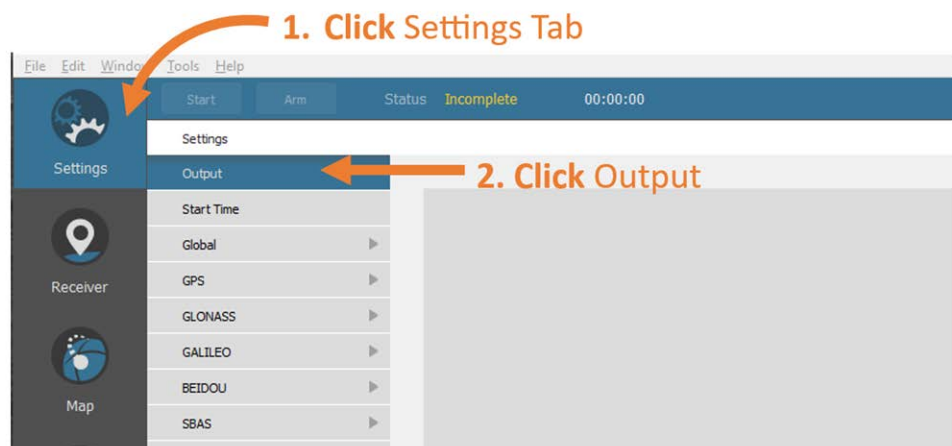

Note: A radio may already be enabled in your "Set as Default Configuration" on the previous page. If that is the case, you can click on the Clear button to remove all radios.

The DTA-2116 will be added with the default IP address and clock settings. If the default values are incorrect for your hardware setup, click Edit to make the necessary changes and click OK when done.



3.7.3 Select GNSS Signals

Click the Edit button for the RF A output of Radio 1.



Select GPS L1 C/A and click Ok.

Note: You can also select Gaussian Noise. This will reproduce realistic C/No.

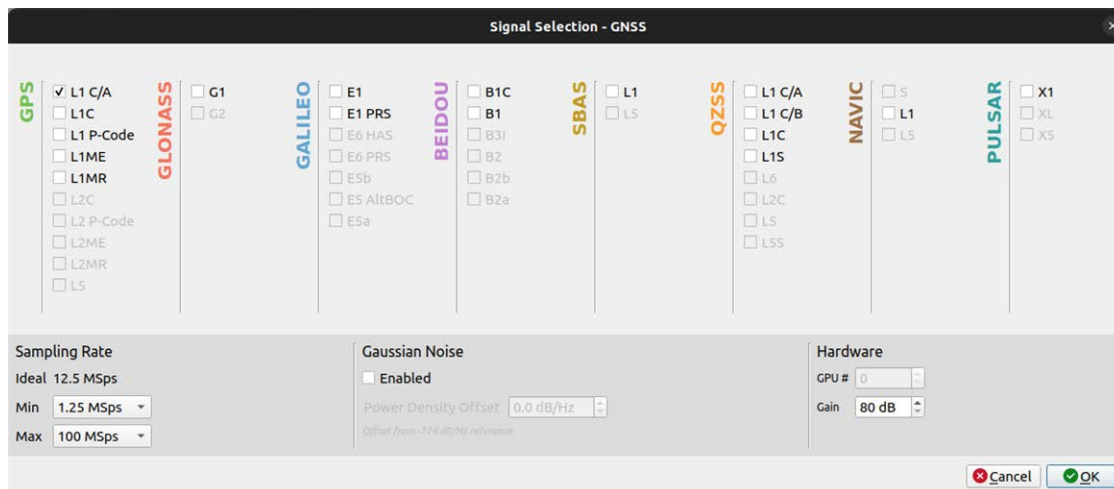

For more information about signal selection, refer to the ["Settings: Output"](#) on page 63 section. Or, you can also consult ["Additional Skydel Resources"](#) on page 57.

3.7.4 Select Vehicle Motion

Next, we will configure our vehicle to travel in a circle. Navigate to **Settings - Vehicle - Body** to change the vehicle motion settings.



Next, select Circular from the dropdown list to choose a circular trajectory. Other details, such as location, speed, and radius of the trajectory can be modified by hitting Edit.

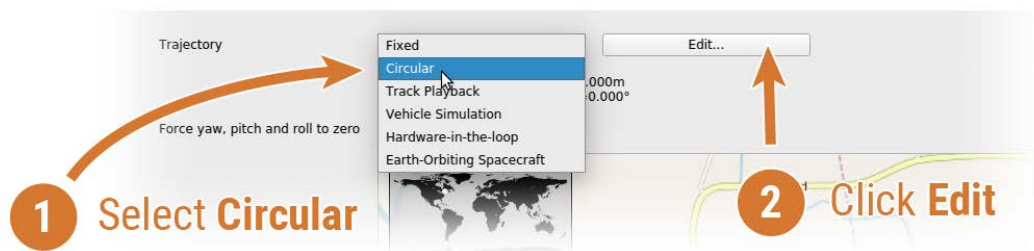

To navigate back to the **Settings**, click the back arrow.



3.7.5 Start the Simulation



Caution: Before you begin a simulation with a connected receiver, make sure that you attenuate the RF signal to a proper power level using RF attenuators. See section "[Reference Power Level](#)" on [page 69](#) for details.

To start the simulation, click the Start button. This action is only available when the status (see "[Simulator State](#)" on [page 26](#)) is Ready.

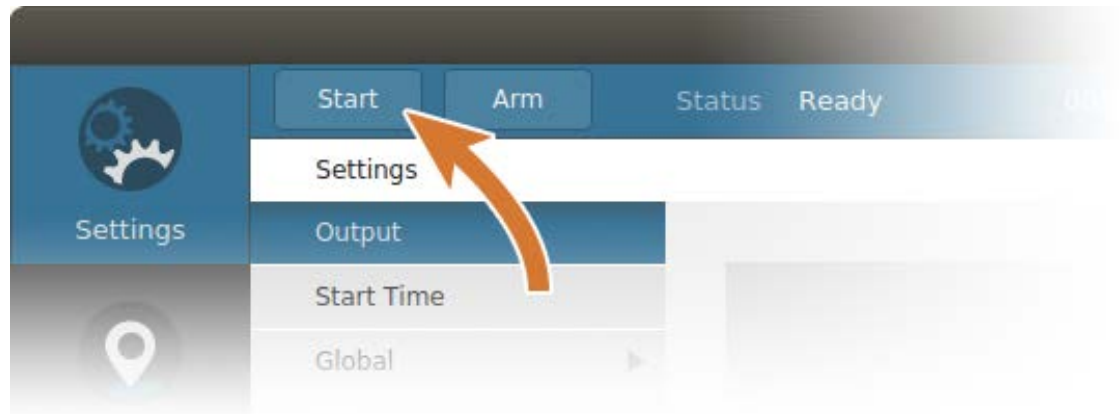

The simulator state will change to Initializing for approximately 10 seconds and if there are no issues with the plug-in instances initialization and the hardware setup, the state will then change to Streaming RF. Now the simulation is running.



During the simulation run (Streaming RF), you will see the elapsed time advance. The Stop button stops the simulator and RF streaming, while the Pause button will slow the vehicle to a halt while the simulator continues to stream RF. If you click on the Map tab, you will see the vehicle is not moving when you click Pause, and starts moving again when you click Resume.



If your GNSS receiver is streaming NMEA to a serial or USB port, you may connect to your receiver (see "[Receiver](#)" on page 205) to parse and analyze the NMEA data in real-time.



Resources: Learn How To Use Skydel: The Skydel Certification Courses expose learners to new concepts and hands-on experiences. These free, self-paced GNSS Simulation Courses are designed to prepare you for Skydel Certification and other industry-recognized certification exams. These online courses provide the following:

Coursework: Engaging learning experiences with interactive content such as practice quizzes, extra learning materials, videos, and instructions on how to run the software on your own to follow along in the certification courses.

Community: Once registered, you will have access to the Skydel Community Forum. You can ask questions with other students and/or peers as well as interact with instructors.

Proof of Completion: You will receive a shareable .pdf certificate of completion. You will have the ability to share a link with anyone, put it on your resume or integrate into your LinkedIn profile in the Certifications section.

[Register for Skydel Certification Courses here](#)↗

3.7.6 Additional Skydel Resources

Here is a list of additional resources, articles, and application notes that can help you maximize Skydel's potential in your GNSS simulation:

- » [Configure Satellite Positions Based on User-defined Elevation/Azimuth](#)↗
- » [Creating "Fixed" GNSS Satellites](#)↗
- » [Creating Custom Signals](#)↗
- » [Creating and Simulating LEO Constellations](#)↗
- » [Measuring a GNSS Signal and Gaussian Noise Power](#)↗
- » [Register for Skydel Certification Courses here](#)↗

3.8 Settings: Overview

When creating and modifying configurations, you will spend the majority of your time in the Settings tab of Skydel. You can access the Settings tab by clicking this button:

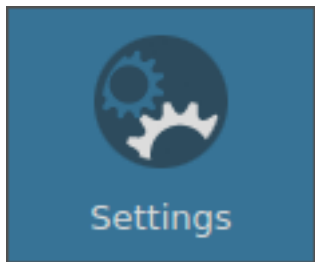

Remember that settings are stored in your [Configurations](#). After making changes to settings, you might want to save them for future use.

You can see the settings tab in the image below.

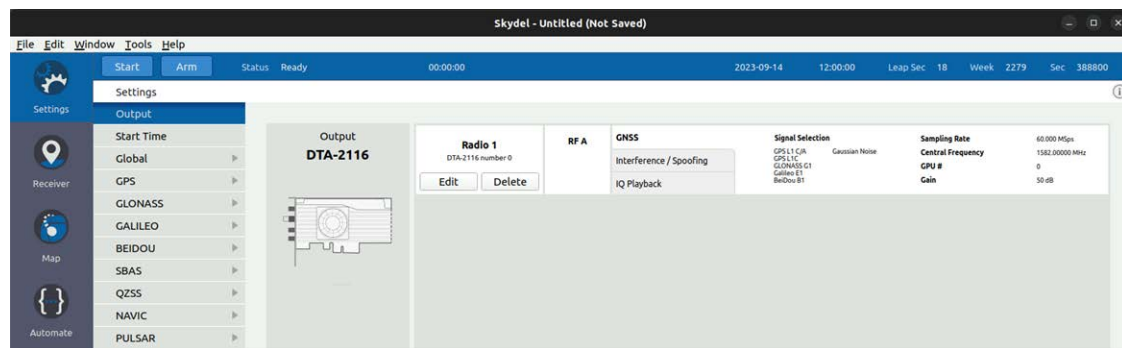
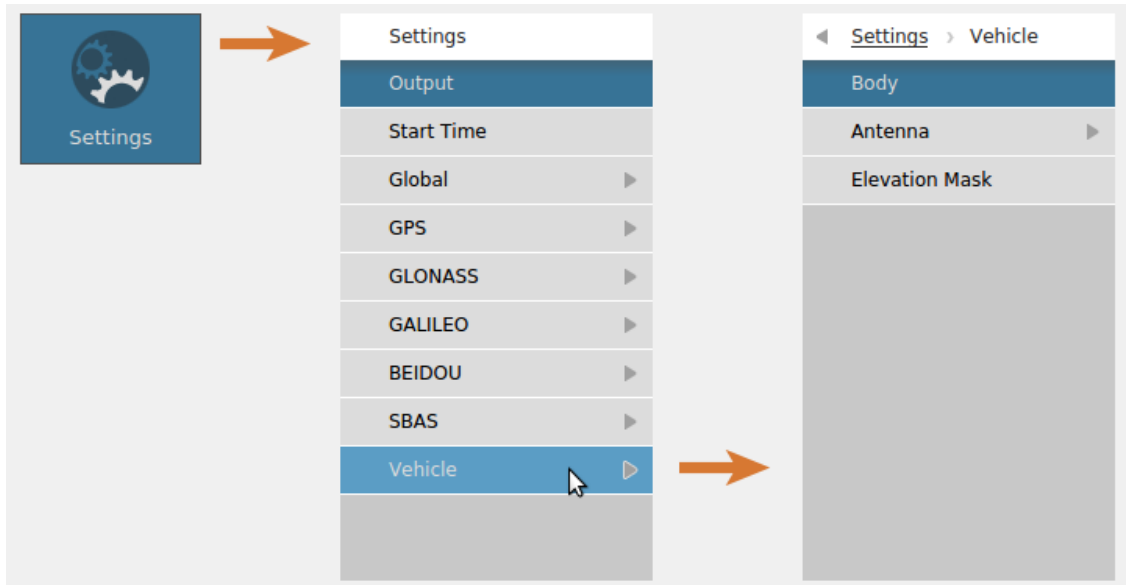

Figure 3-13: Settings Tab

The settings are divided into several categories. Depending on your [license](#), the settings menu may show different categories.

To navigate to a specific category, first click the Settings button. Then click on the appropriate settings menu and sub-menu. In this document, we will refer to these sorts of steps by instructing you to navigate **Settings - Vehicle - Body** (or something similar).



As you navigate in the Settings, a visible path builds itself at the top of the menu. To leave a nested settings category, click the back arrow.

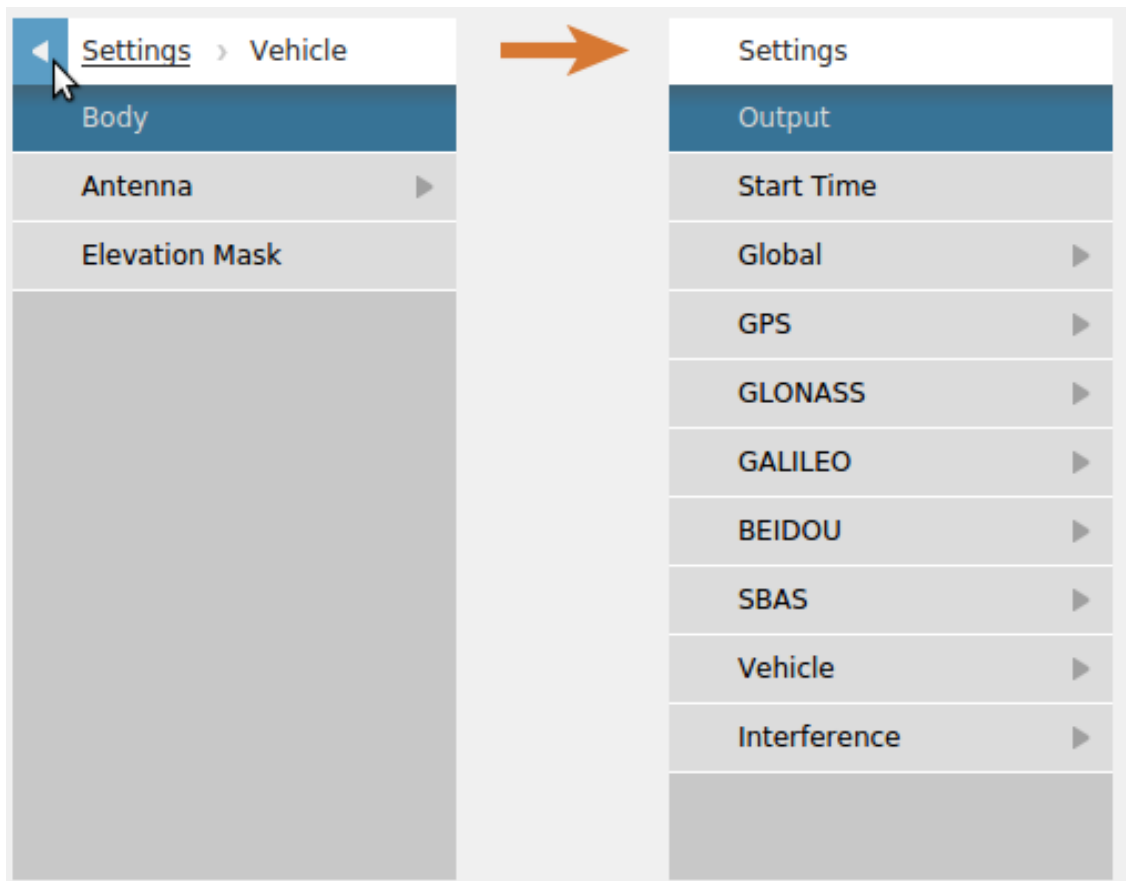

Alternatively, clicking the parent category (underlined) in the path will move you back one level.

At the bottom of the settings tab, you can see the sky view and the power sliders. You can click & drag the horizontal splitter up and down to adjust the sky view's dimensions. In the sky view, you can uncheck Show All Systems to display only a single type of constellation at a time. The buttons on the left are called the Constellation Selectors and they let you choose which constellation is shown in the sky view and referenced in the power sliders.

The image below shows the GPS constellation only.

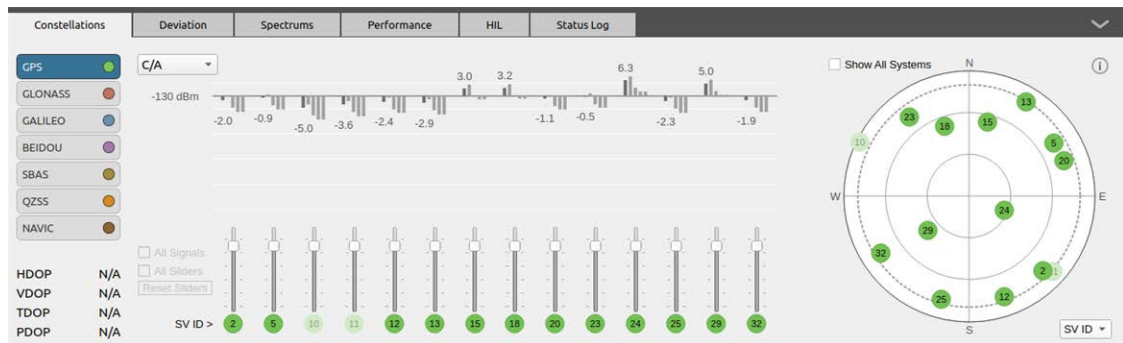

Figure 3-14: GPS Constellation

The image below shows the GLONASS constellation only.

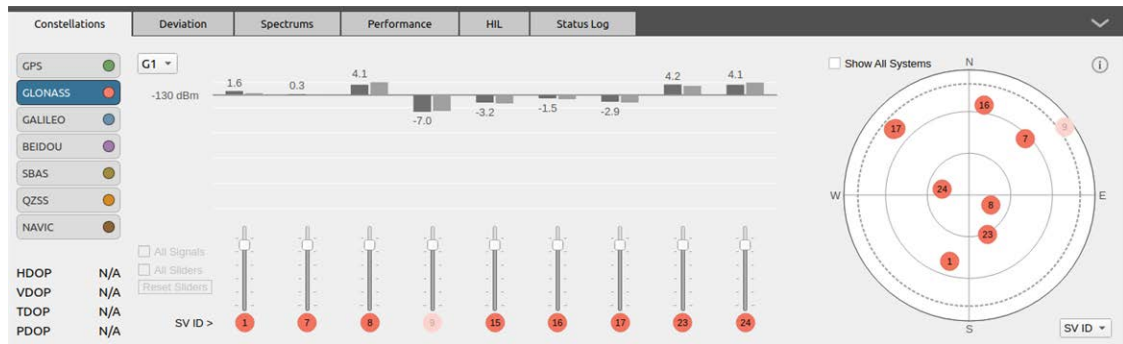
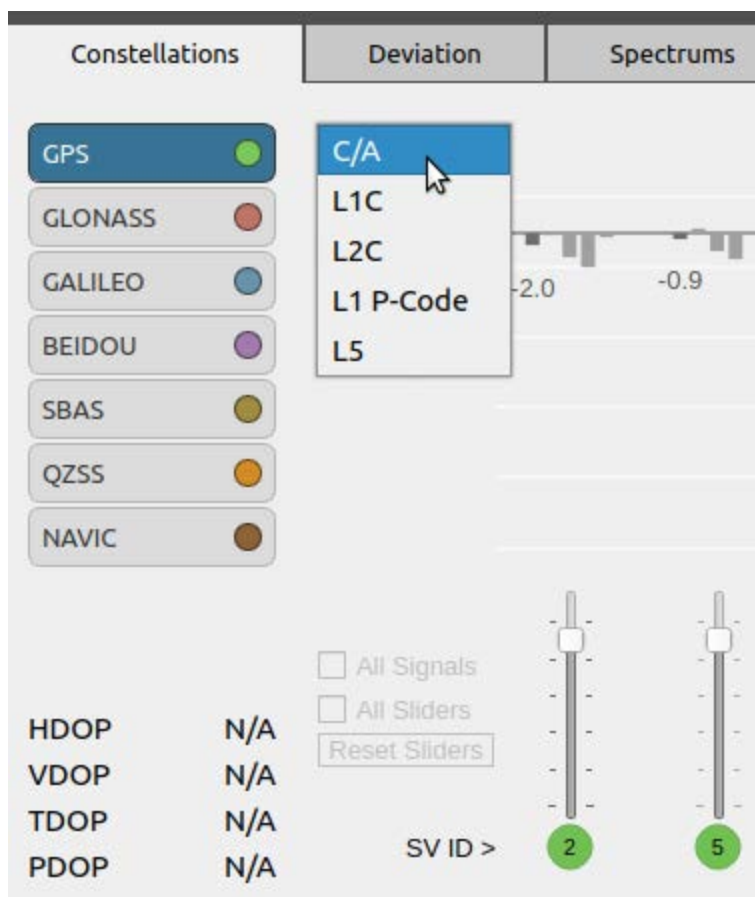

Figure 3-15: GLONASS Constellation

You can change the user interface selected signal using the combo box.



The selected signal affects different parts of the user interface:

- » The sliders only change the selected signal, unless the check box "All signals" is selected
- » The power label over or under the power bars is only for the selected signal
- » The satellite power info button opens the dialog for the selected signal

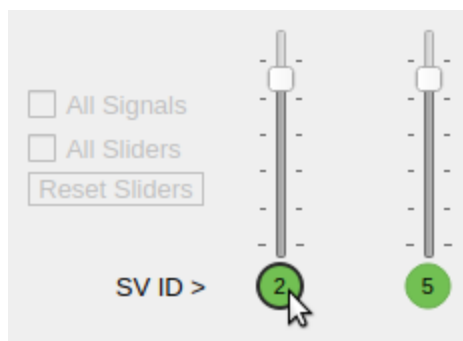

Signal Power (C/A)
×

Nominal Power	-130.0 dBm
Signal Strength Model	-0.9 dB
Antenna	-4.1 dB
Global Offset	0.0 dB
Signal Offset	3.0 dB
Manual Offset	<input style="width: 50px;" type="text" value="0.0"/> dB
<div style="display: flex; justify-content: space-between;"> Total -132.0 dBm </div>	

Once the simulation is started or armed, the sliders are enabled as well as the Manual Offset combo box in the power info dialog.

If you place your mouse over a satellite in the sky view, you will see additional information about that particular satellite, such as its elevation and azimuth relative to your receiver.



Note: The sky view does not change as a result of vehicle attitude (yaw, pitch and roll) changes.



Note: The DOP values do not change when you select one constellation in particular. The DOP values always include all satellites from all constellations.

In the upper right corner of the sky view, there is a round button with the letter ‘i’ in it. This button brings up a window with additional information about the sky view.

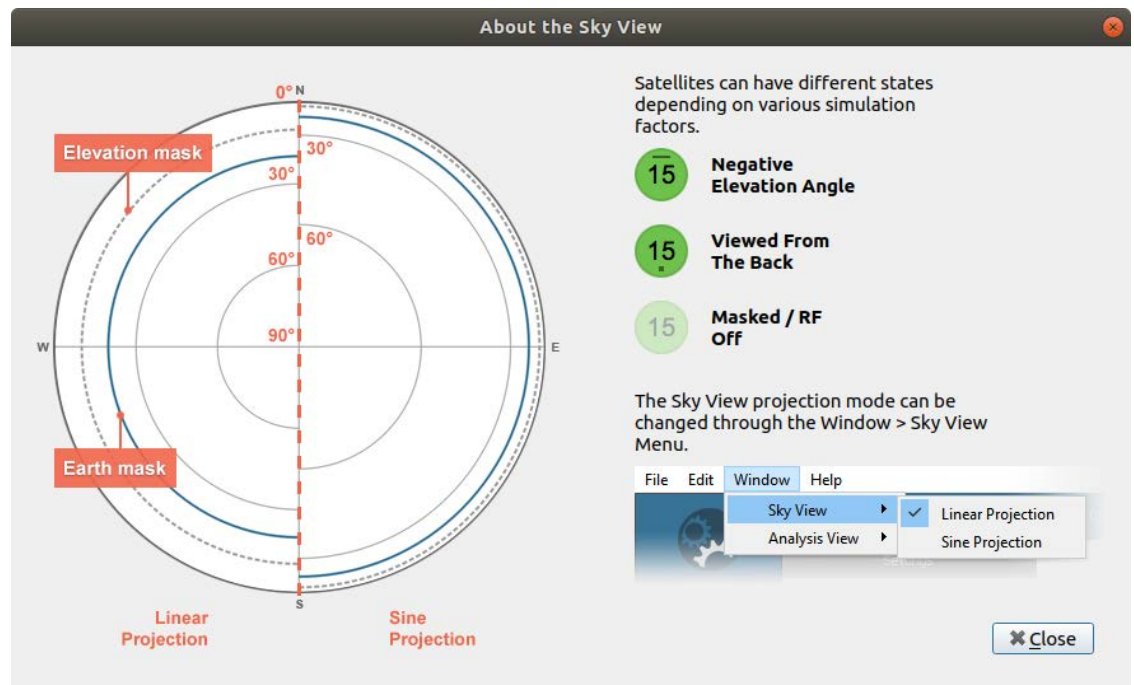

Figure 3-16: Sky View Information

3.9 Settings: Output

This Settings: Output section contains the following subsections: ["Radio Selection"](#) on the next page, ["Signal Selection"](#) on page 65, ["Reference Power Level"](#) on page 69, ["Optimizing Performance"](#) on page 70, ["IQ Data Files"](#) on page 72.

The Output settings are located in the **Settings - Output** menu.

The Output settings are where you control which RF output will generate which signals. These settings are what bridge the gap between the software simulation and the hardware signal generation. Proper setup of the output settings is a key component of a successful simulation.

You start by selecting the output type for the simulation. The options are:

- » DTA-2116: Software-defined radio from DekTec.
- » File: The IQ data will be saved to a file on the computer's hard drive.
- » N310: Software-defined radio from Ettus Research.
- » None: RF is not generated and IQ is not saved, raw logging data is saved.
- » NoneRT: Similar to None but runs in Real Time. Useful when developing automation scripts (see ["Automate"](#) on page 210).

- » X300: Software-defined radio from Ettus Research. Equivalent radios from National Instruments can be used as long as they have the correct firmware (see [Firmware: Ettus X300/X310; NI USRP-294xR/295xR](#)). If you have a X310 radio, select X300 in the list.

 **Note:** For the remainder of this section, we will be using the X300 SDR output type as an example. GSG-7 and GSG-8 users will see a DTA-2115b or DTA-2116. Setting up the other output types is very similar.

 **Caution:** The "RF" license is required to generate signals on a RF output. If the RF license is not activated on the system, it is only allowed to start the simulation when using either the None or NonRT output types.

3.9.1 Radio Selection

In the **Settings - Output**, select the X300 SDR in the dropdown list and click Add.

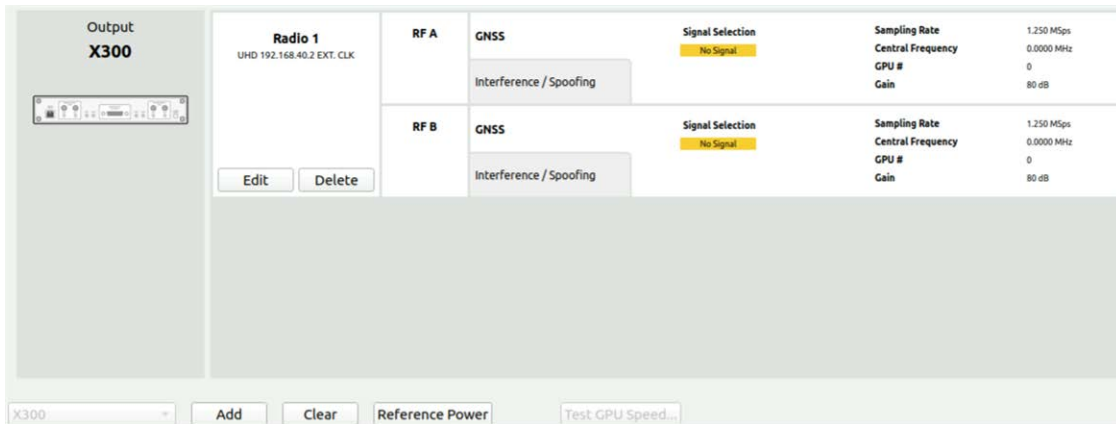

 **Note:** If an output is already added, you can click on the Clear button before adding the X300 SDR. You can add multiple outputs, but they must be of the same type. For example, you can add 2 USRP X300 radios, but you can't add a DTA-2116 after you have added a X300.

When adding a USRP radio such as the X300, the IP address and clock source are preset with default values as defined in the [Preferences](#). If the default values are incorrect for your setup, click Edit under the radio name to edit the radio settings.



Note: Changing the values here will not change the preferences.

3.9.2 Signal Selection

Take a moment to look at the front of the USRP X300 radio. You will notice that it has an RF A TX port and an RF B TX port.



The markings on the radio correspond to the labels in the Output settings. For example, any signals assigned to RF A in the Output settings will be generated and output by the USRP X300 RF A TX port. To assign GNSS signals, select the "GNSS" option for the corresponding output.

The Interference / Spoofing option is only displayed for users with Advanced Jamming or Spoofing Licenses.

Output	Radio 1	RF A	Signal Selection	Sampling Rate	
X300 	Radio 1 UHD 192.168.40.2 EXT. CLK [Edit] [Delete]	GNSS	No Signal	1.250 MSps	
		Interference / Spoofing		0.0000 MHz	
				GPU #	0
				Gain	80 dB
		RF B	GNSS	1.250 MSps	
			Interference / Spoofing	0.0000 MHz	
				GPU #	0
				Gain	80 dB

The Signal Selection dialog box will help you choose the signals that you want to be generated for each output.

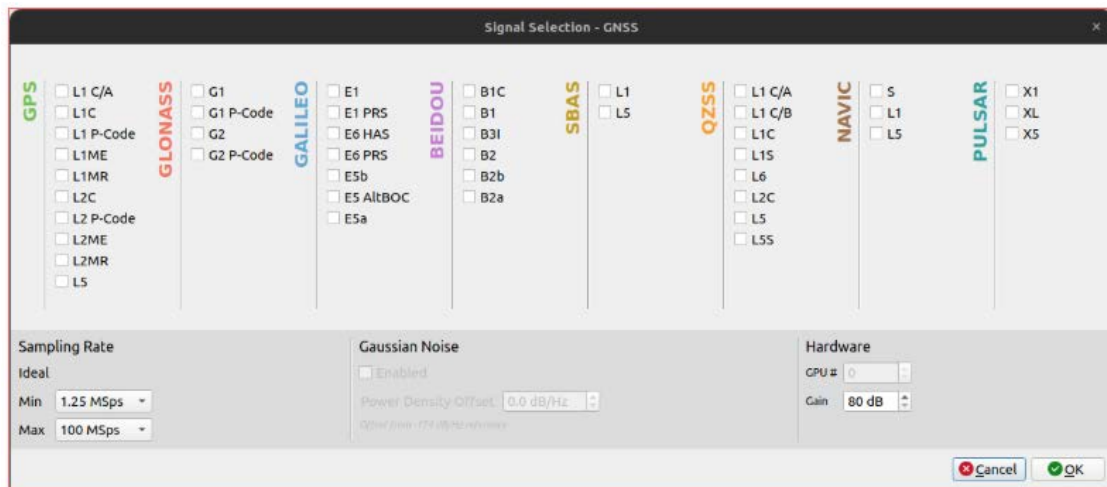

If the Gaussian Noise option is selected, Skydel will introduce noise to simulate realistic Carrier-to-Noise ratios (C/N₀). The power level of this added noise can be adjusted through the power density offset parameter. This offset adjusts the noise in relation to a reference value of -174 dB/Hz. This reference is based on a C/N₀ value of 44 dB/Hz, assuming an ambient temperature of 20°C.

By default, the seed used for the pseudorandom number generator responsible for the generation of the added Gaussian Noise signal is automatically set by Skydel. If you wish the added Gaussian Noise signal to be deterministic across simulations, you can use the `SetGaussianNoiseSeed` remote API command to override the default seed value set by Skydel.

Next, select the signals that you would like this output to generate. As you make selections, you will notice that the dialog box will update the Ideal Sampling Rate as well as disable code types that are not compatible with your current selection. For example, when selecting Galileo E5 AltBOC in the lower L-band, the current sampling rate changes to 60 MSps (Mega Samples per second). Some signals are disabled because they are too far away from the E5 signals to fit within the same RF band. To manage this, you can either choose a radio that can support higher sampling rate or use an additional output (or additional radio).

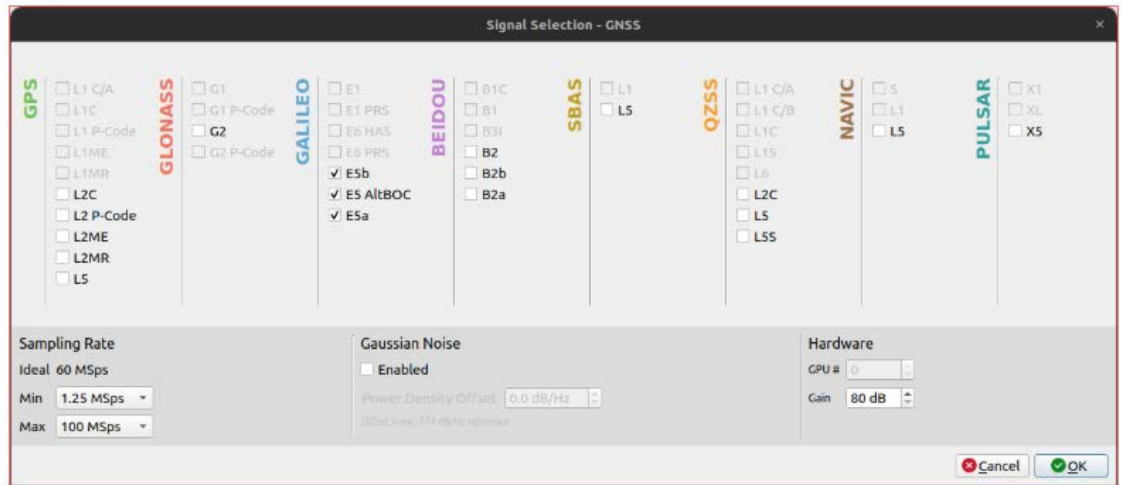

You may constrain this output to keep its sample rate low by changing the Max Sample Rate to a lower value. Alternatively, you may constrain the output to remain high by changing the Min Sample Rate to a higher value.

Due to a limitation in the hardware, some SDR models require that all outputs must have the same sampling rate. For example, if the signals selection on RF A requires 25 MSps and the signals selection on RF B requires 12.5 MSps, both outputs will be set to 25 MSps. For SDR models with this constraint, the selected sampling rate is always the highest sampling rate of any available output.



Note: Only signals for which you have an active [license](#) will be available for selection.

For example, Galileo E5 AltBOC can be generated if you have an active Galileo E5 license by clicking E5 AltBOC or both E5a and E5b under Signal.

The default gain for the USRP X300 radio is **80 dB**. You can change the gain by 1 dB step between 80 dB and 145 dB. See the "[Reference Power Level](#)" on page 69 section below for more details.

Once you have made your signal selection, click the "OK" button to return to the Output settings.



Note: The simulation will not run if you try to assign the same signal to multiple outputs.

Once you have completed your signal selection for all outputs, the Output settings should look something like this.

Output X300 	Radio 1 UHD 192.168.40.2 EXT. CLK Edit Delete	RF A	GNSS Interference / Spoofing	Signal Selection GPS L1 C/A Gaussian Noise	Sampling Rate 25.000 MSps Central Frequency 1575.4200 MHz GPU # 0 Gain 145 dB
			RF B	GNSS Interference / Spoofing	Signal Selection GPS L2C GPS L2 P-Code Gaussian Noise

Note: Adding radios and selecting signals can be a repetitive task. You can save the current output settings as the default outputs by using "Set as Default Configuration" on page 50.

IQ Playback

The IQ Playback option allows the playback of a waveform stored in a binary file containing the IQ data of the waveform.

If the IQ Playback License is enabled, the "IQ Playback" option is selectable:

Output X300 	Radio 1 UHD 192.168.40.2 EXT. CLK Edit Delete	RF A	GNSS Interference / Spoofing	IQ File GPS_L1CA.iq	Sampling Rate 12.500 MSps Central Frequency 1575.42000 MHz GPU # 0 Gain 80 dB
			RF B	GNSS Interference / Spoofing	IQ File jammer.iq

Note: Note: this option is not available for the following Targets: None, Wavefront and Spoofer.

When the IQ Playback option is clicked, you will be prompted to select an IQ File for playback. Once a valid IQ File is selected, the IQ Playback configuration dialog box will open, allowing you to customize the IQ Playback output:

Signal Selection - IQ Playback

IQ File Path Change Path...

Gain

GPU #

Here is a description of the different parameters:

- » The "IQ File Path" field represent the path of the playback IQ File on your PC. Press the "Change Path..." button to browse for the file.
- » The "Gain" field allows you to change the gain of the output. See the section "[Reference Power Level](#)" below.
- » The "GPU" field allows you to specify which GPU on your system is used to process the data for this output. This field is grayed out if your system only has a single GPU.

The waveform stored in the IQ File must be a baseband IQ-Complex waveform. The format of the file is described in the "[IQ Files](#)" on page 299 appendix.



Caution: The waveform can have a lower sample rate than the RF output where it will be injected. If so, the waveform selected will be upsampled in real-time during the simulation.

3.9.3 Reference Power Level

Once you have selected a radio, you can click the Reference Power button to get the nominal power at the TX connector.

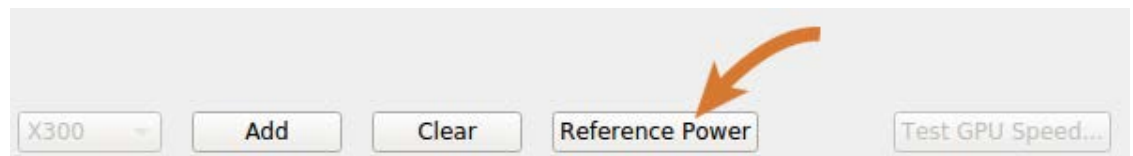

For the X300, the reference power level is -50 dBm at the TX connector for a single GPS L1C/A signal.

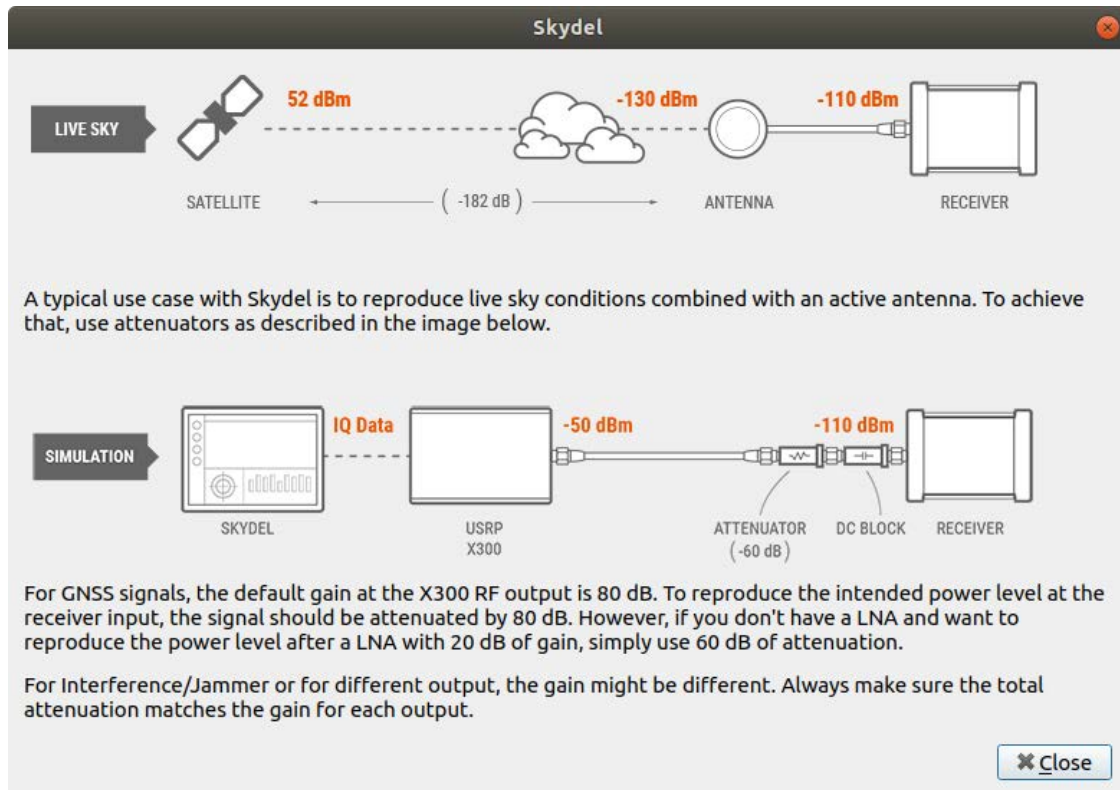

3.9.4 Optimizing Performance

The main concern when configuring the Output settings is staying within the performance limitations of both the CPU and the GPU. Skydel is a software-defined GNSS simulator, so the number of signals (GNSS or Interference) that can be simulated is limited by the performance of the software running on the computer (most simulators are limited by the amount of hardware channels they have). The number of signals that can be simulated depends on a number of factors:

- » the number of signals being generated (e.g., $[C/A + P] \times 10$ satellites = 20 signals);
- » the sampling rate of those signals (e.g., 50 MSps, 12.5 MSps);
- » the complexity of those signals (some signals are harder to simulate than others).

If you hit the performance limit of your computer, you have 2 options. Option 1 is to reduce any of the items listed above. Option 2 is to increase the performance of the hardware.

When you select signals with different carrier frequencies, Skydel must increase the sample rate to cover both signals and use a carrier frequency in-between the 2 signals. However, if you assign these signals to different RF outputs (RF A vs RF

B), Skydel will reduce the sampling rate. This will greatly reduce the workload for the GPU.



Note: You can disable the spectrum subtab in the preferences to reduce the CPU/GPU workload.

Once you have completed the signal selection, you can test the performance of the GPU by clicking the Test GPU Speed button. The GPU Benchmark dialog box will display the signals that you have selected in the Output settings. Signal types that you have not selected will not be part of the test. The benchmark assumes 14 satellites for GPS and 10 satellites for each of the other constellations. If you only expect 10 GPS satellites to be in view, you can lower this value to more accurately reflect the conditions you will observe during your simulation.

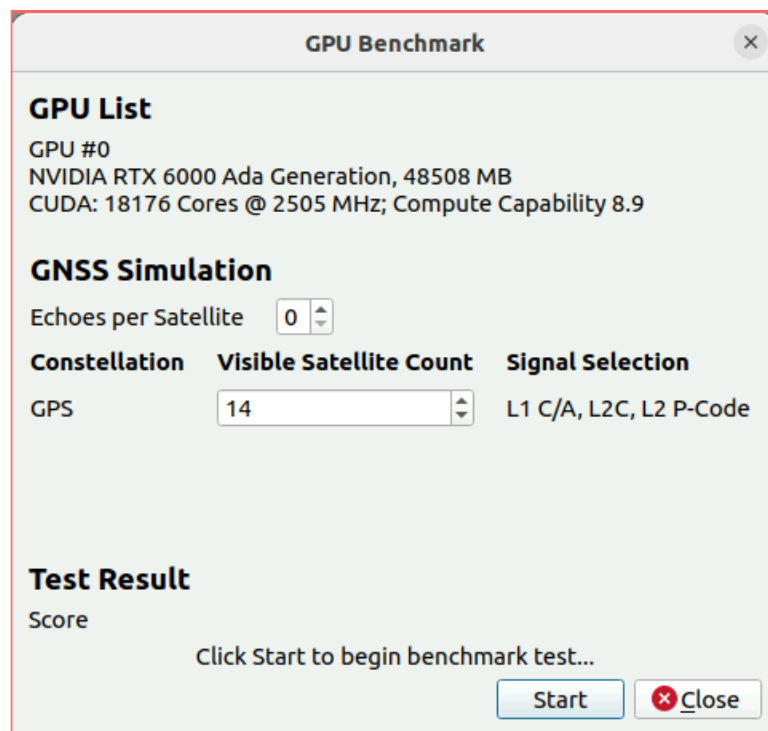

Once you are satisfied with your selection, click the Start button to begin the test. Once the test has completed, you will see a score for the GPU. A score higher than 1.00 means the GPU performance is sufficient for this signal selection. However, you don't want to cut it too close, we recommend a score of 1.10 or higher. A score of less than 1.00 means the GPU doesn't have enough performance to generate the signals in real time. Try reconfiguring the Output settings to use smaller sample rates, reducing the number of satellites, or reducing the number of signals selected.

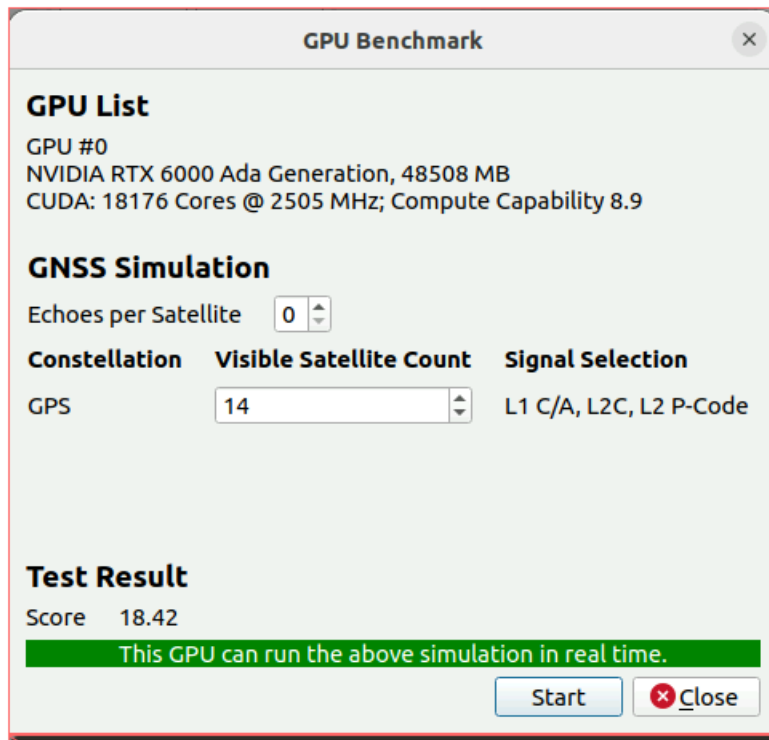

3.9.5 IQ Data Files

To save IQ data to a file, select “File” as the output type and click the “Add” button. (If you already have another output type configured, you will have to delete each of them before proceeding).

Skydel will prompt you to name the file that you would like to save the IQ data to. You should consider saving this data on a hard drive with plenty of space and fast writing speed because IQ data files can grow very large over time. You can add multiple IQ data files by clicking the “Add” button. This step is necessary if you want to save both L1 and L2 data. Add signals to each individual IQ file using the “[Signal Selection](#)” on [page 65](#) dialog box that is used for X300 SDRs. Once you have selected each of the desired signals, your output settings should look something like this:

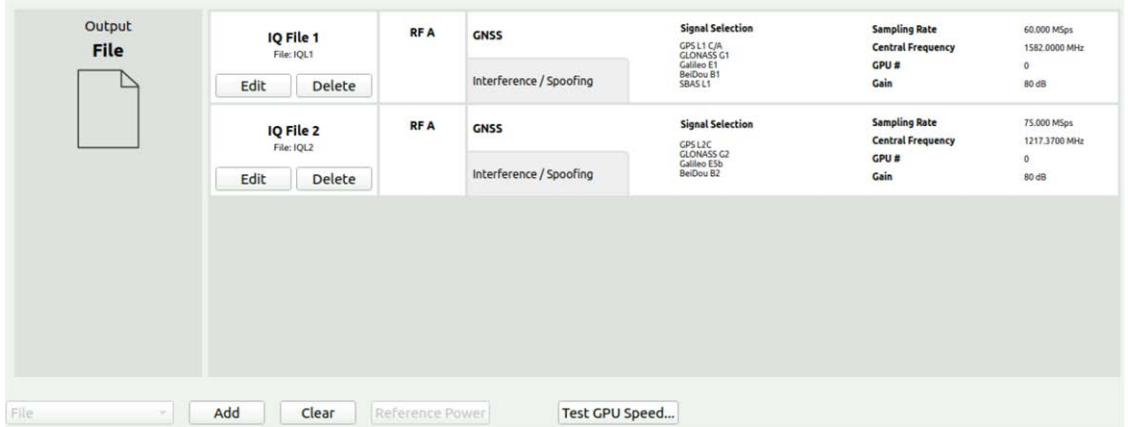

When you are ready, start the simulation. Skydel will begin saving data into the specified files.

 **Note:** IQ files can be very large. You will quickly fill up your hard drive if you let the simulation run for too long.

When saving data to IQ Files, your GPU does not need to pass the performance test. Skydel will generate the file as fast as it is able, which, depending upon the performance of your GPU and your hard drive, may be slower or faster than real-time.

When you generate an IQ file with Skydel, you get 2 files per RF output:

- » IQ File Data
- » IQ File Metadata

Both of these file formats are described in the ["IQ Files" on page 299](#) appendix.

 **Note:** Note:It is normal to have zeros at the beginning of the file. When the simulation starts, the simulator will start the simulation of the transmission of the signals from the GNSS satellite, but since it takes several milliseconds to reach the receiver antenna, the file will be filled with zeros or Gaussian noise until the signals reach the receiver. Typically, that delay is around 70msec depending on the distance of the satellites with the receiver.

3.10 Settings: Start Time

The Start Time settings are located in the **Settings - Start Time** menu.

The Settings: Start Time subsections include: ["Custom Time" on the facing page](#), ["Current Computer Time" on page 76](#), ["NTP Server Time" on page 76](#), ["GPS Timing Receiver Time" on page 77](#), ["Leap Seconds" on page 77](#), and ["Duration " on page 78](#).

Controlling the simulation start time is one of the key considerations when testing GNSS receivers. To compare different test runs, it is often critical to have the same start time values to ensure that the GNSS satellites' geometry is identical for each run.

Some GNSS receivers will refuse to lock on the simulated signal if their internal clocks cause them to believe the time is incorrect. This is one of the many ways a receiver can protect itself against spoofing. It is sometimes necessary to reset the receiver before each simulation to work around this defense mechanism.

It is not necessary to download a RINEX navigation message file matching the simulation start time. Skydel is capable of extrapolating in both the future and the past.

If you want to use a specific RINEX navigation message file as your ephemeris and almanac for the simulation, you will need to import the RINEX navigation file for each constellation (see ["General" on page 106](#)).

There are four ways you can control the start time of the simulation:

- » specify a custom time;
- » use the computer system time;
- » use the time from an NTP server;
- » use the time from a timing receiver.

When selecting the timing option to use, a preview will be shown to the right.

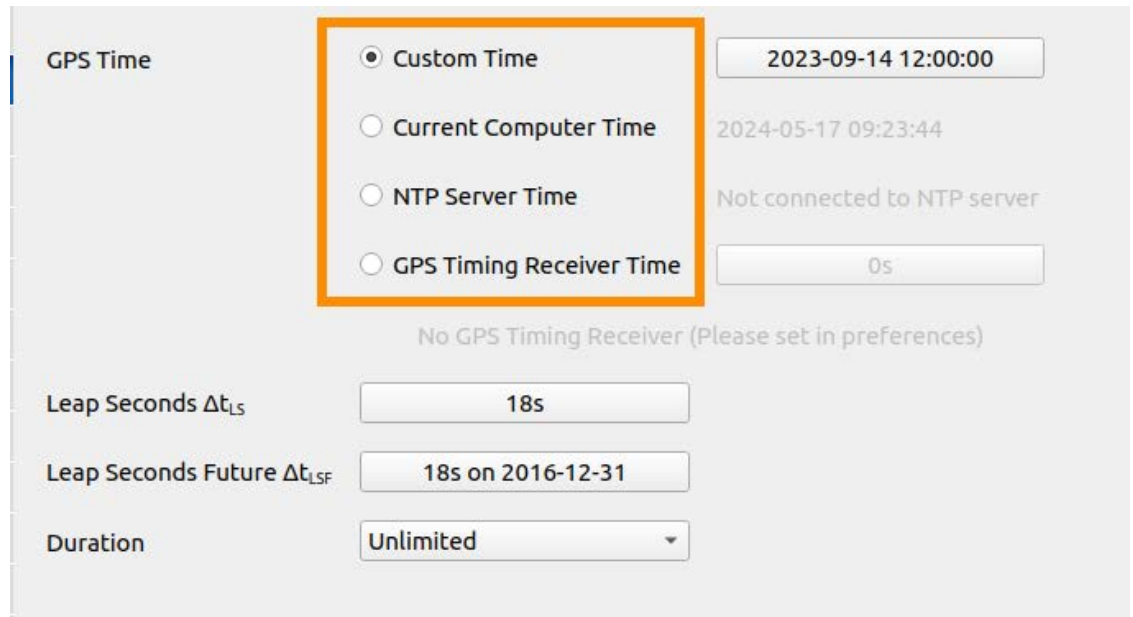

GPS Time

- Custom Time 2023-09-14 12:00:00
- Current Computer Time 2024-05-17 09:23:44
- NTP Server Time Not connected to NTP server
- GPS Timing Receiver Time 0s

No GPS Timing Receiver (Please set in preferences)

Leap Seconds Δt_{LS} 18s

Leap Seconds Future Δt_{LSF} 18s on 2016-12-31

Duration Unlimited

3.10.0.1 Custom Time

Setting a Custom Time is the most common method of controlling the start time of the simulation. Every time you run the simulation, it will start at the same time. You can change the custom time by clicking on the time field itself.

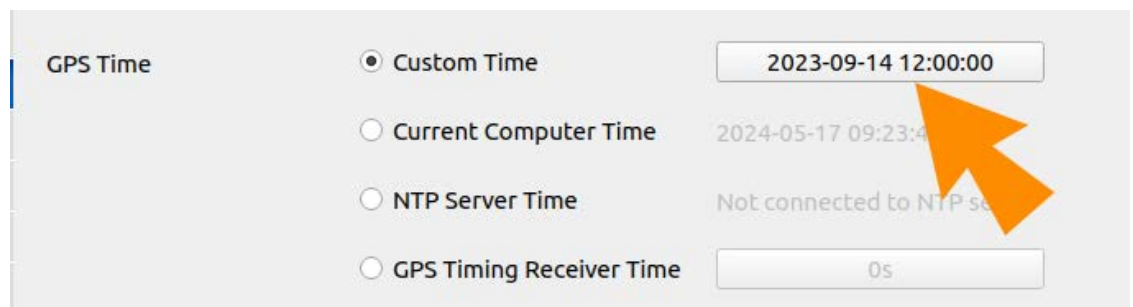

GPS Time

- Custom Time 2023-09-14 12:00:00
- Current Computer Time 2024-05-17 09:23:44
- NTP Server Time Not connected to NTP server
- GPS Timing Receiver Time 0s

You can specify the time with any of the fields provided. The other fields will update to reflect the changes that you have made. For example, you can set the date and time to 7/1/2016 and 07:00:00. The week and second will automatically be updated to 1903 and 457200.

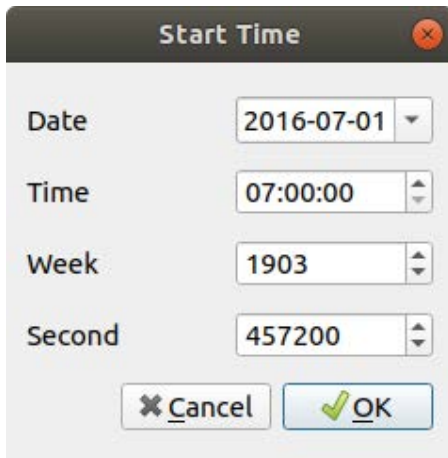

The image shows a dialog box titled "Start Time" with a close button (X) in the top right corner. It contains four input fields: "Date" with a dropdown menu showing "2016-07-01", "Time" with a spinner showing "07:00:00", "Week" with a spinner showing "1903", and "Second" with a spinner showing "457200". At the bottom, there are two buttons: "Cancel" with a red X icon and "OK" with a green checkmark icon.

3.10.0.2 Current Computer Time

If you select Current Computer Time, your simulation will be synchronized to the computer system time to within approximately 10 seconds. This is due to the time it takes to start the streaming process with the radios. Synchronizing in this way can be useful if you want your simulation to be close to true time. However, for tight synchronization with a time reference, it is necessary to use a timing receiver.

3.10.0.3 NTP Server Time

Synchronizing your simulation with an NTP server ensures precise temporal accuracy, crucial for maintaining the integrity and realism of time-dependent processes within a GNSS simulation. This synchronization reduces errors stemming from time discrepancies, enhancing the reliability and consistency of simulated outcomes.

For a reliable method to determine the start time of a time-synchronized simulation, select NTP Server Time.

The NTP server is configurable from the Preferences/Sync window, in the " [NTP Server](#)" on page 39 section.



Note: This feature is only enabled with the SKY-SYNRT (Synchronization with real time) license.

 **Caution:** As indicated in the " Simulator State" on page 26 section, it is important to know that when using an NTP Server, any changes made to the settings while the simulator is in the "Armed state" will be discarded when the simulation starts.

3.10.0.4 GPS Timing Receiver Time

If you want to synchronize your simulation with more accuracy, you can select GPS Timing Receiver Time. Ensure that your "GPS Timing Receiver" on page 38 preference is set correctly. Once everything is configured correctly, you will be able to see a preview of the start time.

Skydel will communicate with the timing receiver during the initialization process and ensure that the simulation starts at the specified time. This process happens after the radio initialization, so a precise synchronization can be achieved.

If desirable, you can add an offset to the simulation start time computed by the GPS Timing Receiver. The value must be an integer between -3600 and +3600 seconds.

 **Caution:** As indicated in the " Simulator State" on page 26 section, it is important to know that when using a GPS Timing Receiver, any changes made to the settings while the simulator is in the "Armed state" will be discarded when the simulation starts.

 **Note:** This feature is only enabled with the SKY-SYNRT license.

3.10.0.5 Leap Seconds

You can specify the current leap seconds (LS) value and the date of the next leap seconds future (LSF) event.

Leap Seconds Δt_{LS}	18s
Leap Seconds Future Δt_{LSF}	18s on 2016-12-31

The LS value is used by the receiver to convert GPS system time to UTC time. NMEA data is marked with UTC timestamps. If the receiver and the simulator use different LS values to compute the UTC time, it will make the NMEA output

difficult to compare, especially in the receiver deviation graph (see "[Receiver](#)" on [page 205](#)).

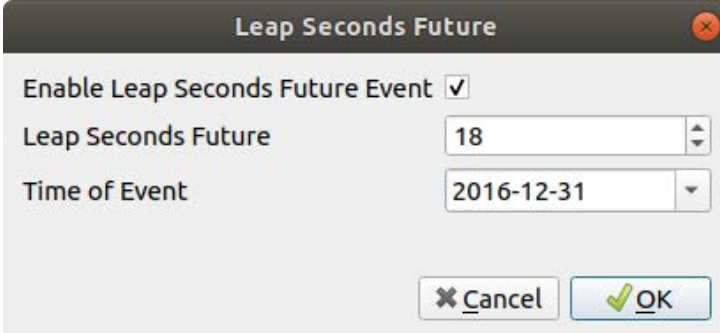

If you uncheck (disable) the LSF event, Skydel will set the LSF value in the navigation message to the current leap seconds value regardless of the LSF value that you entered.



Note: Leap Seconds (LS) and Leap Seconds Future (LSF) are relative to GPS Epoch. The corresponding LS and LSF for other constellations are adjusted accordingly.

If you enable the LSF event check box and the simulation start time is set for after the LSF event date, Skydel will use the LSF value as the current leap seconds value. You should keep in mind that the LSF event occurs at the end of the specified day, at exactly midnight UTC. You can see the effective leap seconds value (LS vs. LSF) in the dashboard.

Skydel allows any date for the leap seconds future event, but usually the date is set to either June 30th or December 31st.



Caution: When simulating LSF event for GLONASS (see "[Leap Seconds](#)" on [page 145](#)), consider the following limitations:
 GLONASS supports leap second event only at end of quarters (Mar 31st, June 30th, September 30th or December 31st).
 GLONASS does not support adding or subtracting more than 1 second during the event.

3.10.0.6 Duration

By setting the duration you can choose how long you would like the simulation to run. By default, the duration is set to Unlimited.

Click the dropdown box to select the desired duration. If you would like to specify a duration other than what is listed, select the Other option. You can then specify the amount of days, hours, minutes, and/or seconds you would like the simulation to run.

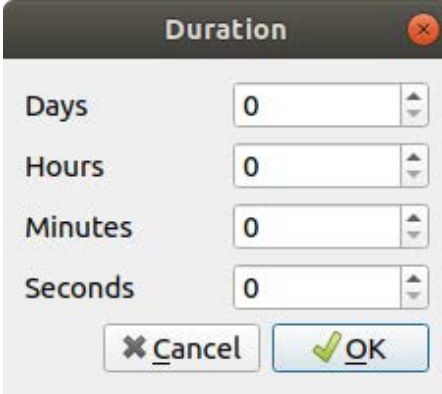

The image shows a dialog box titled "Duration" with a close button in the top right corner. Inside the dialog, there are four spinners labeled "Days", "Hours", "Minutes", and "Seconds", each with the value "0". At the bottom of the dialog, there are two buttons: "Cancel" and "OK".

3.11 Settings: Global

The Global settings are located in the **Settings - Global** sub-menu.

The Global sub-menu contains the "[Atmosphere](#)" below, "[Earth Orientation](#)" on page 82, "[Propagation Model](#)" on page 83, "[Signal Power](#)" on page 97, "[Synchronize Simulators](#)" on page 100 and "[Satellite Data Update](#)" on page 102 settings.

3.11.0.1 Atmosphere

The Atmosphere settings are located in the **Settings - Global - Atmosphere** menu.

The Atmosphere sub-menu contains the Nominal and Errors atmosphere settings.

Nominal

The Nominal atmosphere settings are located in the **Settings - Global - Atmosphere - Nominal** menu.

You can use the Nominal atmosphere settings to change the ionospheric and tropospheric models being applied to the simulation.

Tropospheric Model

Ionospheric Model

Klobuchar
 BDGIM
 NeQuick

	Alpha	Beta	
0	<input type="text" value="4.6570000e-09"/>	<input type="text" value="81920"/>	s
1	<input type="text" value="1.4900000e-08"/>	<input type="text" value="81920"/>	s/semicircle
2	<input type="text" value="-5.9600000e-08"/>	<input type="text" value="-65540"/>	s/semicircle ²
3	<input type="text" value="-1.1920000e-07"/>	<input type="text" value="-524300"/>	s/semicircle ³

RINEX File

The following ionospheric models are available:

- » None;
- » Klobuchar;
- » Spacecraft;
- » NeQuick;

The following tropospheric models are available:

- » None;
- » Saastamoinen;
- » Stanag;
- » DO-229;

The legacy Spacecraft ionospheric model is very basic and simple and meant to be used only for a vehicle in space, above the ionosphere. For the most part, the spacecraft will have a direct line of sight through empty space. However, when the GNSS satellites pass behind the Earth, the line of sight will go through the ionosphere for a short time. During that time, the effect on the GNSS signal is non-negligible.

For spacecraft simulations, the NeQuick model is the most efficient and recommended for spacecraft simulations. The NeQuick model is more complex than others so it is only computed periodically. The period T , is set to 1 second. The correction at a given time, t , will correspond to the correction at the last computed time. For example, the ionospheric correction, $C(t)$, for the NeQuick model is computed as follows: 1. $C(0 < t < T) = 0$. 2. $C(T < t < 2*T) = C(0)$ 3. $C(2*T < t < 3*T) = C(T)$...N. $C((N-1)*T < t < N*T) = C((N-2)*T)$

When selecting an Ionospheric model, the model is applied and affects the pseudo-range value of the satellites of all constellations. However, the navigation message will still be populated with values coming from the receiver model. For example, if you use the NeQuick model with a receiver that does not support it you might get some errors.

You can configure the NeQuick ionospheric model by importing MODIP and CCIR files. Click the Import button in the NeQuick tab. You will then be asked to provide an appropriate path. Sample files are located in “Skydel-SDX/Templates”.



Note: When you choose the Spacecraft model for the ionosphere, you should also set the tropospheric model to None.

Errors

The Errors atmosphere settings are located in the **Settings - Global - Atmosphere - Errors** menu.

You can use these settings to add positive offsets to the current ionospheric model.

“Apply delays to ionospheric model” needs to be checked to enable the errors when the simulation runs.

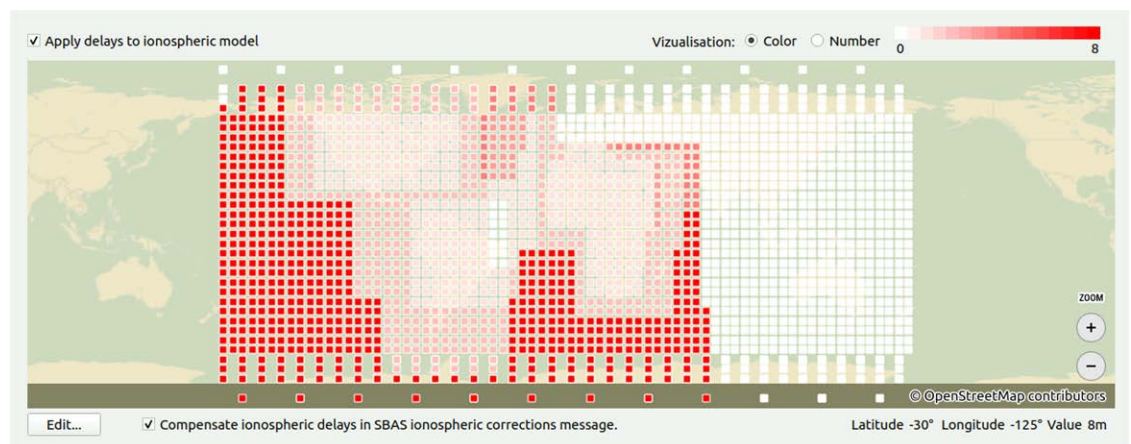

When the errors are enabled, the interactive map shows the current offsets at each Ionospheric Grid Points (IGP) of a ionospheric grid, with either colors or numbers.

Checking “Compensate ionospheric delays in SBAS long term corrections” will add these IGP values in the SBAS ionospheric corrections (message 26), see [“Manual Message Sequence” on page 153](#). This message contains the sum of the grid errors combined with the output of the configured ionospheric model. To

ensure the ionospheric corrections message uses exactly the same errors as the grid, the **None** ionospheric model must be selected on the [Nominal] page.

You can move and zoom the map to focus on areas of interest. Information related to the point highlighted with the mouse pointer are shown below the map.

The Edit button opens a dialog enabling the modification of the map's IGP values.

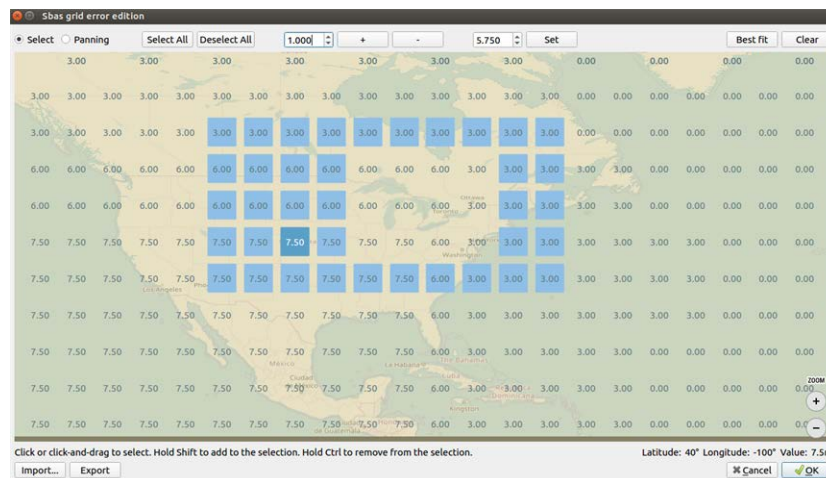

In "**Select**" mode, you can select points and modify their offset values. Selected points appear in blue, and their offset can be incremented/decremented by the value set in the field next to the +/- buttons. Alternatively, selected points can be set to the value indicated in the field next to the "Set" button.

While selecting with the mouse, holding the Shift Key on the keyboard will add to the current selection, while holding the CONTROL (CTRL) key will remove points from the current selection.

The "Clear" button will reset all the values on the map.

Use the "**Panning**" mode to move and zoom the map. The "Best fit" button will fit the whole points in the current canvas.

You can import or export a grid in CSV format, where each line describes a grid band (0 to 11), an IGP index (1 to 201, depending on the band) and the offset applied (0 to 99 meters).

Click OK to save your changes or click Cancel to revert them.

3.11.0.2 Earth Orientation

The Earth Orientation settings are located in the **Settings - Global - Earth Orientation** menu.

Default Earth Orientation Parameters range from January 1st to December 31st of the year of the default simulation start time.

The Import button opens a dialog to import Earth Orientation Parameters from a CSV file.

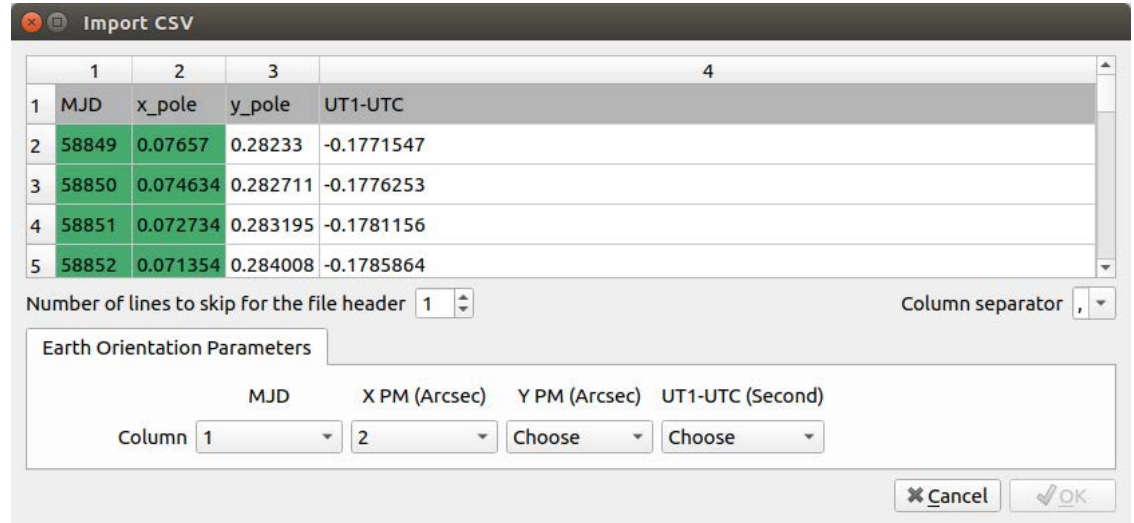

Below are the column descriptions for each Earth Orientation Parameter.

Column	Description
MJD	Modified Julian Date.
X PM, Y PM	Coordinates or the pole.
UT1-UTC	Difference between the Universal Time and Coordinated Universal Time.

3.11.0.3 Propagation Model

The Propagation Model settings are located in the **Settings - Global - Propagation Model** menu.

Propagation Model Type	Urban ▾
Open Sky Limit	60 Degrees
Obstruction Limit	40 Degrees
NLOS Probability	0.3
Random Seed	0
	Restore Defaults

In the Propagation Model settings page, you can set the Propagation Model you want to use for your simulation or set it to manual and customize the multipath yourself through each constellation tab.

This implementation defines three Propagation Models :

- » Rural
- » Suburban
- » Urban

Each has specific parameters affecting satellite signals, including power loss, pseudorange offset, Doppler offset, carrier phase offset, number of echoes, and the presence of a direct Line-of-Sight (LOS) signal.

Each environment has two elevation values that define three sky zones:

1. **Open Sky:** No multipath effects on the signal.
2. **Multipath Zone:** Signal affected by multipath, but the direct LOS signal is maintained.
3. **Obstruction Zone:** Signal affected by multipath with a chance of LOS signal deactivation.



The two elevation values and the Non-Line-of-Sight (NLOS) probability (which indicates the chance of LOS signal deactivation in the Obstruction Zone) can be set through the Settings page for each model. While the environment can change during a simulation, all satellites at a given time share the same environment, though their sky zones may differ based on elevation angles.

Since the models used for calculations are probabilistic, the results contain some randomness. To ensure stable configurations, you can set a random seed for each model type. Using the same random seed will produce consistent random values across simulation runs.

Once the environment model is set, the propagation environment is characterized by specific multipath parameters, which are automatically determined based on the chosen environment (urban, rural, suburban) and the satellite's sky zone. These parameters cannot be manually adjusted by the user.

Key parameters include:

- » **Delay:** (in ns) between the LOS and the specified echo, which can be converted to pseudorange offset.
- » **Amplitude distribution:** Rayleigh or Rice.
- » **Average amplitude:** relative to free space propagation (in dB), representing the ratio of the multipath echo's average amplitude to the LOS amplitude.
- » **Rice factor:** when relevant, specifies the amplitude distribution.

3.11.0.4 Logging

The Logging settings are located in the **Settings - Global - Logging** menu.

Raw Logging (csv)	<input type="checkbox"/>	10 Hz
NMEA File Logging	<input type="checkbox"/>	1 Hz
NMEA Serial Port Logging	<input type="checkbox"/>	0 ms
NMEA Sentences	<input checked="" type="checkbox"/> GGA <input checked="" type="checkbox"/> GLL <input checked="" type="checkbox"/> GSV <input checked="" type="checkbox"/> RMC <input checked="" type="checkbox"/> ZDA	
Downlink Logging	None	
RINEX Logging	<input type="checkbox"/>	
HIL Input Logging	<input type="checkbox"/>	
Logging Folder	C:/Users/tom.belda/Documents/Skydel-SDX/Output/Untitled	

Use the Logging settings to control how Skydel logs data during a simulation.

Raw

Turn on the Raw Logging option to log simulation data such as satellite trajectories, receiver trajectories, and signal power levels. You may also specify the desired update rate at which data is logged.



Note: If you need only raw data without RF signals, set your output to None and Skydel will generate the raw log files much faster than real time.



Caution: Raw logging at higher rates can interfere with the simulator's real-time engine on a slower computer. If you experience underrun problems with a radio, either reduce the logging rate or do not log at all while generating RF.

The logging data can be imported into other tools for analysis purposes. For example, you can use Skydel to generate satellite trajectory data. You can then use this data to model and test the satellite component of your receiver software. This enables you to test your software easily and quickly without the need to use hardware to generate RF signals.

When raw logging is enabled, Skydel will generate:

- » one file for each signal type per Skydel SV ID
- » one file for each multipath echo
- » one file for each visible dynamic transmitter (if using "[Advanced Jammer](#)" on page 186)
- » one file for the receiver

Below are the column descriptions for each raw logging files. Column descriptions for a **satellite**:

Column	Description
Elapsed Time	The elapsed time of the simulation in milliseconds.
ECEF X, Y, Z	ECEF coordinates (meters) of the origin of the transmitted signal (satellite's antenna phase center plus errors).
ECEF Error X, Y, Z	ECEF coordinates errors (offset in meters) from the satellite's antenna phase center.
Body Azimuth	Satellite's azimuth, in radians, from the receiver's body position relative to North.
Body Elevation	Satellite elevation, in radians, from the receiver's body position relative to the horizon.
Range	Geometrical distance, in meters, between the satellite's and receiver's antennas.
PSR	Pseudorange, in meters, between the satellite's and receiver's antennas.
ADR	Accumulated Doppler range, in number of cycles, between the satellite and receiver.
Clock Correction	Satellite's clock correction, in seconds.
Clock Noise	Additional clock error, in meters, not accounted for in navigation message.
Delta Af0	Clock offset in seconds.
Delta Af1	Clock drift in seconds per seconds.
Iono Correction	Ionospheric corrections, in meters.

Column	Description
Tropo Cor- rection	Tropospheric corrections, in meters.
PSR Offset	Pseudorange offset, in meters.
Receiver Antenna Azimuth	Satellite's azimuth, in radians, from the receiver's antenna position.
Receiver Antenna Elevation	Satellite's elevation, in radians, from the receiver's antenna position.
Receiver Antenna Gain	Receiver's antenna gain, in dBi.
SV Antenna Azimuth	Receiver's azimuth, in radians, from the satellite's antenna position.
SV Antenna Elevation	Receiver's elevation, in radians, from the satellite's antenna position.
Relative Power Level	Signal's relative power level, in dB, corresponding to the sum of the global power offset, the user's power offset, the receiver's antenna gain and the satellite's antenna gain.
Doppler Fre- quency	Doppler frequency, in Hertz, due to satellites' and receivers' antennas dynamics'.
PSR Change Rate	Pseudorange rate, in meters per second, due to satellites' and receivers' antennas dynamics'.
Receiver Carrier Phase Off- set	Phase offset, in radians, caused by the receiver's antenna phase pattern. This column does not appear in echo log files.
Satellite Car- rier Phase Offset	Phase offset, in radians, caused by the satellite's antenna phase pattern. This column does not appear in echo log files.
Echo Power Loss	Multipath power offset, in dB, relative to Line of Sight (LOS) signal. This column appears only in echo log file.

Column	Description
Echo Doppler Offset	Multipath frequency offset, in Hertz, relative to LOS signal. This column appears only in echo log file.
Echo Carrier Phase Offset	Initial phase offset, in radians, in multipath relative to LOS signal. This column appears only in echo log file.
Echo PSR Offset	Multipath pseudorange offset, in meters. This column appears only in echo log file.
GPS TOW	GPS time of week, in seconds.
GPS Week Number	GPS week number.
SBAS tO	SBAS time of the day, in seconds.
PSR satellite time	The elapsed time of the simulation when the signal was emitted from the satellite, in milliseconds.

Column descriptions for **receiver**:

Column	Description
Elapsed Time	Elapsed time of the simulation, in milliseconds.
ECEF X, Y, Z	ECEF coordinates of the receiver's antenna, in meters.
Yaw, Pitch, Roll	Sum of vehicle's body and antenna's rotation angles, in degrees.
Velocity X, Y, Z	Velocity of vehicle, in meters per second.
Accel. X, Y, Z	Acceleration of vehicle, in meter/seconds.
GPS TOW	GPS time of week, in seconds.
GPS Week Number	GPS week number.

Column descriptions for a **transmitter**:

Column	Description
Elapsed Time	Elapsed time of the simulation, in milliseconds.
ECEF X, Y, Z	ECEF coordinates of the transmitter's body, in meters.

Column	Description
Yaw, Pitch, Roll	Transmitter's body rotation angles, in degrees. Does not include antenna rotation.
Transmitter Antenna Gain	Transmitter antenna gain, in dB.
Propagation loss	Power loss, in dB, due to the distance between transmitter and receiver.
Receiver Antenna Gain	Receiver's antenna gain, in dBi.
Receiver Visibility	True if the transmitter is visible from the receiver, false otherwise.

NMEA

Skydel can also log NMEA-style data. This data will look like the output of a receiver that has tracked the simulation, and will follow the v4.10 NMEA standard. You can choose to output it in a file or in a serial port and add delay to the logging. This can be useful for testing your post-processing tools, or for connecting Skydel to another device that accepts NMEA data. You may also specify the desired update rate at which data is logged.



Resources: For detailed information and instructions on logging NMEA data, please see "[NMEA Serial Port Logging](#)" on page 306.



Note: Skydel uses GPS time (not UTC) in its NMEA output. Also, the altitude in the GGA sentence is based on the ellipsoid model, not the mean sea level.

Downlink

It is also possible to log downlink data. The downlink can be logged before message encoding, after, or both. For a message to be logged, the transmitting satellite has to be present.

The downlink format changes depending on the signal type.

For **BeiDou D1 and D2**, the encoding uses interleaving. Each word uses the following format:



GLONASS encoding uses hamming code. The format is:



For **GPS L1 C/A** and **QZSS L1 C/A**, the encoding uses parity. Every data word uses the following format:



The example below is a sample of L1 C/A downlink log.

```
Elapsed Time (ms), Skydel SV ID, PRN, GPS TOW, GPS Week Num-
ber, Subframe, Page, Navigation Message (Hex), Modified
0, 1, 1, 370800.000, 2006, 1, , 22D55589 21D2DEA4 3D644032
2AAAAA95 1555556A 2AAAAA95 15557CFB 3F6925EF 3FC0079E
3E17C87C, No
```

GPS CNAV uses CRC encoding. The format is the following:



GPS L1C uses CRC encoding. The format is the following:

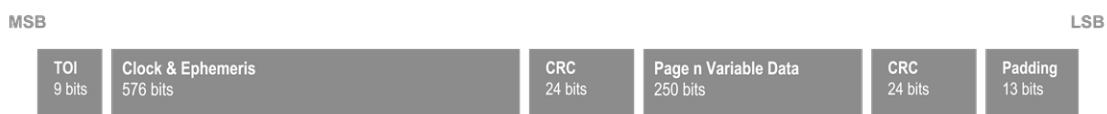

The L1C message is then encoded using BCH, LDPC and interleaving. The encoded format is the following:



BeiDou B1C uses CRC encoding. The format is the following:



The B1C message is then encoded using BCH, LDPC and interleaving. The encoded format is the following:



Galileo FNAV uses CRC & FEC encoding. The format is the following:

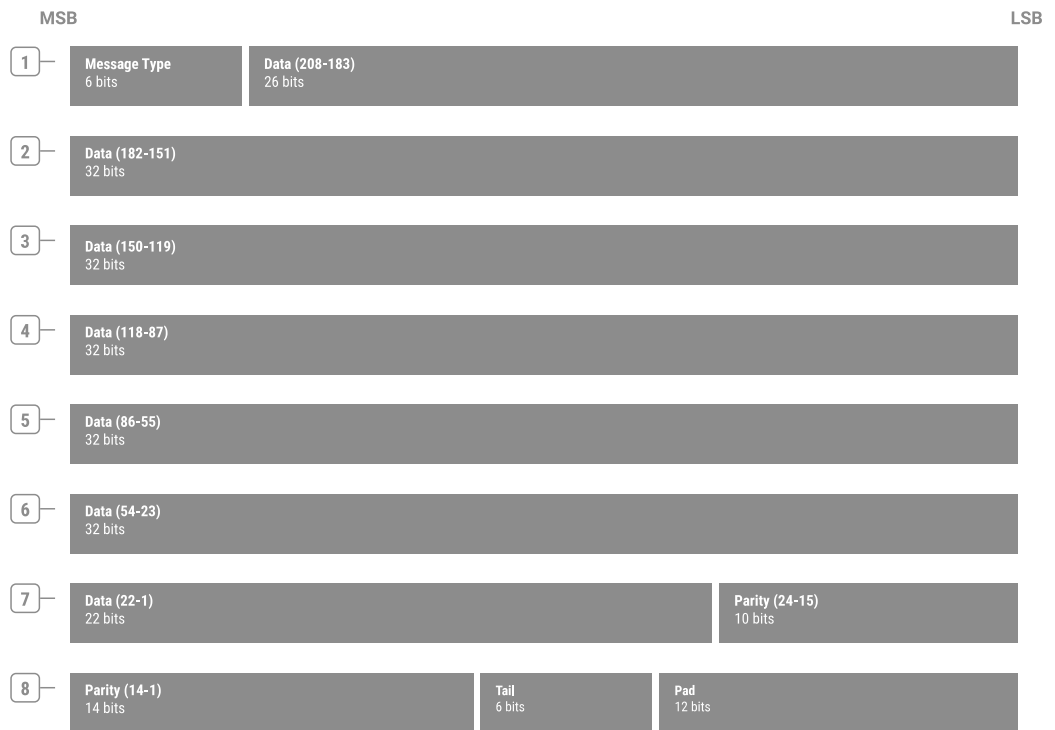

Galileo INAV uses CRC & FEC encoding. The format is the following:

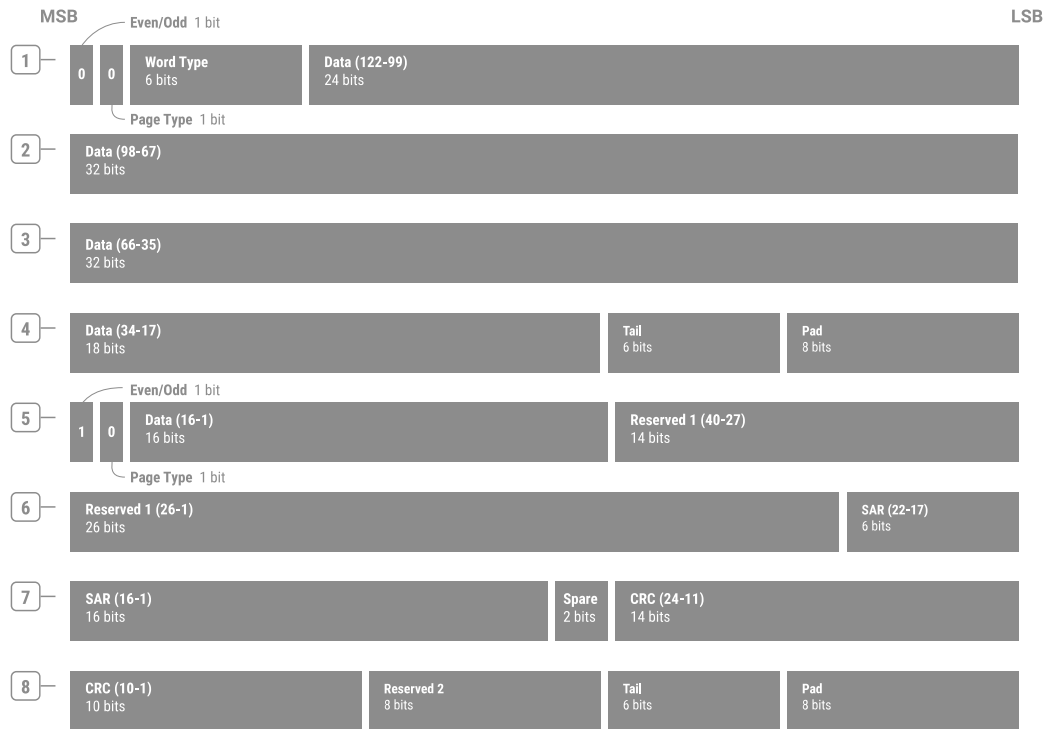

SBAS uses FEC encoding. The format is the following:

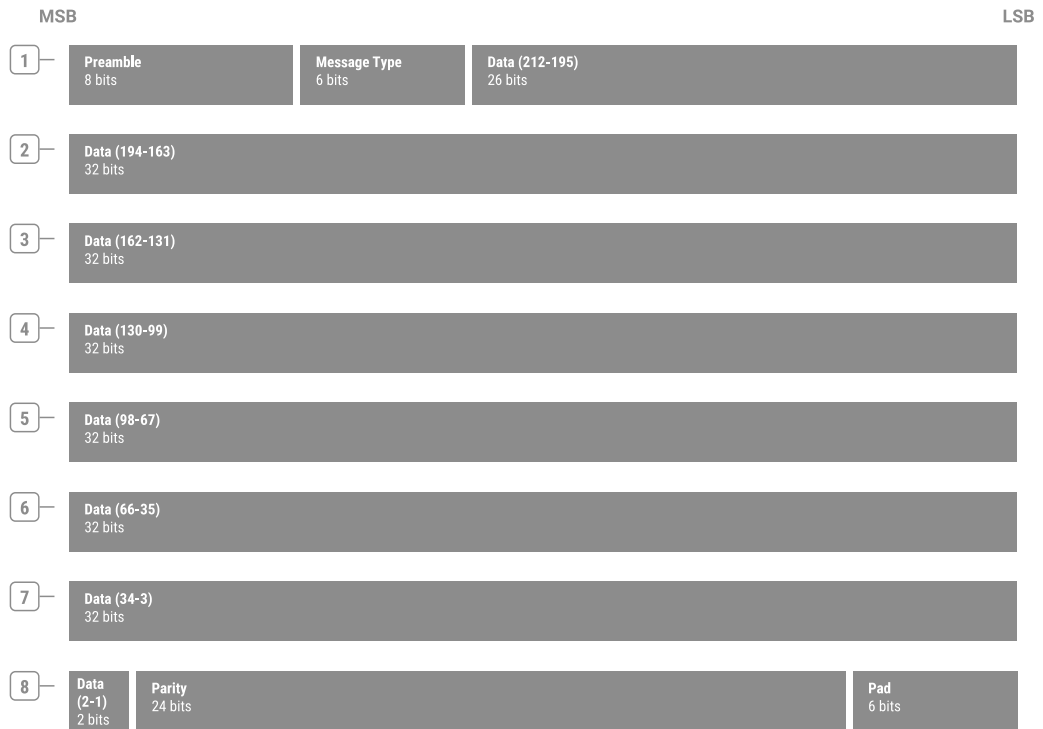

" Message Modification" on page 111 are included in the logged data.

Skydel includes a Python library to parse the downlink log. The script will parse every line in the log to extract the data in a more usable format. It also includes an example that will parse a downlink log and generate a human-readable output such as this:

```

Paramater Name,Range,Binary Value,DecimalValue,Unit
Preamble,[0, 7],10001011,139,
TLM Message,[8, 21],010101010101,5461,

ISF, [22, 22], 1, 1,
Reserved, [23, 23], 0, 0,
Parity 1, [24, 29], 001001, 9,
Truncated TOW Count, [30, 46], 01111000101101001, 61801,
AF, [47, 47], 0, 0,
AS, [48, 48], 0, 0,
SubFrame ID, [49, 51], 001, 1,
PC 1, [52, 53], 01, 1,
Parity 2, [54, 59], 100100, 36,
WN, [60, 69], 1111010110, 982, week
Code L2, [70, 71], 01, 1,
SV Accuracy (URA), [72, 75], 0001, 1,
    
```



Note: The data logging sampling rate for RINEX Navigation is:

GPS: Every 7200 seconds.

GLONASS: Every 1800 seconds.

Galileo: Every 600 seconds.

BeiDou: Every 3600 seconds.

QZSS: Every 3600 seconds.

SBAS: Just one batch at the start of the simulation.

NavIC: Every 4800 seconds.

PULSAR: Every 3600 seconds.

HIL Input

When HIL Input Logging is checked, the data received from the HIL interface is logged as is. This is useful to determine what was actually received from a remote computer. This data can be compared with the receiver's trajectory included in the Raw Logging to determine if the HIL input was properly processed by Skydel. Logging at 1000 Hz will also reveal any HIL input problem that may have occurred during the simulation.

3.11.0.5 Signal Power

The Signal Power settings are located in the **Settings - Global - Signal Power** menu.

Global Offset

Dynamic Range Offset

Signal Offset

GPS	GLONASS	Galileo	BeiDou	SBAS	QZSS	NavIC	PULSAR
GPS L1 C/A	<input style="width: 50px;" type="text" value="3.0 dB"/>				GPS L1ME	<input style="width: 50px;" type="text" value="-1.5 dB"/>	
GPS L1C	<input style="width: 50px;" type="text" value="4.5 dB"/>				GPS L2ME	<input style="width: 50px;" type="text" value="-1.5 dB"/>	
GPS L2C	<input style="width: 50px;" type="text" value="1.5 dB"/>				GPS L1MR	<input style="width: 50px;" type="text" value="-1.5 dB"/>	
GPS L1 P-Code	<input style="width: 50px;" type="text" value="0.0 dB"/>				GPS L2MR	<input style="width: 50px;" type="text" value="-1.5 dB"/>	
GPS L2 P-Code	<input style="width: 50px;" type="text" value="0.0 dB"/>				GPS L5	<input style="width: 50px;" type="text" value="4.5 dB"/>	

Reference power -131.5 dBm (Minimum RF signal strength at 5 degrees of elevation)

Signal Strength Model

You can use the Signal Power settings to control the output power of the satellite signals being generated relative to the nominal value, which depends on your hardware setup. When you configure the output, (see ["Settings: Output" on page 63](#)), you can click on the ["Reference Power Level" on page 69](#) button to see the nominal value of your hardware. To adjust the power level of the transmitted signal, you can either change the Global offset or the offset specific to the code type that you are adjusting. By default, Skydel uses a 0 dB global offset, and a realistic offset for all of the other code types. This will correctly model the fact that not all constellations and code types are generated at the same power level. For example, according to the specifications, P-Code should operate at 3 dB less than C/A code.

When using the default settings, the transmit power of a GPS C/A code signal has 80 dB of gain. Typically, for a vehicle on Earth, this will translate into a power level of -45 dBm (measured at the TX port of a X300 radio). When using 60 dB of attenuation, this -45 dBm signal will become -110 dBm. This is the correct power level to simulate a 20 dB LNA. You may refer to the power level section for more details, see ["Power Levels: Live Sky vs. Simulation" on page 5](#).



Note: To model the noise floor correctly on the X300 Ettus radio, you should use 80 dB of attenuation and a real 20 dB LNA.

There are three ways you can increase or decrease the power level of a signal:

- » global power offset (+30 dB to -45 dB);
- » code-specific power offset (+10 dB to -45 dB);
- » power sliders (+10 dB to -45 dB);

By using any of these three options, you can obtain a +50 dB increase in the power level of a generated signal. However, it is not recommended to push the power levels this high on too many satellites. At some point, it will end up saturating the I/Q data samples. When this happens, Skydel will warn you that I/Q has been saturated.

If you need to increase the global power offset by more than 30 dB, you can remove some of the attenuation instead.

If your simulation requires high power signals (such as LEO constellations for example) and I/Q saturation occurs, use the Dynamic Range Offset parameter to increase the saturation limit. This setting changes the available I/Q dynamic range, therefore affecting the reachable power levels for the generated signals as well as the available range of the power sliders in the Constellations tab. So, increasing the offset allows higher signal power in the simulation. If saturation occurs in your simulation, increasing the offset can help eliminate it.



Note: Increasing this offset directly increases the RF gain of the SDR.

You can enable or disable the “Signal Strength Model” by checking or unchecking the box.

The Signal Strength Model adjusts the transmit power of each satellite by modeling the following effects:

- » power loss due to the distance between the satellite and the receiver;
- » power loss due to the antenna pattern of the satellite itself. Use the “[Antenna](#)” on [page 138](#) settings to modify patterns.



Note: The power loss due to the antenna pattern of the receiver is not part of the Signal Strength Model. Use the Vehicle “[Antenna](#)” on [page 181](#) settings to enable or disable receiver antenna modeling.

3.11.0.6 Synchronize Simulators

The Synchronize Simulators settings are located in the **Settings - Global - Synchronize Simulators** menu.

You can use the Synchronize Simulators settings to specify how Skydel instances connect to each other to perform the synchronization. This setting will be used for both multiple Skydel instances running on the same computer as well as synchronization among multiple computers (see [Multiple Radios - Multi-instance \(RTK\)](#)).

Determine which Skydel instance will be the Main. Check the Sync Time (Main) check box on that instance of Skydel. Skydel will then begin listening for incoming connections.

Sync Time (Main instance)	<input checked="" type="checkbox"/>	Listening on port 4567 (1 Connection)
Sync Time (Worker instance)	<input type="checkbox"/>	Sync client is not running

Check the Sync Time (Worker) checkbox on each remaining instance of Skydel. These Skydel instances will then connect to the Main instance.

Sync Time (Main instance)	<input type="checkbox"/>	Sync server is not running
Sync Time (Worker instance)	<input checked="" type="checkbox"/>	Connected to 127.0.0.1:4567

At this point, all Skydel instances are connected and will synchronize their radios.

Once you start the simulation on the Main instance, each Skydel instance should start running automatically. It does not matter whether each Skydel instance are running on the same computer, or separate ones.



Note: If you are using only one instance of Skydel, and only one Ettus radio such as the X300, you might want to check the Sync Time (Main) checkbox. This will force the radio to use the PPS from an external source. This is important if you are planning on using the PPS output to perform time-error analysis.

3.11.0.7 Synchronize configuration between Main and Workers

Skydel is capable of pushing a Main instance's configuration to all of the workers. To do so, in the main instance of Skydel, go to the **Settings - Global - Synchronize Simulators** section.

The screenshot displays the 'Global Settings' interface for Skydel. At the top, there are two rows for synchronization: 'Sync Time (Main instance)' with a checked checkbox and 'Listening on port 4567 (1 Connection)', and 'Sync Time (Worker instance)' with an unchecked checkbox and 'Sync client is not running'. Below this is a section titled 'Broadcast configuration to worker instances computer(s)'. It contains a 'Broadcast now' button, a checkbox for 'Automatically broadcast configuration on simulation start', and an 'Exclude from broadcast:' section with six checkboxes: 'Radios*', 'Vehicle Motion', 'Interference', 'Outputs and Radios**', 'Vehicle Antenna', and 'Plug-in'. At the bottom of this section, there are two explanatory footnotes: '* When Radios are excluded, the worker instance computer(s) will retain radios' IP and Clock settings, while the other settings will be copied (Signal Selection, Gain, etc). Radios are matched if their names are identical.' and '** When Outputs and Radios are excluded, the worker instance computer(s) will retain all their radios settings.'

Pushing the configuration can be done either manually by clicking the **Broadcast now** button. It can also be automatically broadcast at every simulation start by checking the **Broadcast configuration on simulation start** checkbox.

Applying exclusions is used to control which parts of the Workers' configuration will be retained. For example, if you check the **Vehicle Motion** filter, after a configuration broadcast all the Workers will use the Main's configuration, except for the vehicle motion. This can be useful to simulate the same scenario with different vehicles.

When the Skydel Main broadcast a configuration, radios are associated by their names. For example, "Radio 1" on the Main instance will be matched to "Radio 1" on the Worker(s). When excluding **Radios** only, only the physical radio configuration (IP address and Clock) will be retained by the Worker(s). The output signals configuration will be pushed. To exclude both, check the **Outputs and Radios** option.

3.11.0.8 Synchronize Simulators with a GPS Timing receiver

It is possible to use the GPS Time from the "[GPS Timing Receiver Time](#)" on [page 77](#) as the start time of the simulation for all instances of Skydel. For example, this can be very handy when simulating RTK scenarios and you don't want to reset the GNSS receivers at each simulation.

In this case, only the Main instance of Skydel needs to be connected to the GPS Timing Receiver.

For the Main instance: in the "Start Time" settings screen, "GPS Time" must be set to "GPS Timing Receiver Time".

For the Worker instance(s): in the "Start Time" settings screen, "GPS Time" must be set to "Custom Time".

When starting the simulation, the Main instance will read the "GPS Timing Receiver" time. This will become the GPS simulation's start time. The Main instance will push this value to each of the Worker instances.

In order to have synchronized simulators, each radio must be connected with a common 10 MHz and PPS signal as indicated in the [Simulation Hardware Components](#) section.

3.11.0.9 Satellite Data Update

The Satellite Data Update settings are located in the **Settings - Global - SV Data Update** menu.

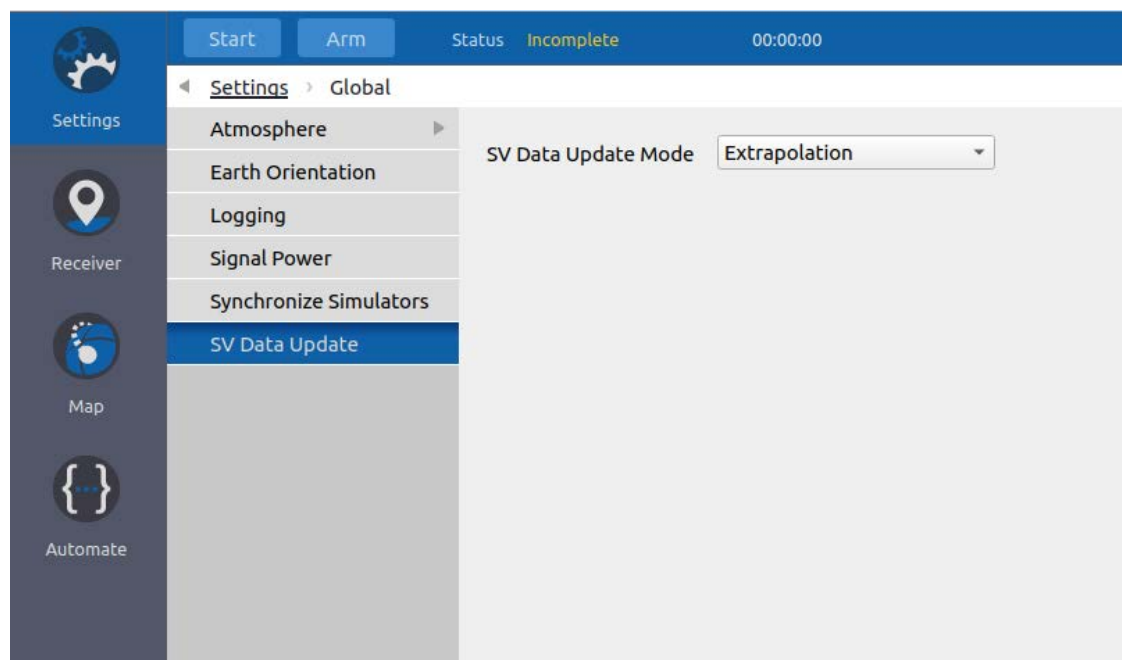

Use the settings in this page to control how Skydel updates satellite data during a simulation.

There are two different modes to choose from:

- » Extrapolation
- » Dynamic

The selection of the mode is done either directly in the interface or using the API command `SetSVDataUpdateMode`.

Extrapolation Mode

If this mode is selected, Skydel uses the satellite data found in the configuration and extrapolates it forward in time during the simulation. The configuration's satellite data comes from imported files. If no files were imported by the user, Skydel defaults to the files found in the Skydel-SDX/Templates folder. In the case where multiple blocks are present for a satellite in an imported file, Skydel will only use one. As the simulation advances, the initial block is extrapolated and used for the satellite's trajectory, ephemeris and almanac.

See sections Import the RINEX file ("[General](#)" on page 106) and Data Sets (see "[Data Sets](#)" on page 108) for information regarding the import of satellite data files.

Dynamic Mode

When selected, Skydel uses satellite data that is dynamically pushed by the user to the engine using the Skydel API (see "[Application Programming Interface \(API\)](#)" on page 211). To push a block of satellite data, the `PushDynamicSVData` command is used.



Note: This mode is currently only available for the following constellations: GPS, Galileo, BeiDou, QZSS, NavIC and PULSAR.

In Dynamic mode, Skydel only simulates satellites blocks that are pushed. This means Skydel does not use any default or imported satellite data file. In addition, it is possible to start a simulation without any satellites and dynamically add them during the simulation.

When Skydel first receives a block of data for a satellite, it adds that satellite to the simulation. The received block is used to compute the satellite's trajectory, ephemeris, and almanac. Skydel continues to use this block of data until a new block is received or until the end of the simulation if no new block is pushed by the user.

When receiving additional blocks of satellite data, Skydel uses the new block of data to compute its trajectory and ephemeris (the almanac is not updated with additional blocks). For the trajectory of the satellite, Skydel interpolates between the previous block of data and the new block of data. This interpolation ensures that no jumps occur in the satellite's trajectory. At the end of the interpolation, Skydel drops the previous block and only uses the new block. The duration of this interpolation depends on the constellation. Blocks can't be sent during the interpolation period.

The interpolation durations follow this table:

Constellation	Interpolation Duration (seconds)
GPS	3600
Galileo	300
BeiDou	1800
QZSS	1800
NavIC	2400
PULSAR	1800

Python API example

The Python API directory under "Skydel-SDX/API/Python" contains an example script to use Skydel in the Dynamic Update Mode: `example_dynamic_sv_data.py`.

This script uses a Rinex navigation file containing satellite data blocks for many satellites. It parses the file and pushes the blocks to Skydel at the start of the simulation. See section import the RINEX file ("[General](#)" on page 106) and Data Sets ("[Data Sets](#)" on page 108) for information regarding satellite data files.



Note: This example script only pushes the first block of satellite data for each satellite at the start of the simulation. The same approach can be used to push new blocks of satellite data at a later time during the simulation.



Note: The script used to parse the Rinex navigation file is also provided: `rinex_parser.py`.

Although this example uses a Rinex navigation file, the user is not restricted to the use of this file format – in fact, any satellite data source can be used. Skydel only requires the block of data to be formatted in a particular way, so some parsing may be necessary before pushing the block. See the documentation of the command `PushDynamicSVData` as well as the parsing script `rinex_parser.py`.

The `example_dynamic_sv_data.py` script starts by connecting to the simulator:

```
sim = RemoteSimulator(True)
sim.connect()
sim.setVerbose(True)
```

Then, amongst other configuration, it sets Skydel into the Dynamic Update Mode:

```
sim.call (SetSVDDataUpdateMode (SVDDataUpdateMode.Dynamic))
```

Once the configuration is done, the simulator is then armed:

```
sim.arm()
```

The script then parses the Rinex file and obtains the satellite data blocks using the `rinex_parser.py` script, where `rinex_file_path` is the path to the Rinex file.

```
rinex_parser = RinexParser()
blocks = rinex_parser.parse(rinex_file_path)
```

Next, it iterates over the parsed blocks and pushes them to Skydel:

```
for block in blocks:
    sim.post (PushDynamicSVDData (system, block.sv_id, block.toc,
    block.params))
```

Finally, the script starts the simulation and disconnects the script from the simulator:

```
sim.start()
sim.disconnect()
```

The same script can be used at a later time during the simulation to push new blocks of satellite data. In the case of pushing blocks of data during simulation, only the code to parse the file and push blocks is needed. The code to configure the simulator, arm and start the simulation should not be used as the simulation is already running.

3.11.0.10 Terrain Obscuration (Plugin)

Skydel can simulate terrain obstruction effects on jamming and spoofing signals through an available plugin. The Terrain settings are located in the ["Terrain Obscuration" on page 280](#) section.

3.12 Settings: Constellations

» ["Custom Constellation" on page 163](#)

In addition, there are many subsections that apply to many of these constellations: ["Data Sets" on page 108](#), ["Message Modification" on page 111](#), ["Message Sequence" on page 120](#), ["Orbits" on page 121](#), ["Perturbations" on page 124](#), ["Clock & Group Delay" on page 125](#), ["Health" on page 126](#), ["Multipath" on page 126](#), ["Signal Enable/Disable" on page 130](#), ["Transmitted PRN" on page 133](#), ["Filter Assignment" on page 134](#), ["Errors" on page 136](#), and ["Antenna" on page 138](#).

The following topics are included in this section:

- 3.12.1 GPS 106
- 3.12.2 GLONASS 143
- 3.12.3 GALILEO 145
- 3.12.4 BEIDOU 149
- 3.12.5 QZSS 150
- 3.12.6 NavIC 152
- 3.12.7 SBAS 153
- 3.12.8 PULSAR 163
- 3.12.9 Custom Constellation 163

3.12.1 GPS

The GPS settings are located in the **Settings - GPS** sub-menu.

GPS settings control the orbits, downlink data, and signals of the GPS satellites. These settings have no effect on other constellations (i.e., GLONASS, Galileo, BeiDou, QZSS and NavIC), except SBAS. Some [" Errors" on page 136](#) can be corrected with [" SBAS" on page 153](#).

3.12.1.1 General

The General settings are located in the **Settings - GPS - General** menu.

The General settings control the "Issue of Data" (IODC and IODE) of the downlink data. Disabling the checkbox "Override RINEX IODE" makes Skydel use the IODE values from the RINEX instead of the value indicated in the "Issue of Data" button.

The "almanac first upload" offset controls when the first almanac update will occur after the simulation starts. The update can occur in the middle of a message as illustrated in the image below.

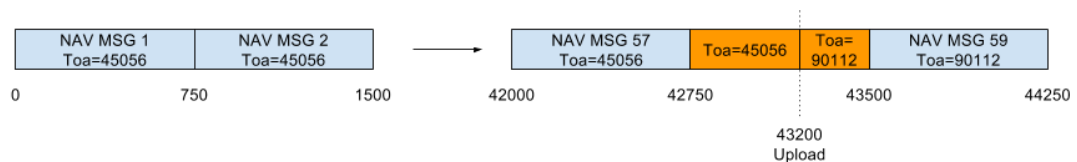

By default, the first update will occur 12 hours (43200 seconds) after the start of the simulation. This setting can be changed independently of the update interval. For example, you could set the first update to occur at 300 seconds and then every 43200 seconds after that first update.

In the general settings, you can also import a RINEX Navigation, YUMA, SEM or TLE file to set the orbits of the GPS Satellites.



Note: SP3 files cannot be imported from the General Settings. Go to the Data Sets menu if you want to import a SP3 file for the orbit. For more information, see "[Data Sets](#)" on the next page.

To import a RINEX navigation file:

1. Click the Import button in the General settings screen.
2. You will then be asked to provide a RINEX-compatible file.
3. After selecting the file, Skydel will prompt you to confirm. If the file contains multiple navigation message types, Skydel may prompt you to select which type to import.

The list below notes the EPH navigation message types currently supported by Skydel for each constellation:

- » GPS: LNAV, CNAV, CNAV-2
- » GLONASS: FDMA
- » GALILEO: INAV, FNAV, CNAV
- » BEIDOU: D1, CNAV-1, CNAV-2, CNAV-3
- » QZSS: LNAV, CNAV, CNAV-2, SLAS, PVT, CLAS
- » NAVIC: LNAV, L1
- » SBAS: SBAS
- » PULSAR: XLNAV, X1, X5

Importing a RINEX file will override each of the current "[Orbits](#)" on page 121, "[Perturbations](#)" on page 124, "[Clock & Group Delay](#)" on page 125, and "[Health](#)" on page 126 settings for all space vehicles included in the file. Missing satellites will automatically be marked as not present but previous satellite data will be preserved. Note that ionospheric parameters of the RINEX files are not imported.



Note: RINEX Source

RINEX navigation message files can be found here: <https://cd-dis.nasa.gov/archive/gnss/data/daily> ↗

A registered account is needed to access the RINEX files.

For information on navigating in the database and finding the desired RINEX files, please use the following resources from NASA:
For daily navigation data on all constellations:

https://cddis.nasa.gov/Data_and_Derived_Products/GNSS/daily_30second_data.html ↗

For daily broadcast ephemeris data specifically for GPS and GLONASS: https://cddis.nasa.gov/Data_and_Derived_Products/GNSS/broadcast_ephemeris_data.html

The “signal propagation delay” should always be checked. When unchecked, the propagation delay and the Doppler shift are removed from the simulation. This feature is useful for calibrating the simulator’s PPS with an oscilloscope before measuring or calibrating a timing receiver. If you want to use Skydel to calibrate or verify the calibration of a timing receiver, contact Safran Trusted 4D Canada’s technical support.

3.12.1.2 Data Sets

The data sets settings are located in the **Settings - GPS - Data Sets** menu. This menu manages the different data sets imported in the configuration.



Note: These settings are not available for the SBAS and GLONASS constellations.

A data set describes the state of the satellites in the constellation. This includes orbital, health, perturbation, and signal control information for all satellites. Different data sets can be used to simulate specific parameters for satellite orbits as well as the information transmitted in ephemeris and almanac parts of the navigation messages. Data sets are imported using RINEX Navigation, SEM, YUMA, TLE or SP3 files.

In the Data Sets settings page, each column represents an imported data set. Each row represents a type of data set to which a data set is assigned. The data set types are:

- » Ephemeris - parameters from this data set will be used in the “ephemeris” part of the navigation message.
- » Almanac - parameters from this data set will be used in the “almanac” part of the navigation message.
- » Orbit - parameters from this data set will be used to compute the position of the SV’s.

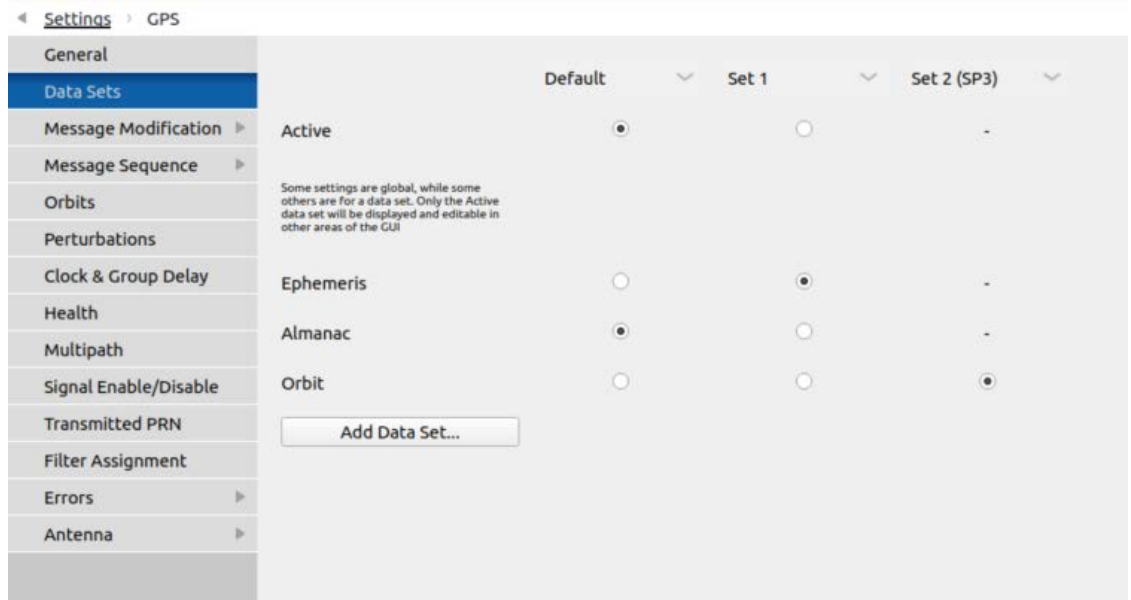

Adding a Data Set

To add a data set to the configuration, click the "Add Data Set..." button and select the RINEX, SEM, YUMA, TLE or SP3 parameter file to import. If you select a RINEX file, Skydel may prompt you to select which navigation message type to import (refer to the "GPS" on page 106 section for more details). The name of the data set will by default be the name of the imported file. All data set names must be unique.

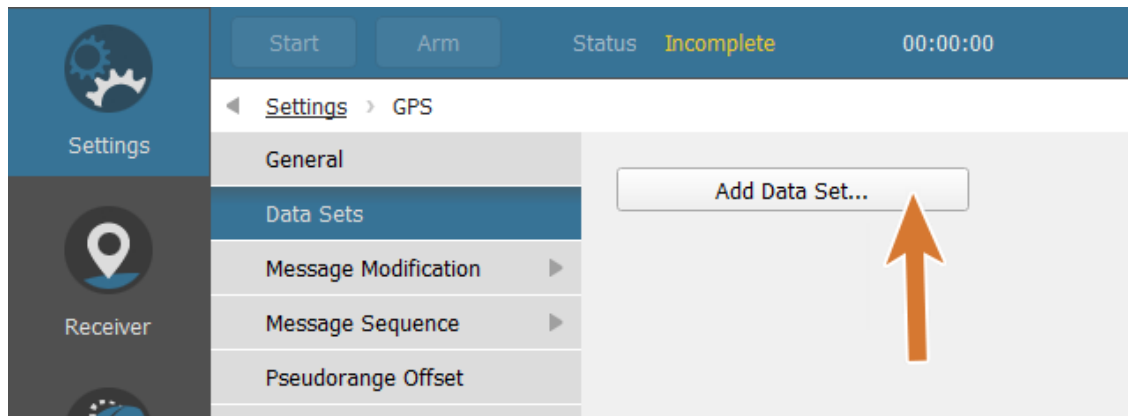

By default, there is only the default data set and it is not displayed in the page as shown in the image above.



Note: Keep the following in mind with regard to SP3 formats:

- » SVs are not simulated outside the time span covered by the SP3 file.
- » Position and clock information between records are interpolated using 7-point Lagrange interpolation.
- » Velocity information is ignored.
- » Only records from the selected constellation are imported.
- » Reference frames are assumed to be WGS84-compatible.
- » Both SP3-c and SP3-d formats are supported.

Active Data Set

The active data set is the working set of the user. It is the data set that is displayed in the other settings pages like "[Orbits](#)" on page 121, "[Perturbations](#)" on page 124, "[Clock & Group Delay](#)" on page 125, and "[Health](#)" on page 126 settings. The name of the current active data set is displayed at the top of these pages. Modifying fields in one of these pages will modify the active data set. Switching to another active data set will not revert the changes made on the previous active data set. SP3 data sets cannot be active.

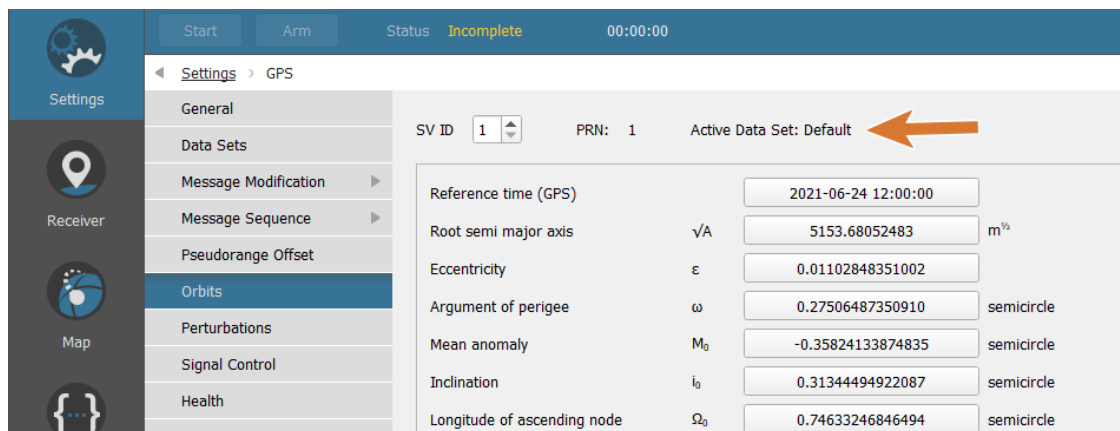

The screenshot shows the 'Settings' page for GPS. The 'Active Data Set' is set to 'Default', indicated by an orange arrow. The interface includes a sidebar with navigation options: Settings, Receiver, Map, and Multi-sets. The main content area shows the 'GPS' settings, including a 'General' tab, 'Data Sets', 'Message Modification', 'Message Sequence', 'Pseudorange Offset', 'Orbits', 'Perturbations', 'Signal Control', 'Health', and 'Multi-sets'. The 'Orbits' section is currently active, displaying parameters for SV ID 1 and PRN 1. The parameters are as follows:

Parameter	Value	Unit
Reference time (GPS)	2021-06-24 12:00:00	
Root semi major axis	5153.68052483	m ^{1/2}
Eccentricity	0.01102848351002	
Argument of perigee	0.27506487350910	semicircle
Mean anomaly	-0.35824133874835	semicircle
Inclination	0.31344494922087	semicircle
Longitude of ascending node	0.74633246846494	semicircle

By default, the active data set is the default data set.

Assigning a Data Set

Each row (Ephemeris, Almanac, Orbit) represents the assignments of data sets to these data set types. Only one data set can be assigned to a specific data set type - each row is mutually exclusive.

By default, all data set types are assigned to the default data set.



Note: SP3 data sets can only be assigned to the orbit data set type. With SP3, you should also provide Ephemeris and Almanac data sets that cover the same time period.

Actions on Data Sets

By clicking on any of the data set's name, a menu containing the following actions will appear:

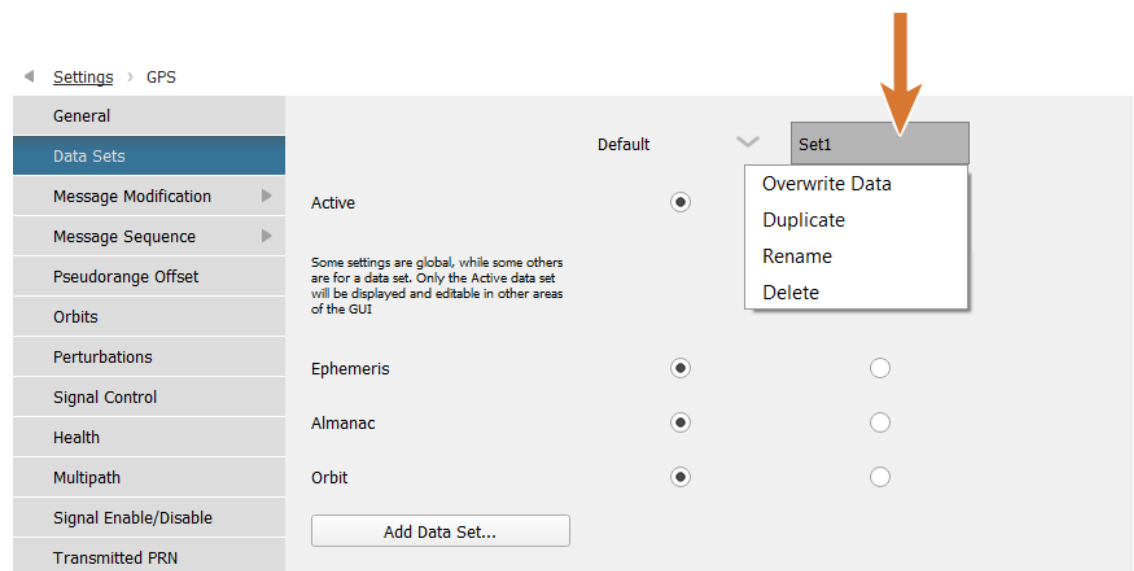

- » Overwrite data - replace the parameters of the data set with the ones from a new RINEX, SEM, YUMA or TLE file. SP3 data sets cannot be overwritten.
- » Copy - create a duplicate of the data set.
- » Rename - change the name of the data set.
- » Delete - remove the data set from the list.



Caution: Changing assignment of data sets may affect SV's status see "[Signal Enable/Disable](#)" on page 130 section.

3.12.1.3 Message Modification

The Message Modification settings are located in the **Settings - GPS - Message Modification** menu.

Up to four sub-menus can be present:

LNAV

Use this page to modify the navigation message for L1C/A, as well as P-Code on L1 and L2.

CNAV

Use this page to modify the navigation message for L2C and L5.

CNAV-

Use this page to modify the navigation message for L1C.

2

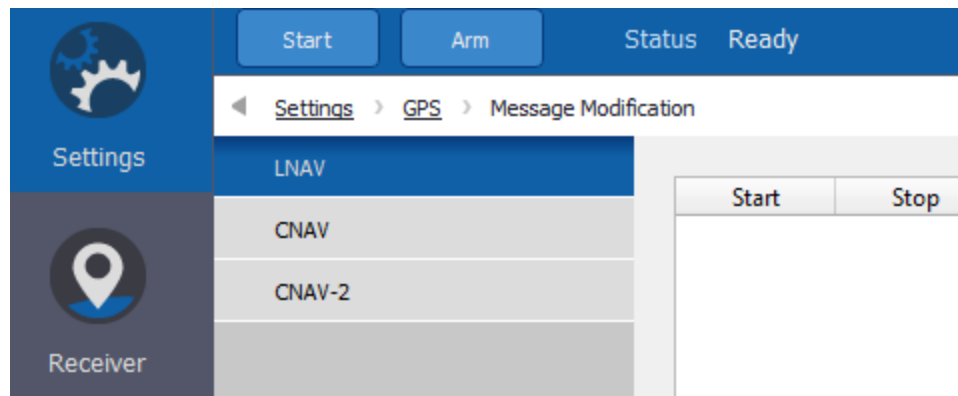

Note: If only the GPS L1C/A and P-Code features are active, the Message Modification menu displays directly the LNAV message modification page.

Message Modification settings let you override the downlink data being transmitted by the GPS satellites.

All Message Modifications globally work the same way. The modifications will be applied only if all their specified conditions are met. Some conditions are common to all navigation message types like start time, stop time, sender SV ID and signals. And some are special to the navigation message type (subframe, page, message type, word, etc...).



Note: If a subframe is partially overlapped by the start and stop time interval, the subframe is considered to be inside the interval.

Messages modifications can be added either in idle mode or during a simulation. During a simulation, the message modification events are applied at the start of the next navigation message respecting the event's conditions.

 **Note:** For users sending message modification events during a simulation using the RAPI, take into account the network latency in addition of the latency preference.

LNAV

To create a navigation message modification for L1C/A and P-Code, go to **Settings - GPS - Message Modification - LNAV** and click the Add button.

When creating a message modification, you may choose the start and end time relative to the start of the simulation. In the example shown below, the message modification will begin 15 minutes into the simulation, and will end 30 minutes into the simulation. You can also control which SVs, signals, sub-frames, pages, and words are affected by the modification. You may set bits to 0, 1, or X. The X indicates that the bit will be negated (0 becomes 1, and 1 becomes 0). By default, message modifications will re-compute the parity bits so that the message passes parity. You may disable this by unchecking the “Calculate parity” check box. This is considered to be a form of message corruption because the message will no longer pass parity.

Add Navigation Message Modification

Modifications / Corruptions are applied to LNAV message only when all Conditions are met. Click Help for more details.

Conditions

Start	00:15:00		Signals	Subframe	3
Stop	00:30:00	<input checked="" type="checkbox"/>	C/A	Page	
SV ID	All		<input type="button" value="Change..."/>	Word	4

Modifications / Corruptions

Bit 1 →	X	-	0	-	1	-	0	-
	0	-	0	-	1	-	0	-
	0	-	0	-	1	-	0	- ← Bit 24
	-	-	-	-	-	-	-	← Parity Bits

Calculate parity and bearing bits after event (Modification vs. Corruption)
 Enable bit negation (0 becomes 1, 1 becomes 0)



Note: The “X” on the first indicates that it will be negated (0 becomes 1, and 1 becomes 0). Bit negation is disabled by default; enable it by selecting “Enable bit negation”.

To select the signals which will receive the modification, click on the Change button. Select All to apply to all possible signals, or Selection to manually select which one you want.

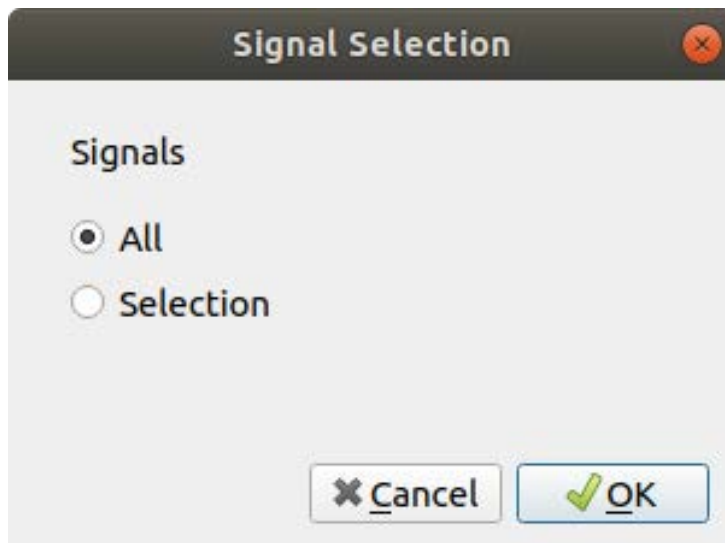

The Add button will add the message modification to the list. The dialog box will stay open so that you may easily add a similar message modification. When you are done creating modifications, close the dialog box.

	Start	Stop	SV ID	Signals	Subframe	Page	Word	Modification	Type
1	0:15:00	0:30:00	All	C/A	3	N/A	4	X-0-1-0- 0-0-1-0- 0-0-1-00 - - - - -	Modification

To edit a message modification, simply select the desired line in the list and click on the Edit button.



Note: The navigation message sub-frames and pages are aligned with the beginning of the GPS week. When you set the start and stop times for the modification, they are relative to the simulation start time, not GPS time. Changing the simulation start time could make the message modification ineffective because the specified sub-frame and page are no longer transmitted at the specified modification start and stop times.

CNAV

To create a navigation message modification for L2C or L5, go to **Settings - GPS - Message Modification - CNAV** and click the Add button.

Add Navigation Message Modification ✖

Modifications are applied to CNAV message only when all Conditions are met.
Click Help for more details.

Conditions

Start	00:20:00	⬆	⬇	⬆	⬇
Stop	00:00:00	⬆	⬇	⬆	⬇
SV ID	All	▾			
Signals	All	Change...			
Message Type	10 - Ephemeris 1				
Content Match				Add...	Remove

Modifications

	Add...
	▲ Move Up
	▼ Move Down
	Change... Remove

Calculate CRC after event (Modification vs. Corruption)

Help
Add
✖ Close

Similar to LNAV message modification, CNAV modifications are defined with conditions and modifications. The modifications (or corruptions) are applied only when each of the conditions are met.

Besides the usual conditions such as start, stop, signals and SV ID, you may specify the message type. You may also specify the message content to match. For example, you may specify that a modification has to be applied only if a portion of the message is matching an expected value. Click the Add button on the Content Match row to enter the expected value.

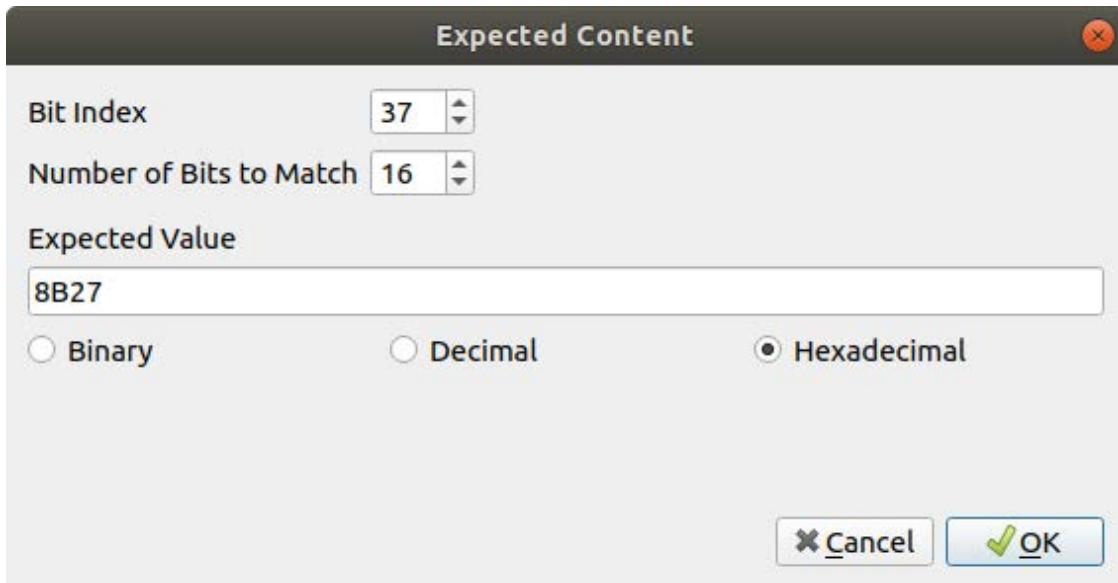

The dialog box titled "Expected Content" has a close button (red X) in the top right corner. It contains the following fields and controls:

- Bit Index:** A numeric input field with the value 37 and a small up/down arrow icon to its right.
- Number of Bits to Match:** A numeric input field with the value 16 and a small up/down arrow icon to its right.
- Expected Value:** A text input field containing the value 8B27.
- Radio Buttons:** Three radio buttons are located below the text field, labeled "Binary", "Decimal", and "Hexadecimal". The "Hexadecimal" radio button is selected.
- Buttons:** Two buttons are located at the bottom right: "Cancel" (with an X icon) and "OK" (with a checkmark icon).

Click OK to close the Expected Content dialog box. The content match condition is automatically formatted into a string, becoming in this example:

```
EQUAL(37, 16, 0x8b27)
```

Add Navigation Message Modification ✕

Modifications are applied to CNAV message only when all Conditions are met. Click Help for more details.

Conditions

Start	00:20:00	⬆ ⬇ ⬆	
Stop	00:00:00	⬆ ⬇ ⬆	<input type="checkbox"/>
SV ID	All	▼	
Signals	All	Change...	
Message Type	10 - Ephemeris 1 ▼		
Content Match	EQUAL(37, 16, 0x8b27)	Change...	Remove

Modifications

	<div style="margin-bottom: 5px;">Add...</div> <div style="margin-bottom: 5px;">▲ Move Up</div> <div style="margin-bottom: 5px;">▼ Move Down</div> <div style="margin-bottom: 5px;">Change...</div> <div>Remove</div>
--	--

Calculate CRC after event (Modification vs. Corruption)

Help
Add ✕ Close

Note: You can leave the Content Match condition empty.

Because the CNAV message is 300 bits long and it is not subdivided in words like the LNAV message, it is impractical to show a dialog box with 300 buttons to specify the modifications. Instead, modifications are defined for portions of the message. To do so, click Add in the Modifications section.

Modification ✕

Bit Index ↕

Modification 12

Similar to LNAV message modification, you can force bits to zero or one, or you can invert them (i.e., 0 becomes 1 and 1 becomes 0) using the X symbol. In the example above, the modification 1 - - 0 x x 0 - 1 1 0 1 applies to bits 120 through 131. The table below shows this modification in details.

Bit	Modification
120	Set to one
121, 122	Unchanged
123	Set to zero
124, 125	Inverted
126	Set to zero
127	Unchanged
128, 129	Set to one
130	Set to zero
131	Set to one

Click OK to add the modification. You can add as many modifications as you require.

Add Navigation Message Modification ✕

Modifications are applied to CNAV message only when all Conditions are met. Click Help for more details.

Conditions

Start

Stop

SV ID

Signals

Message Type

Content Match

Modifications

120:1--0XX0-1101
212:0011
230:00000000

Calculate CRC after event (Modification vs. Corruption)

Once you are finished adding modifications, click Add to add the event to the list.

	Start	Stop	SV ID	Signals	Message Type	Condition	Modification	Type
1	0:20:00	0:00:00	10	All	10	EQUAL(37, 16, ...	120:1--0XX0-1101, 212:0011, 23...	Modification

CNAV-2

To create a navigation message modification for L1C, go to **Settings - GPS - Message Modification - CNAV-2** and click the Add button.

CNAV-2 modifications are similar to CNAV message modification. The "message type" condition is replaced with a "page" condition.

3.12.1.4 Message Sequence

The Message Sequence settings appear in the menu only if GPS L2C, L5, M-Code and/or L1C features are enabled on your [license](#).

If more than one of these features are enabled, the Message Sequence settings are located in the **Settings - GPS - Message Sequence** menu.

If only one of these features is enabled, the **Message Sequence** menu is replaced with the appropriate settings screen (**L2C Message Sequence**, **L5 Message Sequence**, or **CNAV-2 Message Sequence**).

Use the Message Sequence settings to modify the transmission order of L2C or L5 messages. Once all messages have been transmitted, the satellites will loop back to the beginning of the sequence.

	Type	Occurrence	Description
1	10	1	Ephemeris 1
2	11	1	Ephemeris 2
3	30	1	Clock, IONO and Group Delay
4	33	1	Clock and UTC
5	10	2	Ephemeris 1
6	11	2	Ephemeris 2
7	30	2	Clock, IONO and Group Delay
8	12	1	Reduced Almanac
9	10	3	Ephemeris 1
10	11	3	Ephemeris 2
11	30	3	Clock, IONO and Group Delay
12	12	2	Reduced Almanac
13	10	4	Ephemeris 1
14	11	4	Ephemeris 2
15	30	4	Clock, IONO and Group Delay
16	37	1	Clock and Midi Almanac

Use the Message Sequence settings to modify the different pages of L1C messages. The messages will loop on the enabled pages.

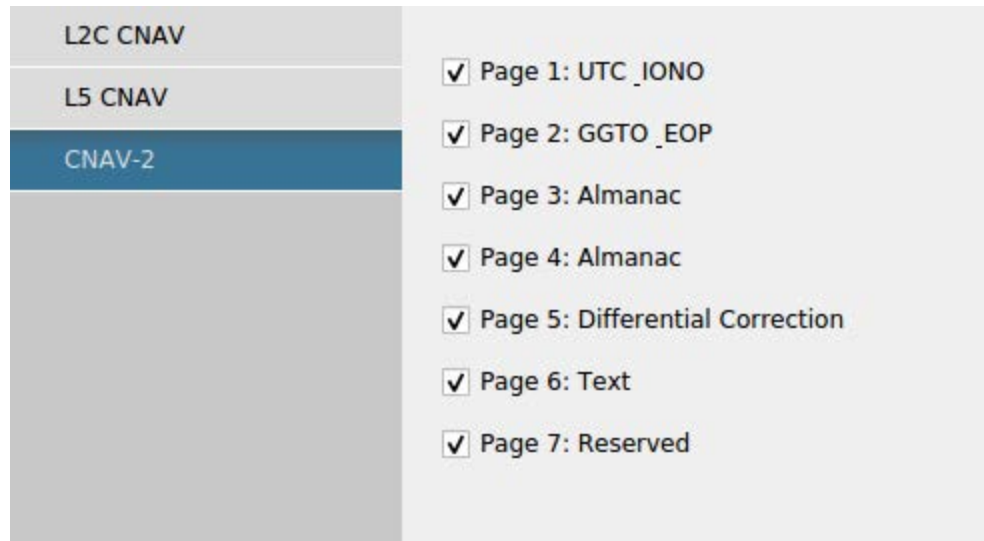

3.12.15 Orbits

The Orbits settings are located in the **Settings - GPS - Orbits** menu.

You can use the Orbits settings to control the locations of the satellites within the constellation. To make a change to a satellite's orbit, you must first select the appropriate SV ID.

SV ID PRN: 8

Reference time (GPS)		<input type="text" value="2020-03-31 00:00:00"/>	
Root semi major axis	\sqrt{A}	<input type="text" value="5153.64785576"/>	$m^{1/2}$
Eccentricity	ϵ	<input type="text" value="0.00531734642573"/>	
Argument of perigee	ω	<input type="text" value="-0.03970740875220"/>	semicircle
Mean anomaly	M_0	<input type="text" value="-0.70404483377965"/>	semicircle
Inclination	i_0	<input type="text" value="0.30879426794129"/>	semicircle
Longitude of ascending node	Ω_0	<input type="text" value="0.95734897069590"/>	semicircle
Mean motion difference	Δn	<input type="text" value="1.43006673169940e-09"/>	semicircle/s
Inclination rate	i_{dot}	<input type="text" value="-1.86446413863266e-11"/>	semicircle/s
Right ascension rate	Ω_{dot}	<input type="text" value="-2.59501575783366e-09"/>	semicircle/s
Change rate in semi-major axis	A_{dot}	<input type="text" value="0.00000000"/>	meters/sec
Rate of mean motion difference	Δn_{dot}	<input type="text" value="0.000000000000000"/>	semicircle/sec ²
Update sat. position during simulation		<input checked="" type="checkbox"/>	
Geostationary		<input type="checkbox"/>	

Click the value of an orbital parameter to modify it. When modifying a parameter, you have the option to replicate this value for all remaining satellites.

Edit Parameter ✕

Eccentricity

Minimum: 0 **Maximum: 0.5**

If you want to remove Doppler shift on the satellite, you can uncheck the “Update sat. position during simulation” checkbox. This will violate the laws of physics and suspend the satellite in a fixed location relative to the Earth. This can be useful for certain types of testing.

The Orbits settings will display the parameters of the active data set (see "Data Sets" on page 108).

Geostationary

You can also put a GPS satellite on a geostationary orbit. To do so, simply check the **Geostationary** box. You will notice that the orbital parameters are automatically changed to reflect the geostationary orbit. These parameters are read-only when the geostationary box is checked.

SV ID PRN: 8

Reference time (GPS)		<input type="text" value="2018-06-17 00:00:00"/>	
Root semi major axis	\sqrt{A}	<input type="text" value="6493.39467621"/>	$m^{1/2}$
Eccentricity	ϵ	<input type="text" value="0.0000000000000000"/>	
Argument of perigee	ω	<input type="text" value="0.0000000000000000"/>	semicircle
Mean anomaly	M_0	<input type="text" value="0.0000000000000000"/>	semicircle
Inclination	i_0	<input type="text" value="0.0000000000000000"/>	semicircle
Longitude of ascending node	Ω_0	<input type="text" value="-0.4055555555555556"/>	semicircle
Mean motion difference	Δn	<input type="text" value="0.0000000000000000e+00"/>	semicircle/s
Inclination rate	$i\dot{0}$	<input type="text" value="0.0000000000000000e+00"/>	semicircle/s
Right ascension rate	$\Omega\dot{0}$	<input type="text" value="0.0000000000000000e+00"/>	semicircle/s
Change rate in semi-major axis	$A\dot{0}$	<input type="text" value="0.00000000"/>	meters/sec
Rate of mean motion difference	$\Delta n_0\dot{0}$	<input type="text" value="0.0000000000000000"/>	semicircle/sec ²
Update sat. position during simulation		<input checked="" type="checkbox"/>	
Geostationary		<input checked="" type="checkbox"/>	
Geostationary longitude		<input type="text" value="-73.00"/>	°

When the Geostationary box is checked, the satellite longitude can be modified. Click on the button to enter the desired value.



Caution: When you check the Geostationary box, it changes the orbital parameters. When you uncheck the Geostationary box, the previous orbital parameters are not restored. The values stay the same and match the last geostationary longitude entered.

If your last actions were made in this settings panel and you want to restore the orbital parameters to what they were before you checked the geostationary box,

you can use the Undo command (Ctrl+Z) several times until you rollback to the desired settings.

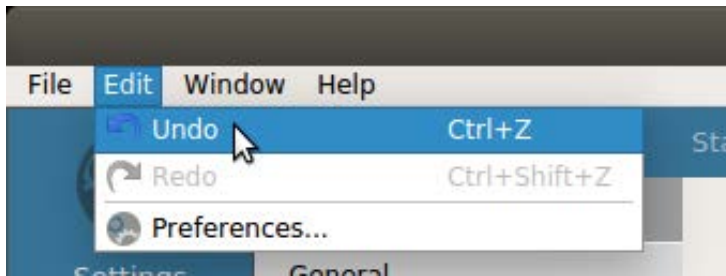

3.12.1.6 Perturbations

The Perturbations settings are located in the **Settings - GPS - Perturbations** menu.

The Perturbations settings can be used to modify the harmonic corrections of the satellite's orbit. To make a change to a satellite's perturbations, you must first select the appropriate SV ID.

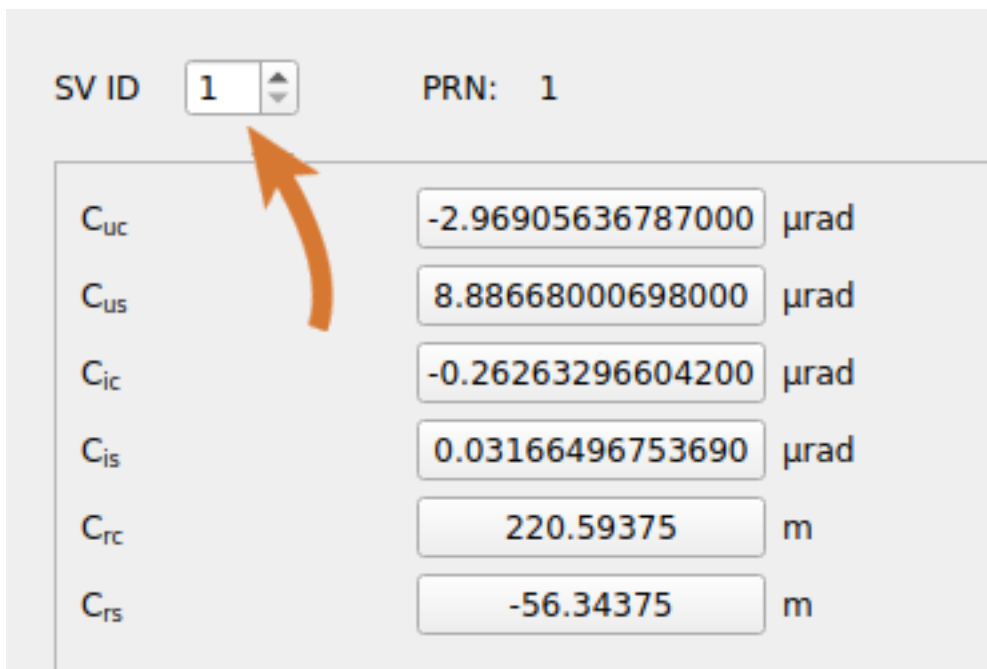

Parameter	Value	Unit
C_{uc}	-2.96905636787000	μrad
C_{us}	8.88668000698000	μrad
C_{ic}	-0.26263296604200	μrad
C_{is}	0.03166496753690	μrad
C_{rc}	220.59375	m
C_{rs}	-56.34375	m

You can easily clear the perturbations for a satellite by clicking the Clear Sat button. You can clear the perturbations for all satellites by clicking the Clear All Sat button.

The Perturbations settings will display the parameters of the active data set (see ["Data Sets" on page 108](#)).

3.12.1.7 Clock & Group Delay

The Clock & Group Delay settings are located in the **Settings - GPS - Signal Control** menu.

You can use the Clock & Group Delay settings to modify the satellite clock errors and inter-signal biases. To make a change to a satellite's clock and group delay, you must first select the appropriate SV ID.

SV ID	PRN
1	1

Clock Bias	a_{f0}	-3.43252439052000e-04	s
Clock Drift	a_{f1}	-1.20508047985000e-11	s/s
Clock Drift Rate	a_{f2}	0.00000000000000e+00	s/s ²
Group Delay	T_{GD}	5.58794	ns
ISCL1C/A	Available	<input checked="" type="checkbox"/>	Apply to all
	Delay	0.00000	ns
ISCL2C	Available	<input checked="" type="checkbox"/>	Apply to all
	Delay	-3.61508	ns
ISCL515	Available	<input checked="" type="checkbox"/>	Apply to all
	Delay	-4.43274	ns
ISCL5Q5	Available	<input checked="" type="checkbox"/>	Apply to all
	Delay	-4.43274	ns
ISCL1CP	Available	<input checked="" type="checkbox"/>	Apply to all
	Delay	0.00000	ns
ISCL1CD	Available	<input checked="" type="checkbox"/>	Apply to all
	Delay	0.00000	ns
Transmitted PRN	This setting was moved here		

Changing the availability of a clock correction term will only affect the downlink data and not the pseudorange.

The Clock & Group Delay settings will display the parameters of the active data set (see "[Data Sets](#)" on page 108).

3.12.1.8 Health

The Health settings are located in the **Settings - GPS - Health** menu.

Use the Health settings to modify the health bits being broadcast by the satellites. These values will be broadcast in the ephemeris, the almanac, and in the page 25 health message. To make a change to a satellite's health you first have to select the appropriate SV ID.

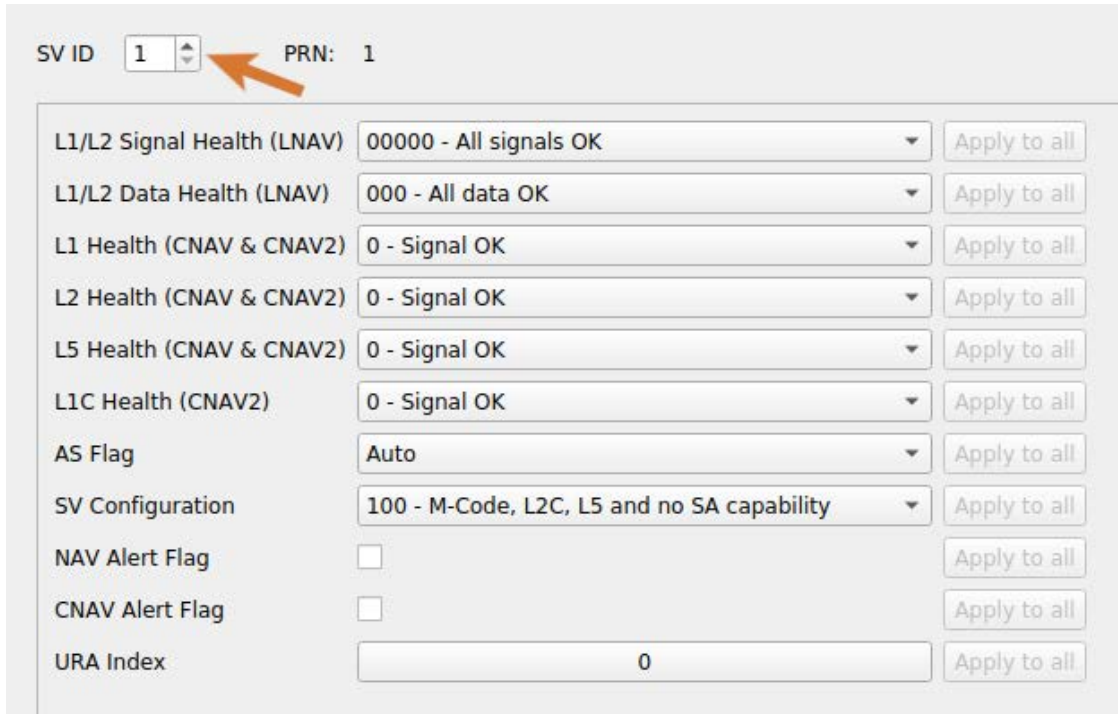

SV ID PRN: 1

L1/L2 Signal Health (LNAV)	00000 - All signals OK	Apply to all
L1/L2 Data Health (LNAV)	000 - All data OK	Apply to all
L1 Health (CNAV & CNAV2)	0 - Signal OK	Apply to all
L2 Health (CNAV & CNAV2)	0 - Signal OK	Apply to all
L5 Health (CNAV & CNAV2)	0 - Signal OK	Apply to all
L1C Health (CNAV2)	0 - Signal OK	Apply to all
AS Flag	Auto	Apply to all
SV Configuration	100 - M-Code, L2C, L5 and no SA capability	Apply to all
NAV Alert Flag	<input type="checkbox"/>	Apply to all
CNAV Alert Flag	<input type="checkbox"/>	Apply to all
URA Index	0	Apply to all

Use the Apply-to-all button to apply the health bits to all satellites.

L1/L2 Signal Health and Data Health are applied to the NAV message for both L1 C/A and P-Code signals. L1, L2 and L5 Health Bits are applied to the CNAV message for L2C signals. L1C Health Bit is applied to the CNAV-2 message for L1C signals. If the health value indicates that the signal is not being transmitted and you want the satellite to stop transmitting the signal, you must manually turn off the RF in the "[Signal Enable/Disable](#)" on page 130 screen.

The Health settings will display the parameters of the active data set (see "[Data Sets](#)" on page 108).

3.12.1.9 Multipath

The Multipath settings are located in the **Settings - GPS - Multipath** menu.

To simulate multipath propagation, each path (or echo) must be entered manually. To replicate a NLOS (Non-Line-of-Sight) scenario, it's also possible to disable the direct line of sight so that only echoes will reach the receiver antenna. To do so, uncheck the **Line of Sight (LoS) Enabled** box.

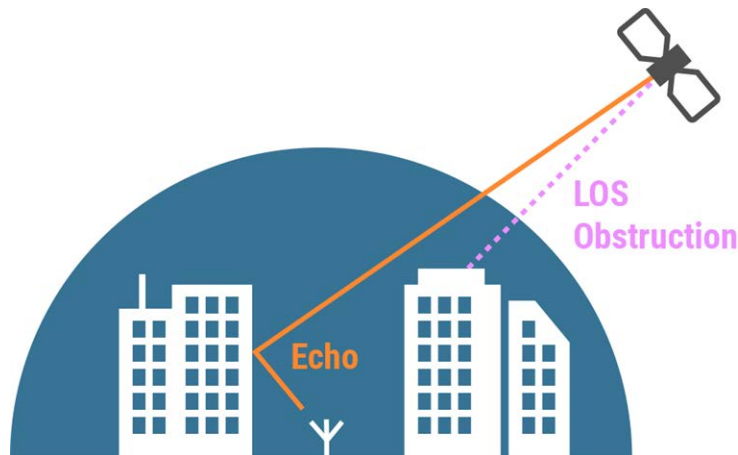

For each echo, you can control 4 fundamental attributes: pseudorange offset, power loss, Doppler shift and carrier phase offset.

SV ID PRN: 1

Signal

Enabled	<input checked="" type="checkbox"/> Echo 1	<input type="checkbox"/> Echo 2	<input type="checkbox"/> Echo 3	<input type="checkbox"/> Echo 4	<input type="checkbox"/> Echo 5
Pseudorange Offset (m)	<input type="text" value="35.000"/>	<input type="text" value="0.000"/>	<input type="text" value="0.000"/>	<input type="text" value="0.000"/>	<input type="text" value="0.000"/>
Power Loss (dB)	<input type="text" value="12.000"/>	<input type="text" value="0.000"/>	<input type="text" value="0.000"/>	<input type="text" value="0.000"/>	<input type="text" value="0.000"/>
Doppler Shift (Hz)	<input type="text" value="0.000000"/>	<input type="text" value="0.000000"/>	<input type="text" value="0.000000"/>	<input type="text" value="0.000000"/>	<input type="text" value="0.000000"/>
Carrier Phase Offset (deg)	<input type="text" value="0.000"/>	<input type="text" value="0.000"/>	<input type="text" value="0.000"/>	<input type="text" value="0.000"/>	<input type="text" value="0.000"/>

Line of Sight (LoS) Enabled

Pseudorange offset

This value indicates the extra distance the echo signal has to travel before reaching the receiver's antenna. The effect is a time delay between the Line Of Sight signal and the echo signal being added. Note that the time delay is applied to the **code** and to the **carrier** of the echo.

Power loss

This value indicates the power loss of the echo signal compared to the Line Of Sight signal. A value of +10dB indicates the echo signal will be 10dB lower than the LoS.

Doppler shift

The Doppler shift of an echo indicates the frequency offset the echo signal has compared to the Line of Sight (LOS) signal. The Doppler Shift will affect the **carrier's** phase and frequency as well as the transmission time of the **code** chips.

Carrier phase offset

The Carrier phase offset is a value added to the echo's initial carrier phase, compared to the Line Of Sight's carrier phase. The value has to be set between -180.0 and + 180.0 degrees.

For each satellite, you can add up to 5 echoes per signal.



Note: Adding an echo for GPS L1C/A will not automatically add an echo for the other signals on the same satellite: L1P, L2P, L2C, etc. Each of them has to be added individually.

To disable echoes, click on Disable Echoes button. A window will open, letting you specify the echoes that you want to disable.

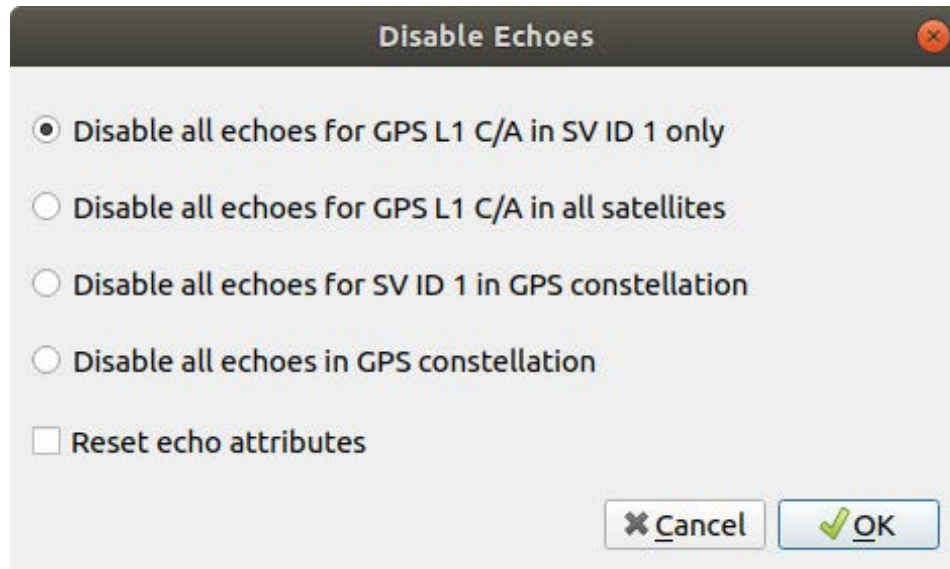

Check the Reset echo attributes box if you also want to reset the echo attributes (pseudorange offset, power loss, etc.). Otherwise, the echo will be disabled. However, the attributes will be preserved so that you can enable them in the future with the same values.



Caution: Each echo requires as much calculation as the direct line of sight signal calculation. Therefore, adding many echoes can tax the GPU significantly. Make sure your graphic card is suitable for a large number of multipath echoes. The impact on the CPU is marginal.

Click the Summary button to view all multipath echoes in a table format.

SV ID	LoS	Signal	Echo	Enabled	PSR Offset (m)	Power Loss (dB)	Doppler Shift (Hz)	Carrier Phase Offset (Deg)	
1	1	Yes	C/A	1	Yes	35.000	12.000	0.000	0.000
2	1	Yes	L2C	1	Yes	25.000	12.100	0.000	0.000
3	4	Yes	C/A	1	Yes	45.000	13.000	0.000	0.000
4	4	Yes	C/A	2	Yes	16.000	9.000	0.000	0.000
5	4	Yes	L2C	1	Yes	45.000	16.000	0.000	0.000
6	4	Yes	L2C	2	Yes	13.000	9.100	0.000	0.000

LoS

A value of Yes means the direct line of sight signal reaches the receiver antenna. A value of No means only the echoes (if any) will reach the receiver antenna.

Enabled

Enables or disables the echo. If you set the other parameters, but leave the Enabled flag to No (unchecked), **the echo will not be simulated**. This attribute has no effect on the direct line of sight signal.



Resources: [Creating an Automated Multipath GNSS Signal Scenario ↗](#)

3.12.1.10 Signal Enable/Disable

The Signals settings are located in the **Settings - GPS - Signal Enable/Disable** menu.

Use the Signals settings to modify which signals are being broadcast by the satellites. The RF column controls if any signal will be transmitted at all from that satellite. The other columns can turn individual signal types on and off.

If you uncheck the Present flag, it will not transmit any RF and all the other satellites will indicate this satellite as unhealthy.

	Present	RF	C/A	L2C	L1 P-Code
All SV ID	<input checked="" type="checkbox"/>	<input checked="" type="checkbox"/>	<input checked="" type="checkbox"/>	<input checked="" type="checkbox"/>	<input checked="" type="checkbox"/>
1	<input checked="" type="checkbox"/>	<input checked="" type="checkbox"/>	<input checked="" type="checkbox"/>	<input checked="" type="checkbox"/>	<input checked="" type="checkbox"/>
2	<input checked="" type="checkbox"/>	<input checked="" type="checkbox"/>	<input checked="" type="checkbox"/>	<input checked="" type="checkbox"/>	<input checked="" type="checkbox"/>
3	<input checked="" type="checkbox"/>	<input checked="" type="checkbox"/>	<input checked="" type="checkbox"/>	<input checked="" type="checkbox"/>	<input checked="" type="checkbox"/>
4	<input checked="" type="checkbox"/>	<input checked="" type="checkbox"/>	<input checked="" type="checkbox"/>	<input checked="" type="checkbox"/>	<input checked="" type="checkbox"/>
5	<input checked="" type="checkbox"/>	<input checked="" type="checkbox"/>	<input checked="" type="checkbox"/>	<input checked="" type="checkbox"/>	<input checked="" type="checkbox"/>
6	<input checked="" type="checkbox"/>	<input checked="" type="checkbox"/>	<input checked="" type="checkbox"/>	<input checked="" type="checkbox"/>	<input checked="" type="checkbox"/>
7	<input checked="" type="checkbox"/>	<input checked="" type="checkbox"/>	<input checked="" type="checkbox"/>	<input checked="" type="checkbox"/>	<input checked="" type="checkbox"/>
8	<input checked="" type="checkbox"/>	<input checked="" type="checkbox"/>	<input checked="" type="checkbox"/>	<input checked="" type="checkbox"/>	<input checked="" type="checkbox"/>
9	<input checked="" type="checkbox"/>	<input checked="" type="checkbox"/>	<input checked="" type="checkbox"/>	<input checked="" type="checkbox"/>	<input checked="" type="checkbox"/>
10	<input checked="" type="checkbox"/>	<input checked="" type="checkbox"/>	<input checked="" type="checkbox"/>	<input checked="" type="checkbox"/>	<input checked="" type="checkbox"/>
11	<input checked="" type="checkbox"/>	<input checked="" type="checkbox"/>	<input checked="" type="checkbox"/>	<input checked="" type="checkbox"/>	<input checked="" type="checkbox"/>
12	<input checked="" type="checkbox"/>	<input checked="" type="checkbox"/>	<input checked="" type="checkbox"/>	<input checked="" type="checkbox"/>	<input checked="" type="checkbox"/>
13	<input checked="" type="checkbox"/>	<input checked="" type="checkbox"/>	<input checked="" type="checkbox"/>	<input checked="" type="checkbox"/>	<input checked="" type="checkbox"/>

Hide signals not included in Output settings

Data Sets

Assigned data sets (see " [Data Sets](#)" on page 108) will have an impact on the presence, RF and signals flags. A satellite that is not present in the "Almanac" data set will not be present in the simulation and its row will be disabled.

Settings > GPS						
General						
	Present	RF	C/A	L1C		
Data Sets	All SV ID	<input checked="" type="checkbox"/>	<input checked="" type="checkbox"/>	<input checked="" type="checkbox"/>	<input checked="" type="checkbox"/>	
Message Modification ▶	1	<input checked="" type="checkbox"/>	<input checked="" type="checkbox"/>	<input checked="" type="checkbox"/>	<input checked="" type="checkbox"/>	
Message Sequence ▶	2	<input checked="" type="checkbox"/>	<input checked="" type="checkbox"/>	<input checked="" type="checkbox"/>	<input checked="" type="checkbox"/>	
Pseudorange Offset	3	<input type="checkbox"/>	<input type="checkbox"/>	<input type="checkbox"/>	<input type="checkbox"/>	
Orbits	SV not in Almanac data set	<input type="checkbox"/>	<input type="checkbox"/>	<input type="checkbox"/>	<input type="checkbox"/>	
Perturbations	5	<input checked="" type="checkbox"/>	<input checked="" type="checkbox"/>	<input checked="" type="checkbox"/>	<input checked="" type="checkbox"/>	
Signal Control	6	<input checked="" type="checkbox"/>	<input checked="" type="checkbox"/>	<input checked="" type="checkbox"/>	<input checked="" type="checkbox"/>	
Health	7	<input type="checkbox"/>	<input type="checkbox"/>	<input type="checkbox"/>	<input type="checkbox"/>	
Multipath	8	<input type="checkbox"/>	<input type="checkbox"/>	<input type="checkbox"/>	<input type="checkbox"/>	
Signal Enable/Disable	9	<input type="checkbox"/>	<input type="checkbox"/>	<input type="checkbox"/>	<input type="checkbox"/>	
Transmitted PRN	10	<input type="checkbox"/>	<input type="checkbox"/>	<input type="checkbox"/>	<input type="checkbox"/>	

Furthermore, a satellite that is not present in either of the "Ephemeris" or "Orbit" data sets cannot be simulated and will therefore have its RF and signals flags disabled.

Settings > GPS						
General						
	Present	RF	C/A	L1C		
Data Sets	All SV ID	<input checked="" type="checkbox"/>	<input checked="" type="checkbox"/>	<input checked="" type="checkbox"/>	<input checked="" type="checkbox"/>	
Message Modification ▶	1	<input checked="" type="checkbox"/>	<input checked="" type="checkbox"/>	<input checked="" type="checkbox"/>	<input checked="" type="checkbox"/>	
Message Sequence ▶	2	<input checked="" type="checkbox"/>	<input checked="" type="checkbox"/>	<input checked="" type="checkbox"/>	<input checked="" type="checkbox"/>	
Pseudorange Offset	3	<input checked="" type="checkbox"/>	<input type="checkbox"/>	<input type="checkbox"/>	<input type="checkbox"/>	
Orbits	SV not in Orbit or Ephemeris data set	<input type="checkbox"/>	<input type="checkbox"/>	<input type="checkbox"/>	<input type="checkbox"/>	
Perturbations	5	<input checked="" type="checkbox"/>	<input checked="" type="checkbox"/>	<input checked="" type="checkbox"/>	<input checked="" type="checkbox"/>	
Signal Control	6	<input checked="" type="checkbox"/>	<input checked="" type="checkbox"/>	<input checked="" type="checkbox"/>	<input checked="" type="checkbox"/>	
Health	7	<input checked="" type="checkbox"/>	<input type="checkbox"/>	<input type="checkbox"/>	<input type="checkbox"/>	
Multipath	8	<input checked="" type="checkbox"/>	<input type="checkbox"/>	<input type="checkbox"/>	<input type="checkbox"/>	
Signal Enable/Disable	9	<input checked="" type="checkbox"/>	<input type="checkbox"/>	<input type="checkbox"/>	<input type="checkbox"/>	
Transmitted PRN	10	<input checked="" type="checkbox"/>	<input type="checkbox"/>	<input type="checkbox"/>	<input type="checkbox"/>	

3.12.1.11 Transmitted PRN

The PRN selection settings are located in the **Settings - GPS - Transmitted PRN** menu.

Use these settings to modify which PRN should be transmitted by each satellite for each signal.

You simply have to select a SV ID and click the "Edit PRNs..." button.

SV ID	C/A	L1C	L2C	L5	Modified PRNs
1	3	1	1	1	C/A PRN is set to 3 (default is 1).
2	2	2	2	2	
3	3	3	3	3	
4	37	10	4	4	C/A PRN is set to 37 (default is 4). L1C PRN is set to 10 (default is 4).
5	5	5	5	5	
6	6	6	6	6	
7	7	7	7	7	
8	8	8	8	8	
9	9	9	9	9	
10	10	10	10	10	
11	11	11	11	11	
12	12	12	12	12	
13	13	13	13	13	
14	14	14	14	14	

Hide signals not included in Output settings

  At least one SV is not transmitting default PRN.

You can choose the PRN you want to use for each signal.

Set PRNs transmitted by SV ID 6 ✖

C/A

L1C

L2C

L5

 **Caution:** Some information like the almanac in the navigation messages are provided for each PRN. Skydel will use the SV ID with the



appropriate PRN to build the navigation message, but if you assign the same PRN to multiple satellites, Skydel will choose one arbitrarily.

In most settings page where information is shown for one satellite at the time, such as the orbital settings page, the PRN value is displayed along with the SV ID. If the satellite uses more than one PRN, Skydel will display a more detailed list.

◀ **Settings** ▶ SBAS

General	SV ID <input type="text" value="3"/>	PRN: 122
Message sequence	Clock Bias a_{GF0} <input type="text" value="0.000000"/> ns	
Pseudorange Offset	Relative Frequency Bias a_{GF1} <input type="text" value="0.000000"/> ppb	
Motion	X_G <input type="text" value="-33893.92800"/> km	
Health		

Figure 3-17: Simplified version when a satellite uses only one PRN.

◀ **Settings** ▶ GPS

General	SV ID <input type="text" value="4"/>	PRN: C/A → 37	L1C → 10	L2C → 4	L1 P-Code → 4	L2 P-Code → 4	L1 M-Code → 4	L2 M-Code → 4	L5 → 4
Data Sets									
Message Modification ▶	Reference time (GPS)	<input type="text" value="2021-06-24 12:00:00"/>							
Message Sequence ▶	Root semi major axis	\sqrt{A}	<input type="text" value="5153.71612549"/>	$m^{\frac{1}{2}}$					
Pseudorange Offset	Eccentricity	ϵ	<input type="text" value="0.00127391889691"/>						
Orbits	Argument of perigee	ω	<input type="text" value="-0.93509311787771"/>	semicircle					

Figure 3-18: Detailed version when a satellite uses multiple PRN values.

3.12.1.12 Filter Assignment

The Filter Assignment settings are located in the **Settings - GPS - Filter Assignment** menu.

In this menu, you can assign filters to signals. A filter will affect the signal at the digital IQ level, before the IQ data is sent to the SDR.

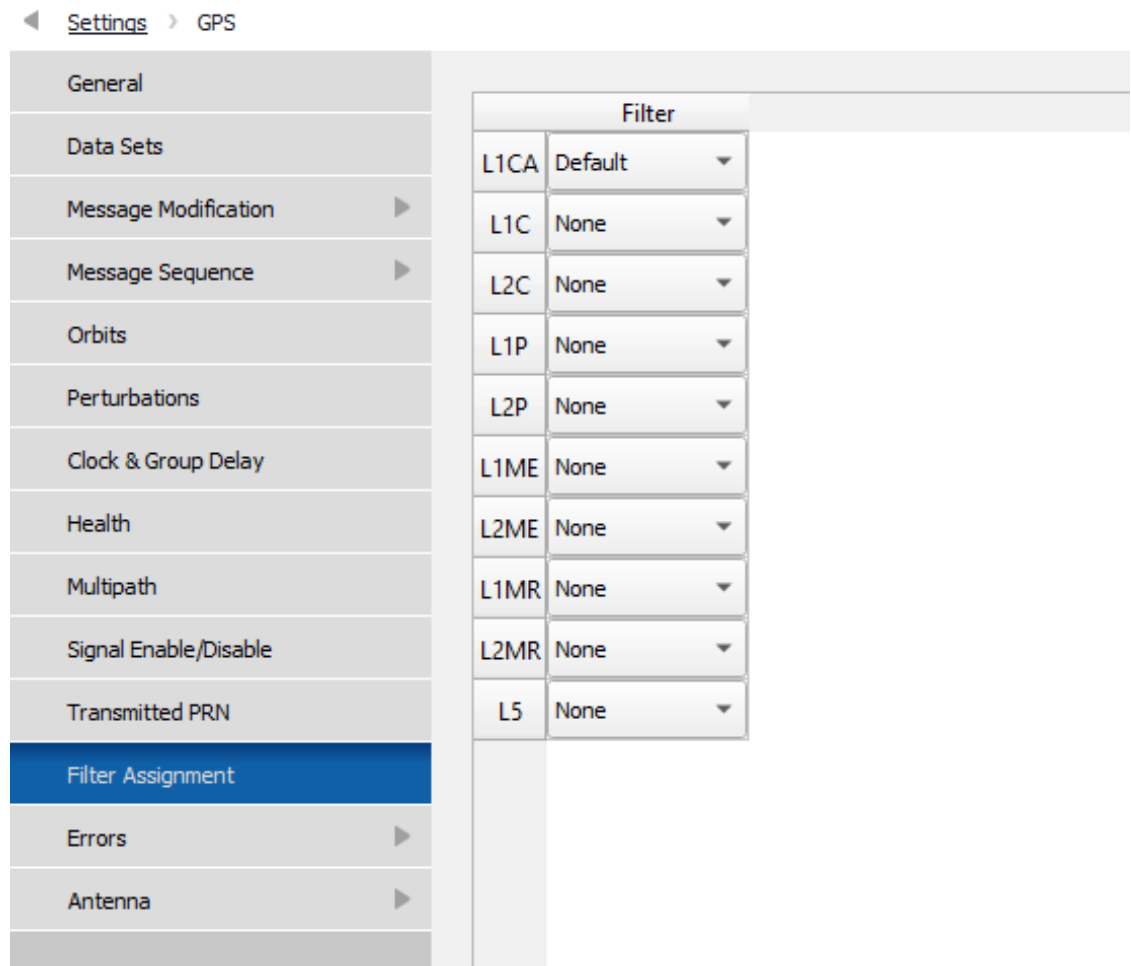

The two default filter choices are:

- » None: No filter will be applied to this signal (default option)
- » Default: The default filter will be applied to this signal

The Default filter is a basic low-pass FIR filter of order 99. It is centered around the signal's central frequency with a cutoff frequency matching half of the signal's bandwidth referenced in the ICD for that signal. When used, the filtered signal will appear with a narrower bandwidth in the Spectrum.

When using the Default filter on a signal that is selected in an output, certain restrictions apply to the sampling rate of that output. If the sampling rate of that output is too high or too low to filter this signal, a warning will appear in the Status Log at the start of the simulation and the filter will be disabled. To enable the filter, the output's sampling rate must be modified accordingly.

3.12.1.13 Errors

The Errors settings are located in the **Settings - GPS - Errors** menu.

The Errors menu contains three submenus:

- » Pseudorange Offset
- » Pseudorange Errors
- » Ephemeris Errors

Pseudorange Offset

In this submenu, you can create biases and ramps on the pseudoranges being simulated. These offsets, like "[Pseudorange Errors](#)" on the facing page, can be compensated in the SBAS **fast correction** messages (Messages 2-5), see "[Manual Message Sequence](#)" on page 153.

When you add an offset to a pseudorange, the simulated signal will appear to arrive earlier or later than it normally would. You may use offsets to simulate effects like:

- » clock errors;
- » atmospheric errors;
- » satellite errors;
- » inter-channel bias;
- » spoofing (see also "[Advanced Spoofing](#)" on page 202).

Pseudorange offsets can be applied to all SV IDs or to a specific SV ID. You may also have multiple offsets in effect at the same time. Skydel will add each of the offsets together to determine the appropriate total offset at any given time. This is very convenient when trying to simulate complex scenarios such as a receiver clock error ramp (which affects all SV IDs) occurring at the same time as a SV that has a bias in its transmitted signal.

To create a Pseudorange Offset, click the Add button.

Below is an example of creating a pseudorange offset that only affects SV ID 4. Starting at fifteen minutes into the simulation, the offset ramps up to 1 meter over the course of 45 minutes. The offset then stays at 1 meter for 30 minutes, and finally ramps down to zero over the course of another 30 minutes. The entire event will last 2 hours. Checking the Stop box is necessary to enable the Stop field.

Add Pseudorange Offset
✕

SV ID

Offset

Start

Hold Start

Hold Stop

Stop

Add

✕ Close

When you are finished creating the pseudorange offset, click the Add button. This will add the offset to the list. The “Add Pseudorange Offset” dialog box will stay open so that you can quickly add several offsets. When you are finished adding offsets, you can close the dialog box.

	Start	Hold Start	Hold Stop	Stop	SV ID	Offset (m)
1	0:15:00	1:00:00	1:30:00	2:00:00	4	1

To edit a pseudorange offset, simply select the desired line in the list and click on the Edit button.

Pseudorange Errors

In this submenu, you can inject an error on the pseudorange of each satellite by enabling functions such as Gauss-Markov, Sine Waves and Offset. These errors, like " [Pseudorange Offset](#)" on the previous page, can be compensated in the SBAS **fast correction** messages (Messages 2-5), see "[Manual Message Sequence](#)" on page 153.

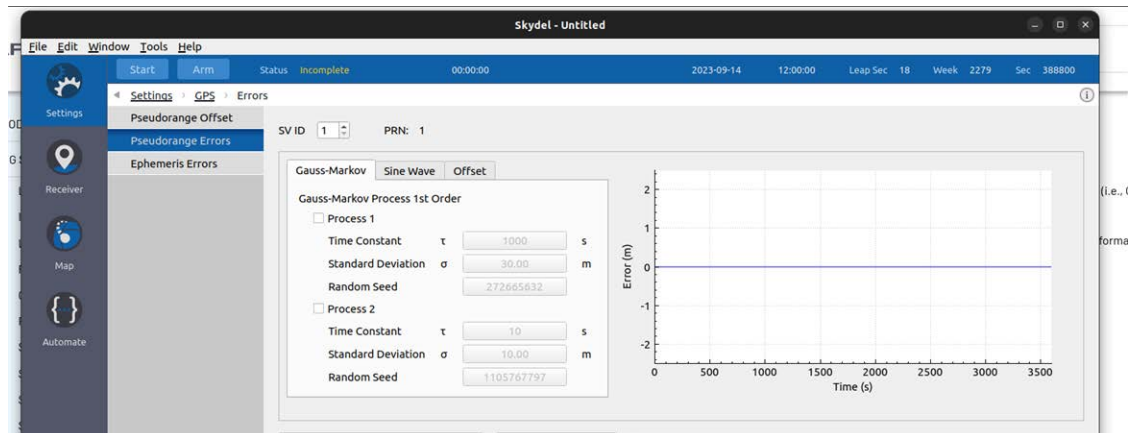

Figure 3-19: Pseudorange Errors (Gauss-Markov function)

Ephemeris Errors

In this submenu, you can inject track errors and clock errors on each satellite. These errors can be compensated in the SBAS **long term correction** messages (Message 25), see ["Manual Message Sequence" on page 153](#).

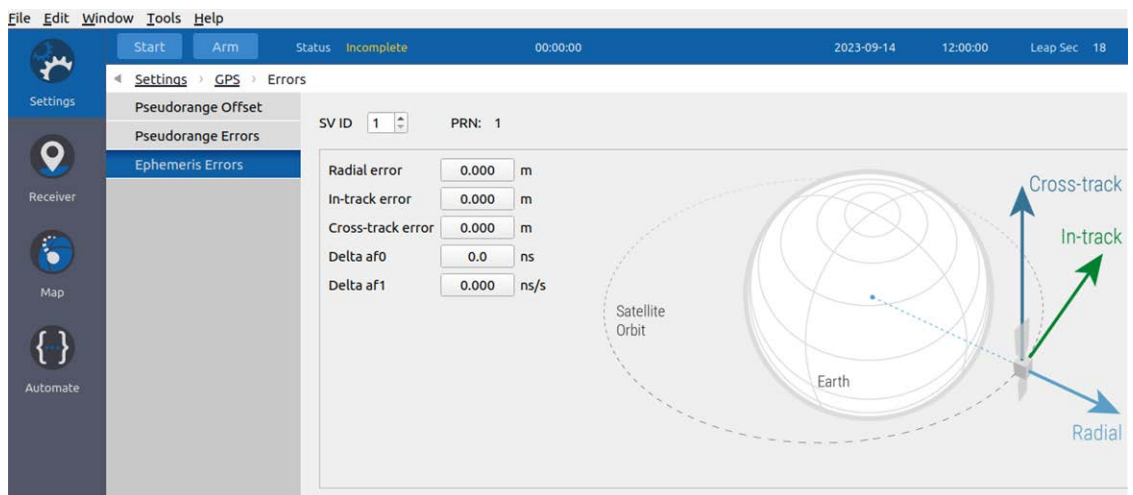

Figure 3-20: Ephemeris Errors



Note: SBAS corrections for Pseudorange Errors and Ephemeris Errors are enabled by default for each satellite.

3.12.1.14 Antenna

The Antenna settings are located in the **Settings - GPS - Antenna** menu.

You can use the Antenna settings to change how the satellite's antenna is modeled. Changing the antenna model will affect the power and phase offset of the transmitted signals. Phase offsets are expressed in angles.



Note: This section refers to parameters pertaining to the **GNSS satellite's antenna** (transmitter). For the vehicle antenna (receiver), refer to section Vehicle Antenna.

Models

In this submenu, you can manage the antenna models you will use for the space vehicles. You can use a different antenna gain and phase offset patterns for each band and also add an offset in gain patterns. The Basic Antenna is used by default. It can be changed but cannot be removed.

Skydel includes additional basic antenna gain patterns. They can be found in the "Skydel-SDX/Templates/Antennas" folder in Documents.

In this folder, you will find five basic antenna models:

- » Cardoid
- » GPS703GGG
- » Helix
- » Patch
- » Zero

For each of these antenna models, two files can be found:

- » An antenna pattern file (.csv) which can be imported individually for a band on a custom antenna model via the "More..." button.
- » An antenna model file (.xml) which includes the associated antenna pattern file on all bands. This model can be imported via the "Import..." button.

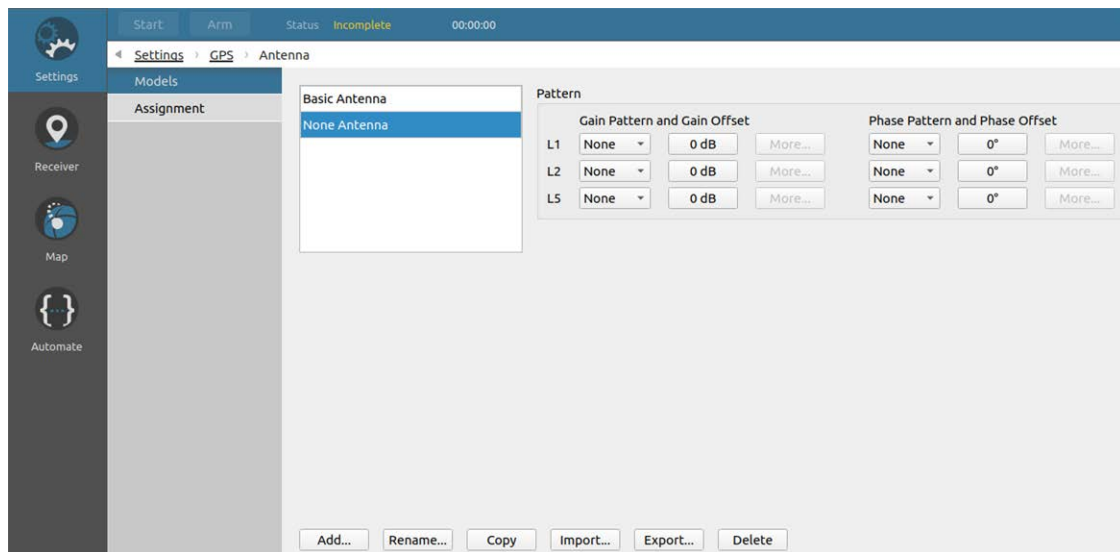

Figure 3-21: Antenna Model submenu

The Models screen allows you to:

- » add a new model
- » rename a model from the list
- » copy (duplicate) an existing model
- » import a model (file)
- » export a model (file)
- » delete a model

When selected, review and modify a model's patterns (right pane).

A **Basic Antenna** model is always present in the list. You can edit or copy it, but it cannot be deleted or renamed.

Adding a model will create a new "blank" antenna model.

Importing a model will enable you to reuse a model that was exported from another Skydel configuration through the export button. Exported models are saved on the computer as a model definition file.

For each model, the following pattern choices are available:

- » default (patch antenna)
- » none (isotropic)
- » custom

For gain and phase patterns, you can add an offset.

Pattern

	Gain Pattern and Gain Offset			Phase Pattern and Phase Offset		
L1	None ▾	0 dB	More...	None ▾	0°	More...
L2	None ▾	0 dB	More...	None ▾	0°	More...
L5	None ▾	0 dB	More...	None ▾	0°	More...

Clicking the “More” button for a band gain or phase offset brings up a depiction of the antenna model pattern and allows you to import a new pattern from a CSV file.

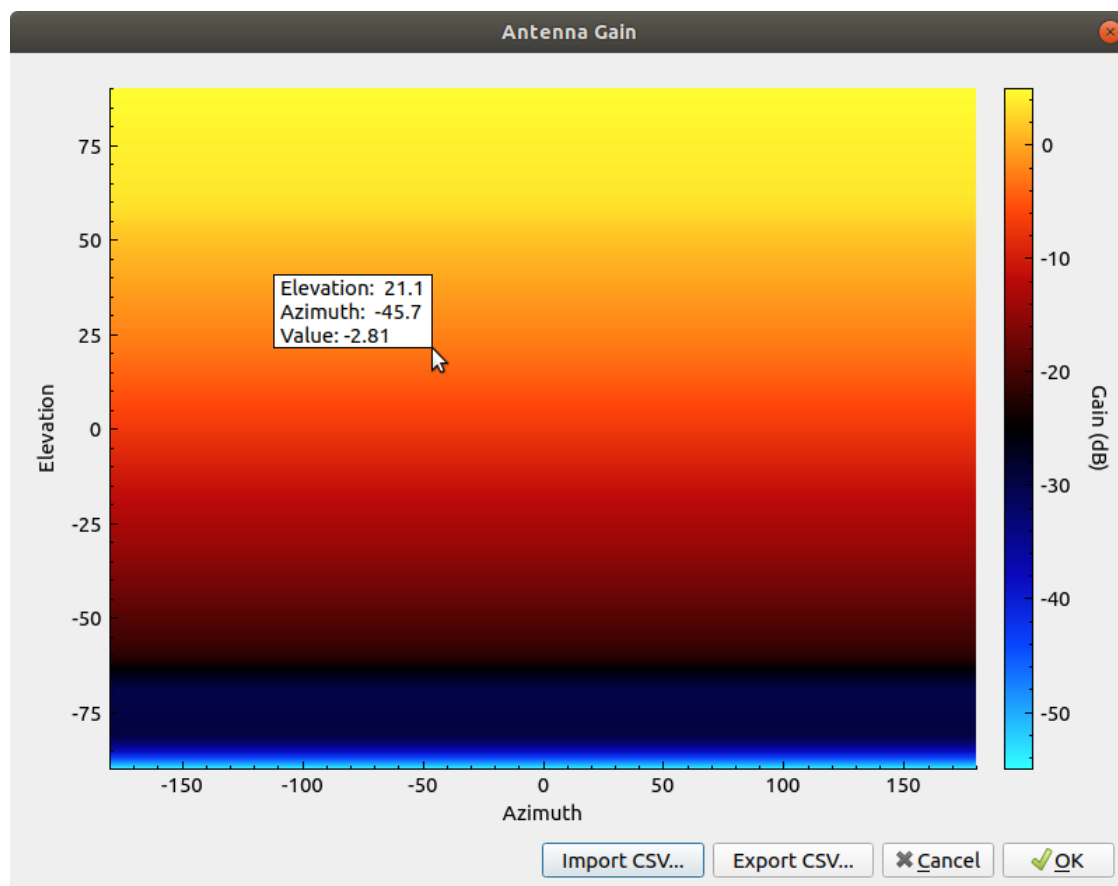

The 3D model is illustrated in two dimensions using a graph displaying the gain values with a color gradient, and their position in 3D space using the horizontal coordinate system. The graph axis represent the azimuth (x axis, from -180° to 180°) and the elevation (y axis: -90° to 90°).

You can export the antenna gain pattern to a CSV file, modify it, and import it back into Skydel. CSV files are formatted as follows:

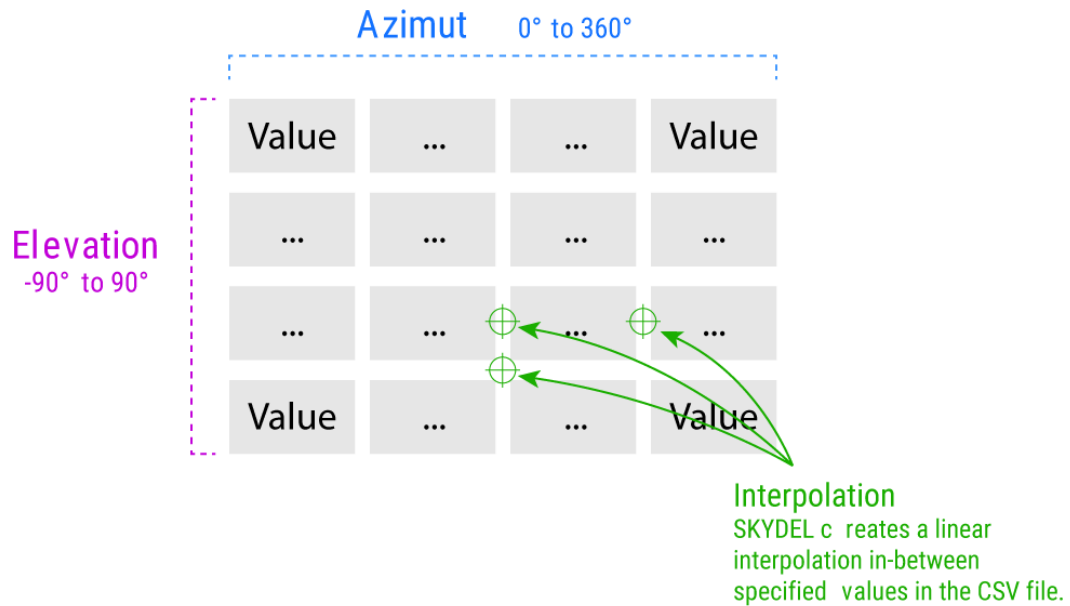

- » Each file is a matrix of values (either gain or phase offset). Skydel will automatically create a linear interpolation between each specified value to create a continuous 3D pattern.
- » Values are dB for gain and radians or degrees for phase offset.
- » Rows represents the elevation range of $[-90^\circ, 90^\circ]$ from top to bottom and columns represents azimuth range of $[0^\circ, 360^\circ]$ from left to right.
- » The first row always represents an elevation of -90° .
- » The last row always represents an elevation of 90° .
- » Every row positioned in between will partition the elevation pattern.
- » The first column always represents an azimuth of 0° .
- » Every additional column will partition the 360° azimuth range into smaller range of equal size.

For example, in the following file:

```
1, 2, 3
4, 5, 6
7, 8, 9
```

- » There are 3 columns. Therefore, the azimuth step size is 120° ($360^\circ / \text{NbCols}$). The first column is for azimuth 0° , second for azimuth 120° and last column is for -120° . At 180° , the pattern loops back to -180° .
- » There are 3 rows. Therefore, the elevation step size is 90° ($180^\circ / (\text{NbRows} - 1)$). The first row is for elevation -90° , second row for elevation 0° and last row is for 90° .

The default pattern for satellites contains 901 lines: elevation step is 0.2° and azimuth is always the same.

Assignment

Use this screen to assign antenna models to space vehicle. To assign a model, select one or multiple SV IDs in the list, then the model desired, and finally click the Assign to Selection button.

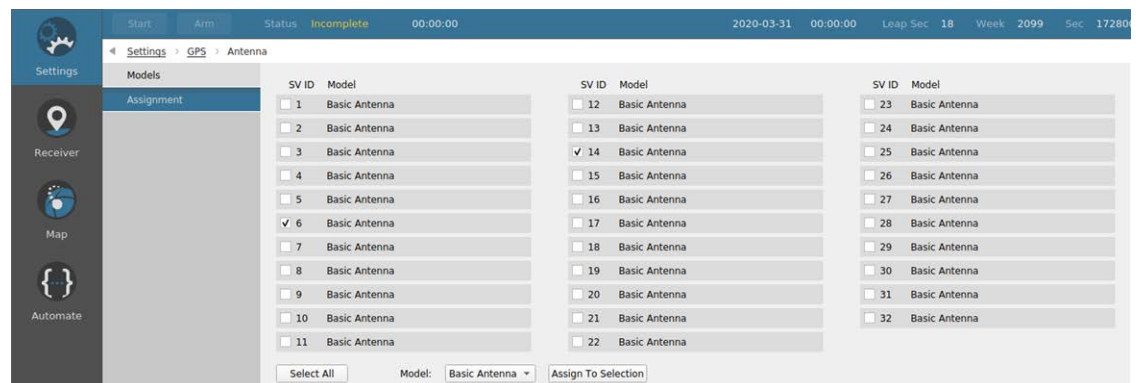

Figure 3-22: Antenna Assignment submenu

3.12.2 GLONASS

The GLONASS settings are located in the **Settings - GLONASS** sub-menu.

The GLONASS settings control the orbits, downlink data, and signals of the GLONASS satellites. These settings have no effect on the other constellations (i.e., GPS, Galileo, BeiDou, SBAS, QZSS and NavIC).

The GLONASS settings are nearly identical in operation to the GPS settings. with the exception of Data sets. Refer to the "[GPS](#)" on page 106 settings section for more information. Only the specifics of GLONASS will be described in this section.

3.12.2.1 General

The General settings are located in the **Settings - GLONASS - General** menu.

To import a RINEX navigation file, click the Select button in the General settings screen.

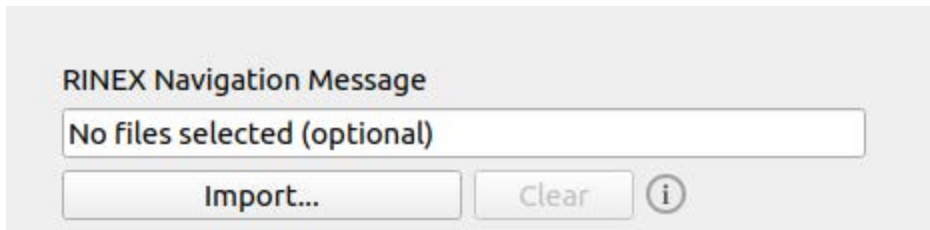

Skydel will ask you to provide a RINEX-compatible navigation file. Sample files are located in “Skydel-SDX/Templates”. Importing a RINEX file will override each of the current Orbits, Perturbations, and Clock settings.

When importing the RINEX navigation file, Skydel will compare the leap second from the RINEX and the leap second defined in ["Settings: Start Time" on page 73](#). If the values mismatch, Skydel will display this warning:

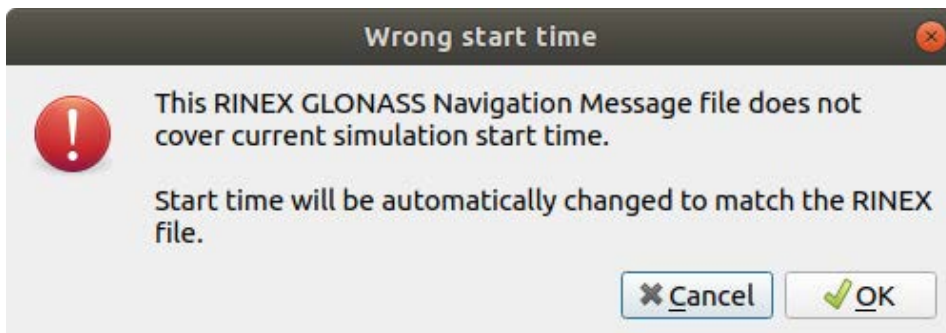

GLONASS is particularly sensitive to leap second errors because its reference time is attached to the UTC time.

The GLONASS RINEX navigation file does not define orbits using Keplerian elements. Instead it provides absolute positions which must be interpolated. These positions are only valid for the given RINEX observation time and can't be easily extrapolated in the past or future. Therefore, when you import a RINEX navigation file, you must set the simulation in ["Settings: Start Time" on page 73](#) to the same day as the imported RINEX file.

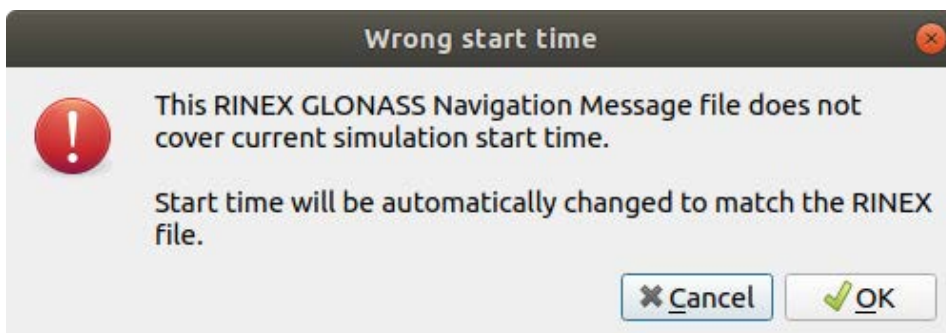

3.12.2.2 Leap Seconds

Unlike other constellations, GLONASS system time is relative to UTC time. Whenever a leap second is added (or subtracted), it directly affects the GLONASS system time. When a second is added, it always occurs at the end of a quarter at midnight UTC. The following image illustrates how Skydel realigns the next subframe with the new UTC time after the leap second event.

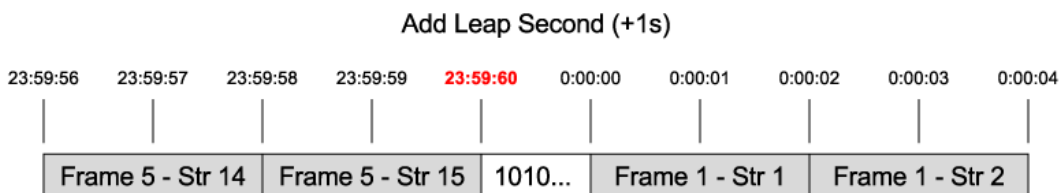

When a second is subtracted, the behaviour is similar, but the first transmitted string after the event is String #2.

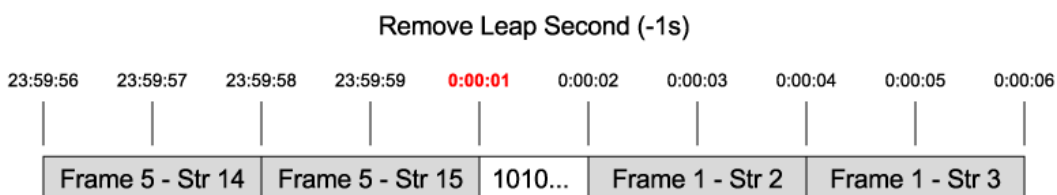

Leap seconds future event is configured in ["Settings: Start Time"](#) on page 73.

3.12.3 GALILEO

The Galileo settings are located in the **Settings - GALILEO** sub-menu.

The Galileo settings control the orbits, downlink data, and signals of the Galileo satellites. These settings have no effect on the other constellations (i.e., GPS, GLONASS, BeiDou, SBAS, QZSS and NavIC).

The Galileo settings are nearly identical in operation to the GPS settings. Refer to the ["GPS" on page 106](#) settings section for more information. Only the specifics of Galileo will be described in this section.

3.12.3.1 F/NAV Source Diversity

The F/NAV Source Diversity settings are located in the **Settings - GALILEO - F/NAV Source Diversity** menu.

Satellites		
1	PRN k=1	▲▼
2	PRN k=4	▲▼
3	PRN k=7	▲▼
4	PRN k=10	▲▼
5	PRN k=13	▲▼
6	PRN k=16	▲▼
7	PRN k=19	▲▼
8	PRN k=22	▲▼
9	PRN k=25	▲▼
10	PRN k=28	▲▼
11	PRN k=31	▲▼
12	PRN k=34	▲▼
13	PRN k=1	▲▼

Each satellite will transmit almanac for 36 satellites starting with PRN k.

You can use the F/NAV Source Diversity settings to control which almanacs will be broadcast first for each satellite. In the F/NAV navigation message plan, each Galileo satellite can start broadcasting the almanac with an offset for the PRN value. This offset is known as the k parameter in the Galileo ICD. It is set for each of the active satellites, and enables improvements to almanac transport time by exploiting source diversity.

3.12.3.2 OSNMA

The OSNMA settings are located in the **Settings - GALILEO - OSNMA** menu.

The Settings - GALILEO - OSNMA menu is composed of 3 sub-menus:

- » General
- » SV Providers
- » Merkle Trees

General

The General page allows the configuration of OSNMA TESLA Chain parameters.

◀ [Settings](#) > [GALILEO](#) > OSNMA

General	Tag Size (bits)	40	▼
SV Providers	Key Size (bits)	128	▼
Merkle Trees	Hash Function	SHA-256	▼
	MAC Function	HMAC-SHA-256	▼
	MAC Look-up Table ID	33	▼ ⓘ

SV Providers

The SV Providers page allows the selection of the Galileo satellites which will provide the OSNMA service. Each satellite providing the service authenticates a set of satellites. This set can be manually configured using the `CrossAuthenticatedSatellitesForSV` command. If no satellites are manually configured, or if an empty list is provided, the cross-authenticated satellites included in the MAC sequences will default to those closest to the satellite providing the OSNMA service.

Settings > GALILEO > OSNMA

General

SV Providers

Merkle Trees

OSNMA Enabled	
All SV ID	<input checked="" type="checkbox"/>
1	<input type="checkbox"/>
2	<input type="checkbox"/>
3	<input checked="" type="checkbox"/>
4	<input type="checkbox"/>
5	<input checked="" type="checkbox"/>
6	<input type="checkbox"/>
7	<input checked="" type="checkbox"/>
8	<input checked="" type="checkbox"/>
9	<input type="checkbox"/>
10	<input checked="" type="checkbox"/>

Merkle Trees

The Merkle Trees page allows the generation of OSNMA Merkle Trees with the desired parameters.

Settings > GALILEO > OSNMA

General

SV Providers

Merkle Trees

Unique IDs

MT-D97F6FE86186460F824F94C1124C4FB3

Public Keys Type ECDSA P-256/SHA-256 ▾

Hash Function SHA-256 ▾

Applicability Begin Date 2023-09-14 12:00:00

Applicability End Date 2023-09-14 12:00:00

Merkle Tree Root

DB813AF0EA305CA32E9C2E93E4... [🔗](#)

Add
Remove
Export...

The Export button exports the selected OSNMA Merkle Tree with the first OSNMA Public Key ($i = 0$) to an XML file with format defined in the Galileo OSNMA IDD ICD v1.1.

The OSNMA Merkle Tree selected for the simulation is the first (from top to bottom) with a begin date earlier than the simulation start date and with an end date not outdated by the simulation start date.

The OSNMA Public Key selected for the simulation is always the first key in the applicable OSNMA Merkle Tree, the one with $i = 0$ and $PKID = 1$.

If there is no applicable cryptographic material during the simulation, then OSNMA will be not provided.

3.12.3.3 Inter-Modulation

The Inter-Modulation settings are located in the Settings - GALILEO - Inter-Modulation menu.

This page allow users to generate a new Galileo E1 signal with multiple elements.

The new signal equation is as follows:

$$s(t) = A * sE1B(t) + B * sE1C(t) + j (C * sE1PRS(t) + D * sE1IM(t))$$

For more explanation about the s term, see Galileo SIS ICD v2.1, 2.3 Modulation

E1 IM represents a signal inter-modulated with signal equation : $sE1IM(t) = sE1PRS(t) * sE1B(t) * sE1C(t)$

The four coefficients A, B, C and D are configurable in the Settings page:

E1_{IM}	<input type="text" value="0.00000"/>
E1_b	<input type="text" value="1.00000"/>
E1_c	<input type="text" value="1.00000"/>
E1 PRS	<input type="text" value="1.00000"/>

The image above shows the default coefficients, if one of those coefficients is modified, the Galileo E1 Multi-Element signal will be generated if Galileo E1 and Galileo E1 PRS are present in the output. The Galileo E1 Multi-Element and the Galileo E1 IM signals are not present in the spectrum.

Generating the Galileo E1 Multi-Element signal may cause a reduction in performance.

3.12.4 BEIDOU

The BeiDou settings are located in the **Settings - BEIDOU** sub-menu.

The BeiDou settings control the orbits, downlink data, and signals of the BeiDou satellites. These settings have no effect on the other constellations (i.e., GPS, GLONASS, Galileo, SBAS, QZSS and NavIC).

The BeiDou settings are nearly identical in operation to the GPS settings. Refer to the "[GPS](#)" on [page 106](#) settings section for more information.

3.12.5 QZSS

The QZSS settings are located in the **Settings - QZSS** sub-menu.

The QZSS settings control the orbits, downlink data, and signals of the QZSS satellites. These settings have no effect on the other constellations (i.e., GPS, GLONASS, Galileo, SBAS, BeiDou and NavIC).

The QZSS settings are nearly identical in operation to the GPS settings. Refer to the "[GPS](#)" on [page 106](#) settings section for more information. Only QZSS-specific information will be described in this section.

3.12.5.1 L1S augmentations

The L1S augmentations settings are located in the **Settings - QZSS - L1S augmentations** menu.

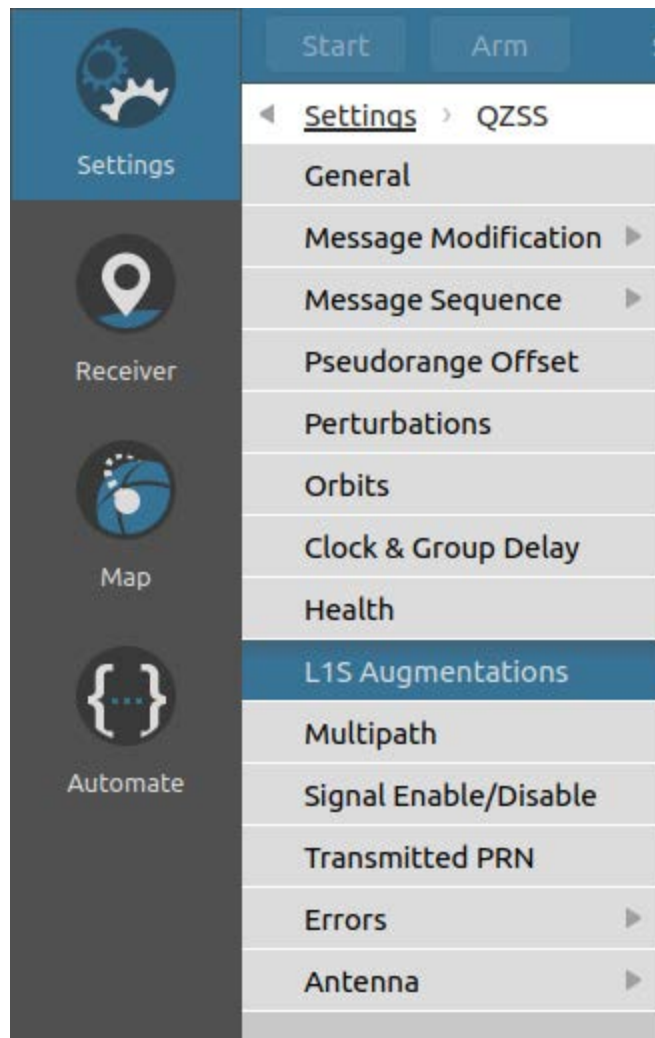

The L1S augmentations page allows to set augmentations which will be used to fill the QZSS L1S navigation message.

Add L1S Augmentation
✕

Augmentation

Constellation GPS ▾

PRN 1 ▾

Augment IOD

Augment PRC

PRC 0.00

Add
✕ Close

The Add button will add the L1S augmentation to the list. The dialog box will stay open so that you may easily add a similar L1S augmentation. When you are done creating augmentations, close the dialog box.



Caution: Only one augmentation per PRN of each constellation is allowed, as well as a maximum of 23 augmentations in total.

	Constellation	PRN	Augment IOD	Augment PRC	PRC
1	GPS	1	False	False	0

To edit an augmentation, simply select the desired line in the list and click on the Edit button.

3.12.5.2 QZSS L6

The QZSS L6 signal is available in Skydel.

Please note that only the L6D portion of the signal (the CLAS messages) is broadcast. The content of the L6E portion should not be used.

3.12.6 NavIC

The NavIC settings are located in the **Settings - NAVIC** sub-menu.

The NavIC settings control the orbits, downlink data, and signals of the NavIC satellites. These settings have no effect on the other constellations (i.e., GPS, GLONASS, Galileo, SBAS, BeiDou and QZSS).

The NavIC settings are nearly identical in operation to the GPS settings. Refer to the "[GPS](#)" on page 106 settings section for more information.

3.12.7 SBAS

The SBAS settings are located in the **Settings - SBAS** sub-menu.

SBAS settings control the orbits, downlink data, and signals of the SBAS satellites. These settings have no effect on other constellations (i.e., GPS, GLONASS, Galileo, BeiDou, QZSS and NavIC).

The SBAS settings are very similar in operation to the GPS settings. Refer to the "[GPS](#)" on page 106 settings section for more information. Only SBAS-specific information will be described in this section.

3.12.7.1 General

The General settings are located in the **Settings - SBAS - General** menu.

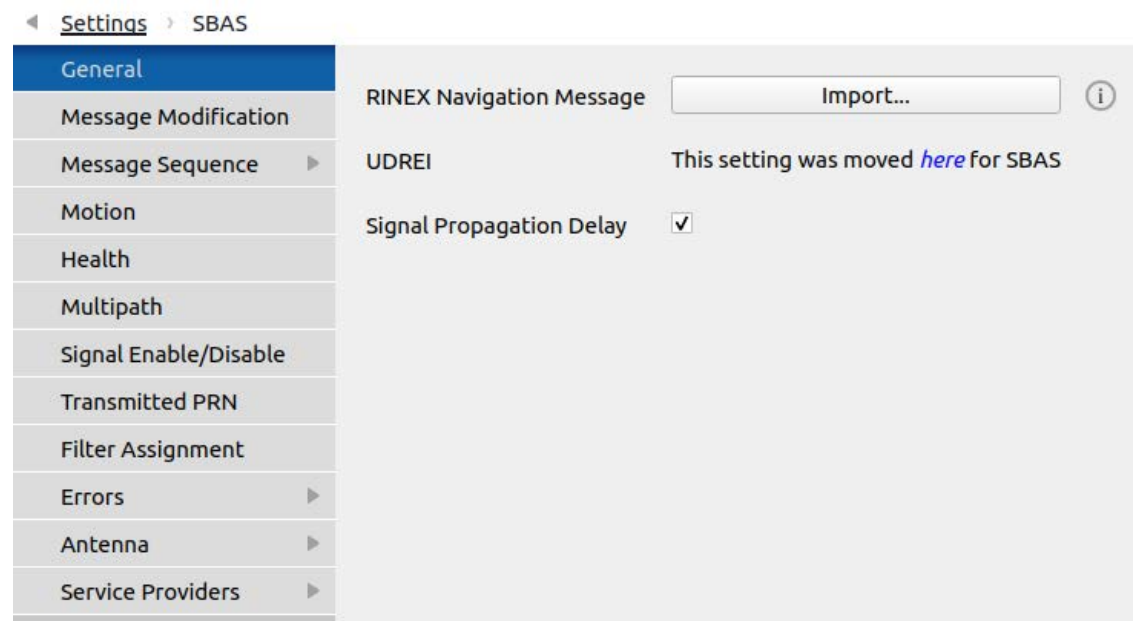

The current Skydel version supports fast corrections for GPS and SBAS and long term corrections for GPS only.

3.12.7.2 Manual Message Sequence

The Manual Message Sequence settings are located in the **Settings - SBAS - Message Sequence - Manual** menu.

This menu allows to configure a custom message sequence for each signal.

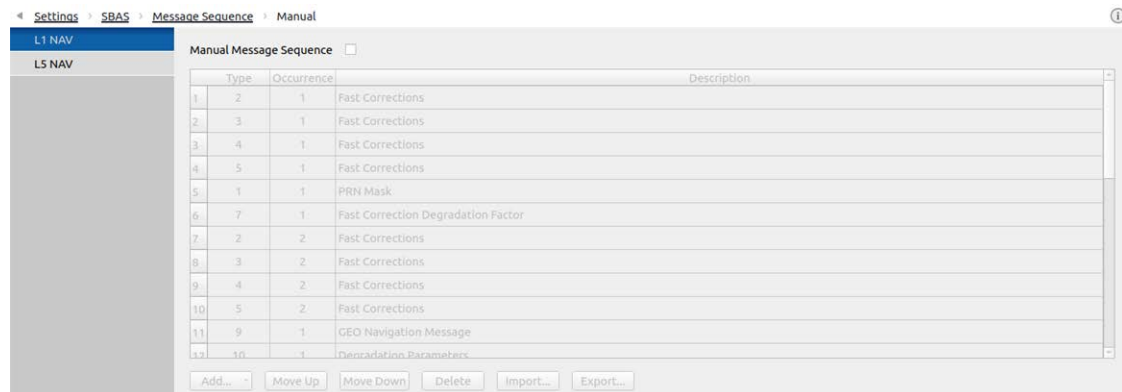

When the Manual Message Sequence option is enabled, the defined sequence will be used as is during the simulation. You can edit the message sequence here, and even export it. Once the sequence reaches its end during the simulation, it will simply loop and start over.



Note: It is recommended to use the "Automatic Message Sequence" on page 156 rather than the Manual configuration. The Manual configuration has certain limitations and cannot guarantee the integrity of the data in the navigation message. Use this method of configuring the message sequence only when you need to replicate an exact sequence, such as when reproducing live sky conditions or specific scenarios.

3.12.7.3 Health

The Health settings are located in the **Settings - SBAS - Health** menu.

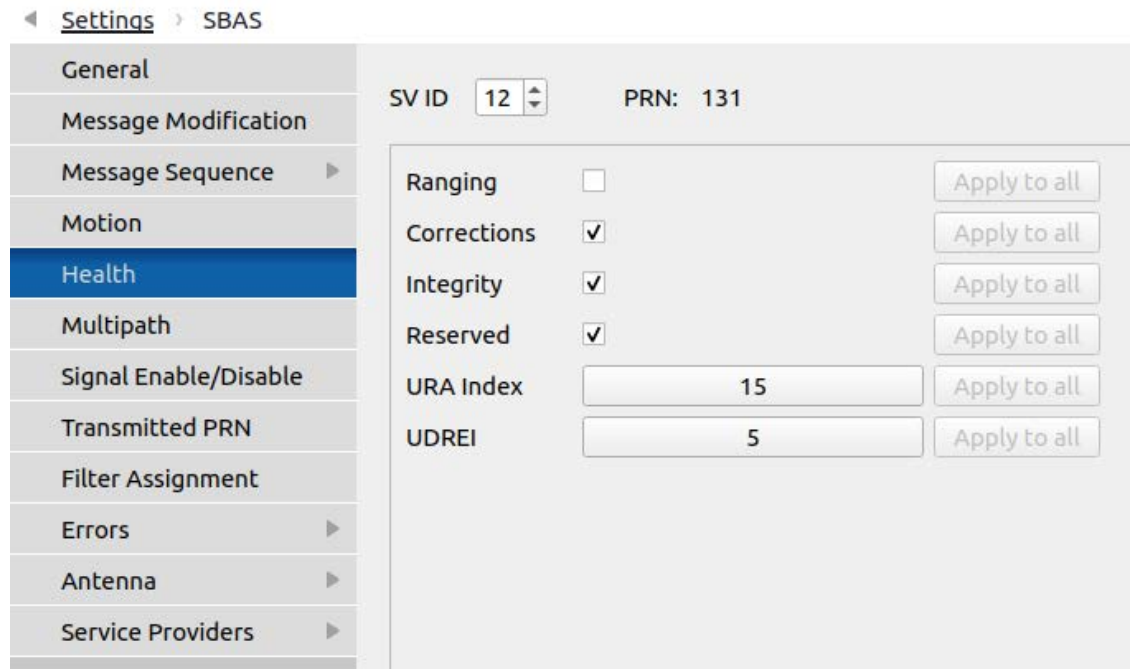

When a check box is checked, it means **On**. For example, if the Ranging is checked, the Ranging is On which means the corresponding bit in the navigation message is set to zero.

Use the Apply-to-all button to apply a health parameter to all the satellites.

By default, ranging is disabled in both the Health and URA Index fields when importing a RINEX file, since SBAS satellites are generally not intended for ranging applications. Enabling ranging on SBAS satellites may degrade receiver performance, so proceed at your own risk.

3.12.7.4 Service Providers Assignment

The Service Providers Assignment settings are located in the **Settings - SBAS - Service Providers - Assignment** menu.

◀ Settings > SBAS > Service Providers

Assignment	SV ID	SV ID	SV ID	SV ID
WAAS ▶	1 SBAS ▼	11 SBAS ▼	21 SDCM ▼	31 EGNOS ▼
EGNOS ▶	2 EGNOS ▼	12 WAAS ▼	22 SDCM ▼	32 SBAS ▼
MSAS ▶	3 SBAS ▼	13 GAGAN ▼	23 SBAS ▼	33 SBAS ▼
GAGAN ▶	4 EGNOS ▼	14 WAAS ▼	24 SBAS ▼	34 SBAS ▼
SDCM ▶	5 SBAS ▼	15 SBAS ▼	25 SBAS ▼	35 SBAS ▼
	6 SDCM ▼	16 WAAS ▼	26 SBAS ▼	36 SBAS ▼
	7 SBAS ▼	17 EGNOS ▼	27 SBAS ▼	37 SBAS ▼
	8 GAGAN ▼	18 MSAS ▼	28 SBAS ▼	38 SBAS ▼
	9 GAGAN ▼	19 SBAS ▼	29 SBAS ▼	39 SBAS ▼
	10 MSAS ▼	20 MSAS ▼	30 SBAS ▼	

The service provider indicates the SBAS constellation to which a satellite is assigned—WAAS (0), EGNOS (1), MSAS (2), and so on. Currently supported SBAS constellations include: WAAS, EGNOS, MSAS, GAGAN, SDCM, BDSBAS, and KASS. The default service provider assignments is based on the [L1 C/A PRN Code Assignments - April 2023](#)

If a satellite belongs to an unsupported constellation, is reserved, or remains unallocated, it is simply labeled as SBAS.

When importing a RINEX navigation file, the default service provider assignments may not be accurate. If needed, you can manually adjust the assignments using this menu.

In the Signal Power settings, you can also configure the power offset for each service provider.

3.12.7.5 Automatic Message Sequence

The Message Sequence by Service Provider settings are located in the **Settings - SBAS - Service Providers - ServiceProvider - Message Sequence** menu.

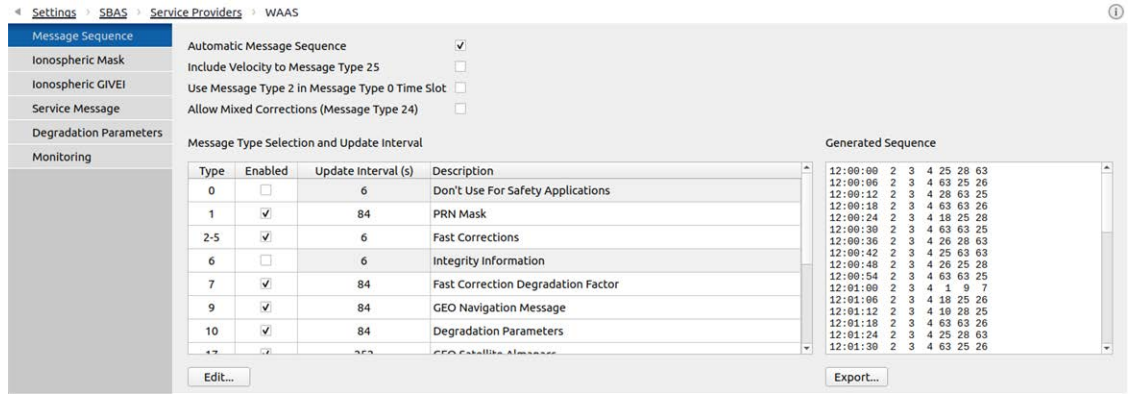

The menu specifies the type of message sequence —Manual or Automatic— to be used for all SBAS signals throughout the simulation.

It also includes global configuration options that apply to both types of message sequences, such as whether to include velocity in message type 25.

It is also possible to configure whether Skydel should attempt to replace a fast correction message (message types 2, 3, 4 and 5) with a mixed correction message (message type 24) when applicable.

For the Message Sequence configuration, each message type has the same 1-second duration. The message sequence changes according to the maximum update interval for each message type.

By default, fast corrections have a maximum update interval of 6 seconds and the other message types have longer intervals such as 84 seconds or 252 seconds.

The generated message sequence starts at 12:00:00, is unique and of length defined by the the lowest common multiple of all different update intervals, to a limit of 7200 messages. An offset is applied to the sequence starting index depending on the simulation start time.

With regard to fast corrections, message type 2 will transmit data sets for the first 13 satellites designated in the PRN mask. Message type 3 contains data sets for the following 13 satellites, and so on. If, for example, there are data sets for only 37 satellites to transmit, message types 2, 3 and 4 will be transmitted, but not message type 5 (it's not needed since data sets are all empty). In this case, the fast corrections message sequence will be 2, 3, 4, 2, 3, 4, 2, 3, 4. This means we can insert 3 other message types before rolling back to fast correction messages.

The delays given in the message 26 consist of the addition of the delays from the current ionospheric model in Settings - Global - Atmosphere - Nominal and the offsets provided in Settings - Global - Atmosphere - " Errors" on page 81 (if enabled).

3.12.7.6 Ionospheric Masks

The Ionospheric Masks settings are located in the **Settings - SBAS - Service Providers - ServiceProvider - Ionospheric masks** menu.

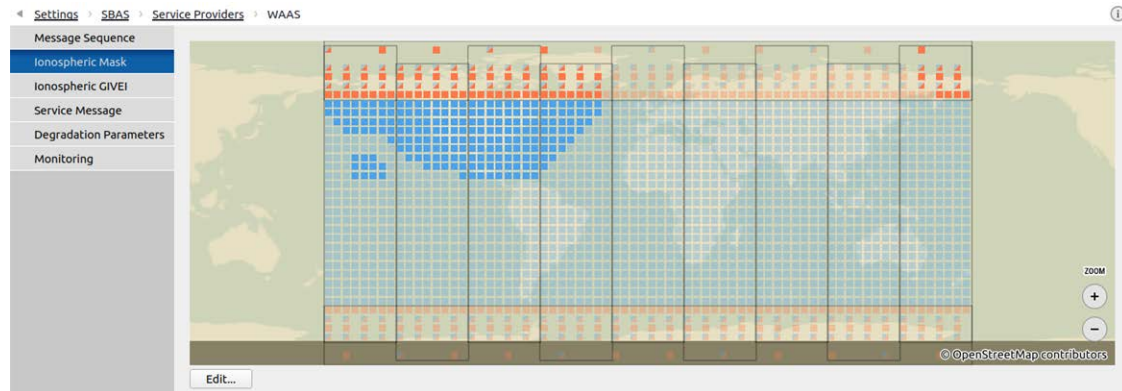

This panel describes the content of the SBAS message 18 (see ["Manual Message Sequence" on page 153](#)) as an ionospheric grid, where each IGP tells if the position is monitored by the SBAS satellite of the service provider.

Information about the highlighted IGP (latitude, longitude, flag(s)) is shown below the map. As some IGP from different bands are located at the same coordinates, it is sometimes normal to have different flags for the same position on the map. The points are either blue (band 0 to 8) or orange (bands 9 and 10). Points present on two bands at once are illustrated with two colored triangles.

You can edit the map by clicking the Edit button. This will open a dialog containing an editable map.

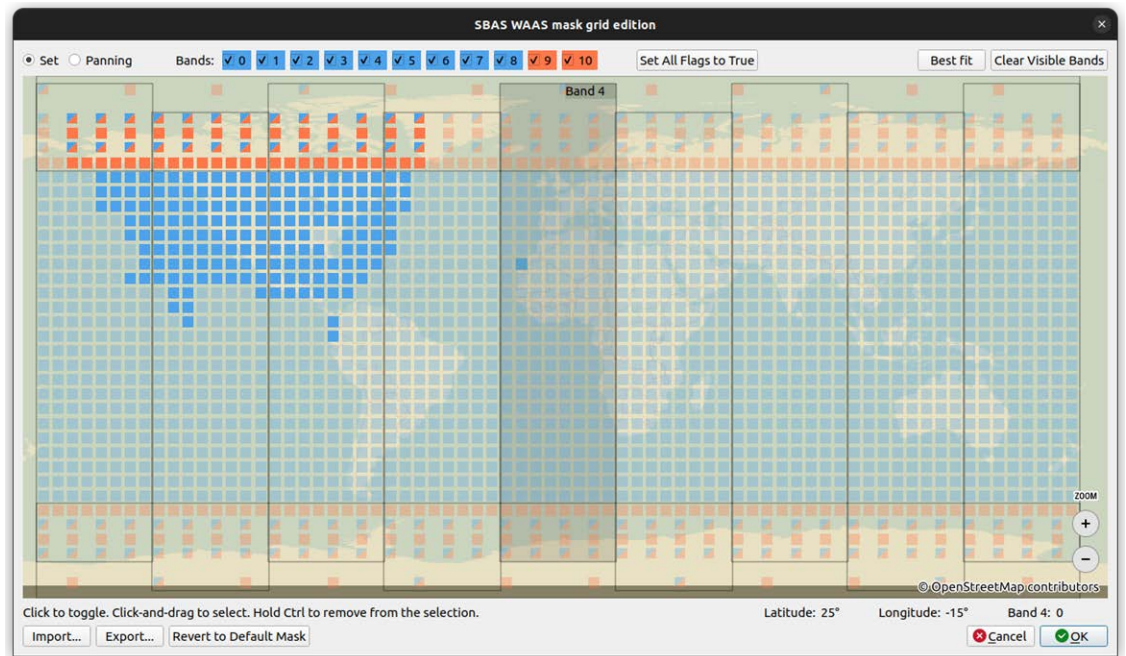

Each IGP can be selected and set to true or false by lighting them up or off with a click of the mouse, or by dragging an area with the mouse to change the value of many points at once.

Rolling over the map with the mouse will highlight the different bands and display their number. You can select or deselect bands using the controls at the top in order to help with setting the different points' values, for example by including or excluding bands. When you deselect a band, its IGPs can't be edited, thus preventing unwanted changes.

You can import or export the grid for the current service provider in CSV format, where each line describes a grid band (0 to 11), an IGP index (1 to 201, depending on the band) and the flag applied (0 or 1). A button is provided to revert to the default mask. These are the only actions that change all the bands, whether selected or not.

Click OK to save your changes or click Cancel to revert them.

3.12.7.7 Ionospheric GIVEI

The Ionospheric GIVEI settings are located in the **Settings - SBAS - Service Providers - Service Provider - Ionospheric GIVEI** menu.

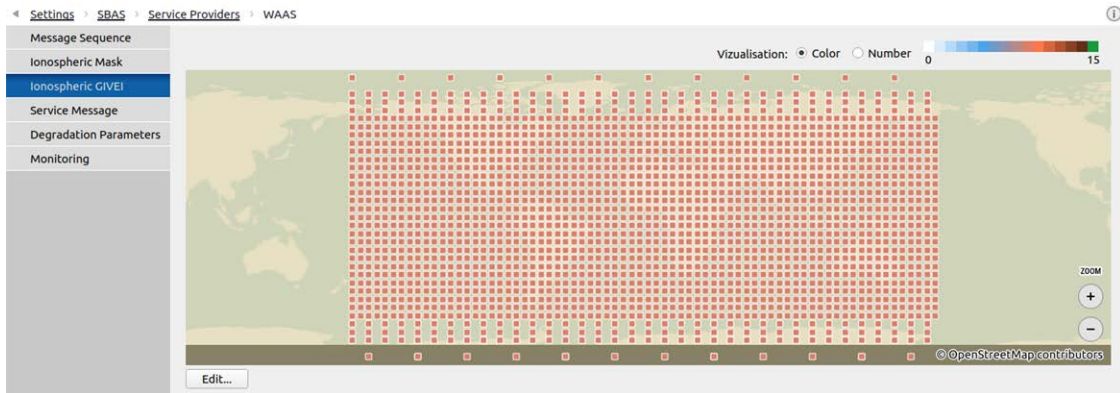

They describe the GIVE Indicators (GIVEI) used in the SBAS message 26 on an ionospheric grid, where each IGP describes a GIVEI value between 0 and 15. Each SBAS service provider has a different GIVEI map.

Information about the highlighted IGP (latitude, longitude, GIVEI value) is shown below the map.

The Edit button opens a dialog with an editable version of the map of the current service provider.

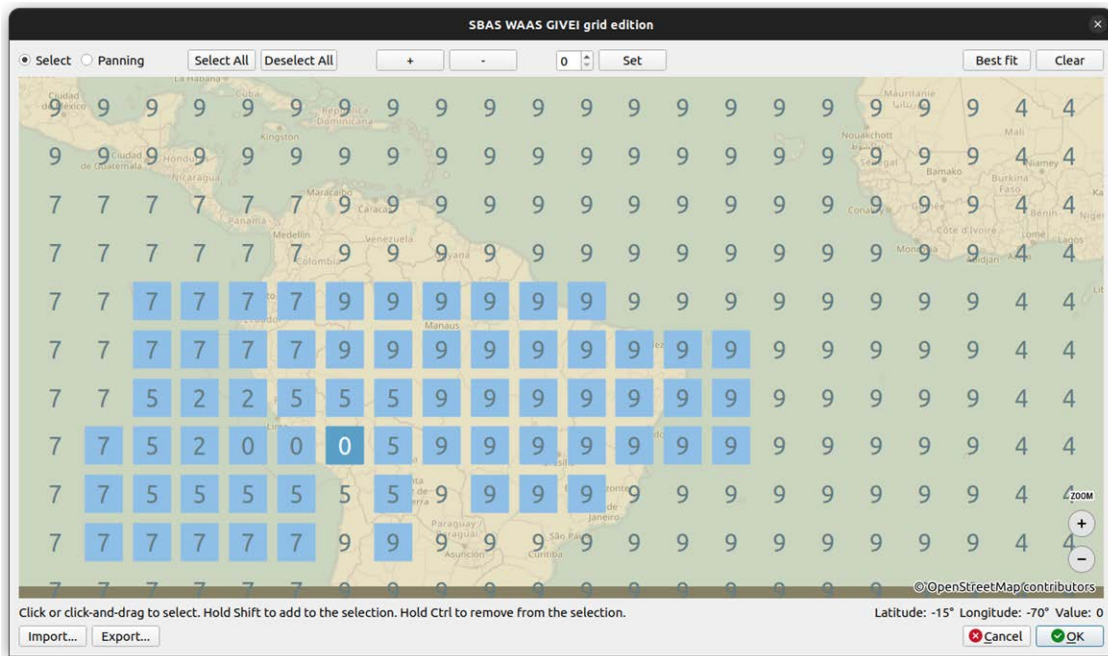

The controls provided for the edition of the GIVEI values operate in similar fashion as the ones for "Errors" on page 81.

You can import or export the grid in a CSV file following this format: [band index],[IGP index],[GIVEI value]

Click OK to save your changes or click Cancel to revert them.

3.12.7.8 Service Message

The Service Message settings are located in the **Settings - SBAS - Service Providers - Service Provider - Service Message** menu.

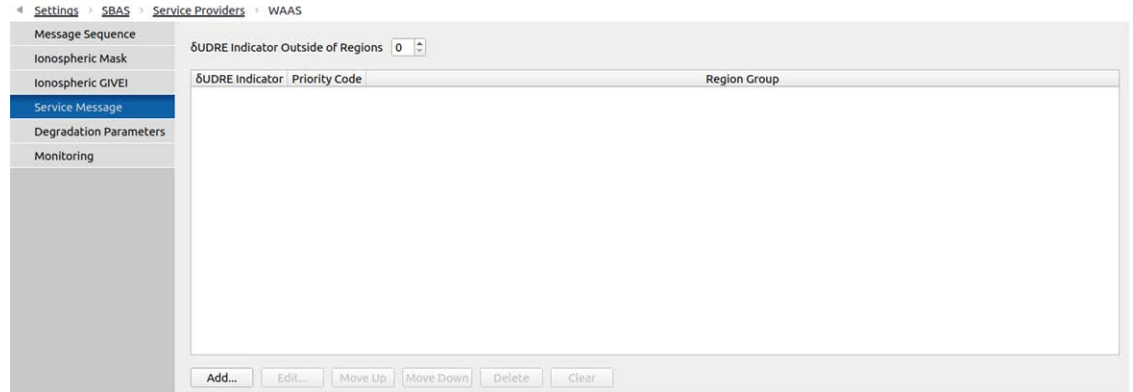

You can configure multiple region groups based on a service provider, which will be used in the SBAS message 27. A region group can have multiple regions with a triangle or rectangle shape, and define a delta UDRE Indicator and Priority Code for those regions. The default delta UDRE Indicator value output of the regions can also be configured with the top left value selection.

3.12.7.9 Degradation Parameters

The Degradation Parameters settings are located in the **Settings - SBAS - Service Providers - Service Provider - Degradation Parameters** menu.

◀ [Settings](#) ▶ [SBAS](#) ▶ [Service Providers](#) ▶ [WAAS](#)

Message Sequence	
Ionospheric Mask	
Ionospheric GIVEI	
Service Message	
Degradation Parameters	
Monitoring	

B_{rrc}	<input type="text" value="0.108"/>	m
$C_{lbc\ lsb}$	<input type="text" value="0.076"/>	m
$C_{lbc\ v1}$	<input type="text" value="0.00380"/>	m/s
$I_{lbc\ v1}$	<input type="text" value="256"/>	s
$C_{lbc\ v0}$	<input type="text" value="0.304"/>	m
$I_{lbc\ v0}$	<input type="text" value="100"/>	s
$C_{geo\ lsb}$	<input type="text" value="0.1555"/>	m
$C_{geo\ v}$	<input type="text" value="0.00415"/>	m/s
I_{geo}	<input type="text" value="256"/>	s
C_{er}	<input type="text" value="3.0"/>	m
$C_{iono\ step}$	<input type="text" value="0.836"/>	m
C_{iono}	<input type="text" value="300"/>	s
$C_{iono\ ramp}$	<input type="text" value="0.000000"/>	m/s
RSS_{udre}	<input type="text" value="0"/>	
RSS_{iono}	<input type="text" value="0"/>	
$C_{covariance}$	<input type="text" value="0.0"/>	

This menu displays the current values assigned to each degradation parameter for the service provider. Each value can be modified during the idle state by clicking on the corresponding input box.

3.12.7.10 Monitoring

The Monitoring settings are located in the [Settings - SBAS - Service Providers - Service Provider - Monitoring](#) menu.

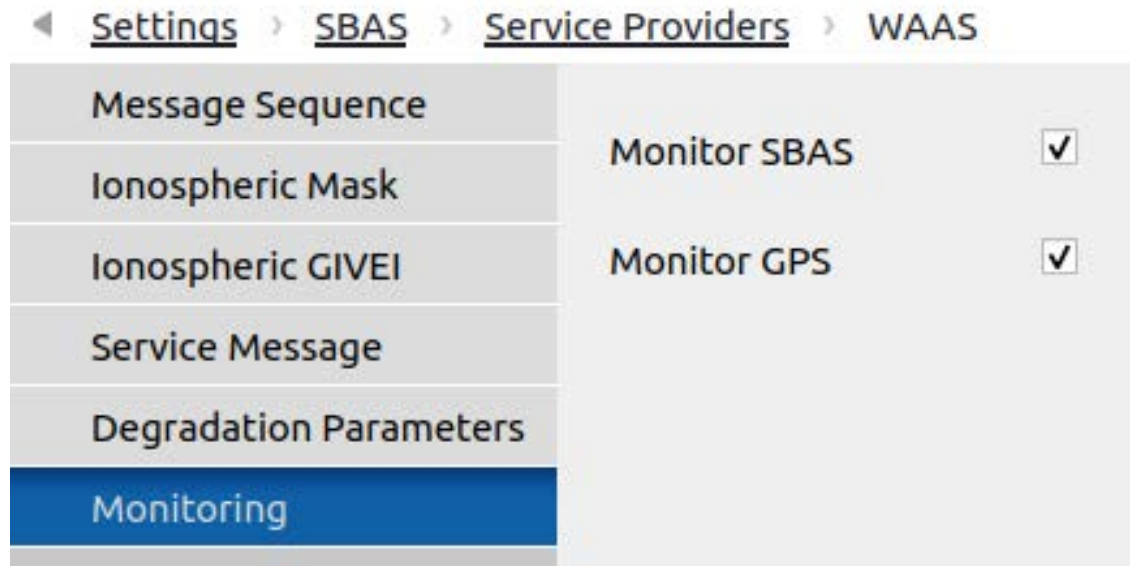

The monitored constellation is directly reflected in the SBAS PRN mask of the service provider. When a system is set to Monitored, Skydel attempts to initialize the SBAS PRN mask based on two factors:

1. Whether the Monitor option is enabled
2. The satellites from that constellation currently available in the configuration



Note: The SBAS PRN mask is broadcast in Message Type 1.

3.12.8 PULSAR

The PULSAR settings are located in the **Settings - PULSAR** sub-menu.

The PULSAR settings control the orbits, downlink data, and signals of the PULSAR satellites. These settings have no effect on the other constellations (i.e., GPS, GLONASS, Galileo, SBAS, BeiDou, QZSS and NavIC).

The PULSAR settings are nearly identical in operation to the GPS settings. Refer to the "[GPS](#)" on page 106 settings section for more information.

3.12.9 Custom Constellation

The Custom Constellation settings are located in the **Settings - Custom Constellation** sub-menu.

The Custom Constellation settings control the orbits, downlink data, and signals of the Custom Constellation satellites. These settings have no effect on the other

constellations (i.e., GPS, GLONASS, Galileo, SBAS, BeiDou, QZSS, NavIC and PULSAR).

The Custom Constellation settings are nearly identical in operation to the GPS settings. Refer to the "[GPS](#)" on page 106 settings section for more information.

3.12.9.1 General

The General settings are located in the **Settings - Custom Constellation Name - General** menu.

When importing a Custom Constellation RINEX or SP3, Skydel supports the non-standard key "K" to identify the Custom Constellation satellites.



Resources: For detailed information on creating a Custom Constellation, please refer to the following link: [Creating Custom Signals](#)

3.13 Settings: Vehicle

The Vehicle settings are located in the **Settings - Vehicle** menu.

The Settings: Vehicle subsections include: "[Body](#)" below, "[Track Playback](#)" on page 168, "[Vehicle Simulation](#)" on page 175, "[Hardware-In-the-Loop](#)" on page 176, "[Earth-Orbiting Spacecraft](#)" on page 177, "[Antenna](#)" on page 181, and "[Elevation Mask](#)" on page 185

You can use the Vehicle settings to control the trajectory and antenna properties of the simulated vehicle. This vehicle corresponds to the simulated receiver location.



Caution: Skydel users require the EXLI license feature in order to simulate vehicle trajectories with speeds higher than 600m/s.

3.13.1 Body

The Body settings are located in the **Settings - Vehicle - Body** menu.

The Body settings can be used to control the trajectory of the simulated vehicle. To define the vehicle trajectory, select the desired trajectory type and click the Edit button.

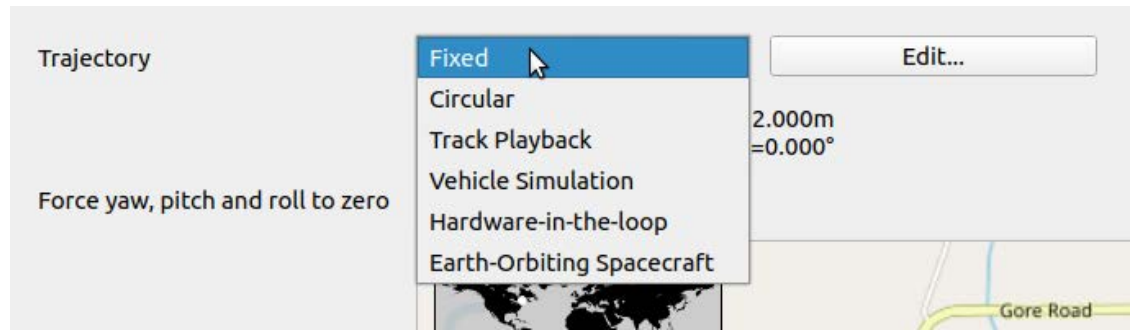

The map and location search features of the trajectory editors will not work if you are not connected to the internet. Check the "[Proxy](#)" on [page 35](#) section for more information.

Six Degrees of Freedom

Skydel uses the [Earth-Centered, Earth-Fixed](#) (ECEF) geographic coordinate system. It represents positions as X, Y and Z coordinates. The point (0,0,0) is defined as the center of mass of the Earth. Its axes are aligned with the international reference pole (IRP) and international reference meridian (IRM) that are fixed with respect to the surface of the Earth.

The z-axis is pointing towards the north. The x-axis intersects the sphere of the Earth at 0° latitude (the equator) and 0° longitude (Greenwich). This means the ECEF rotates with the Earth.

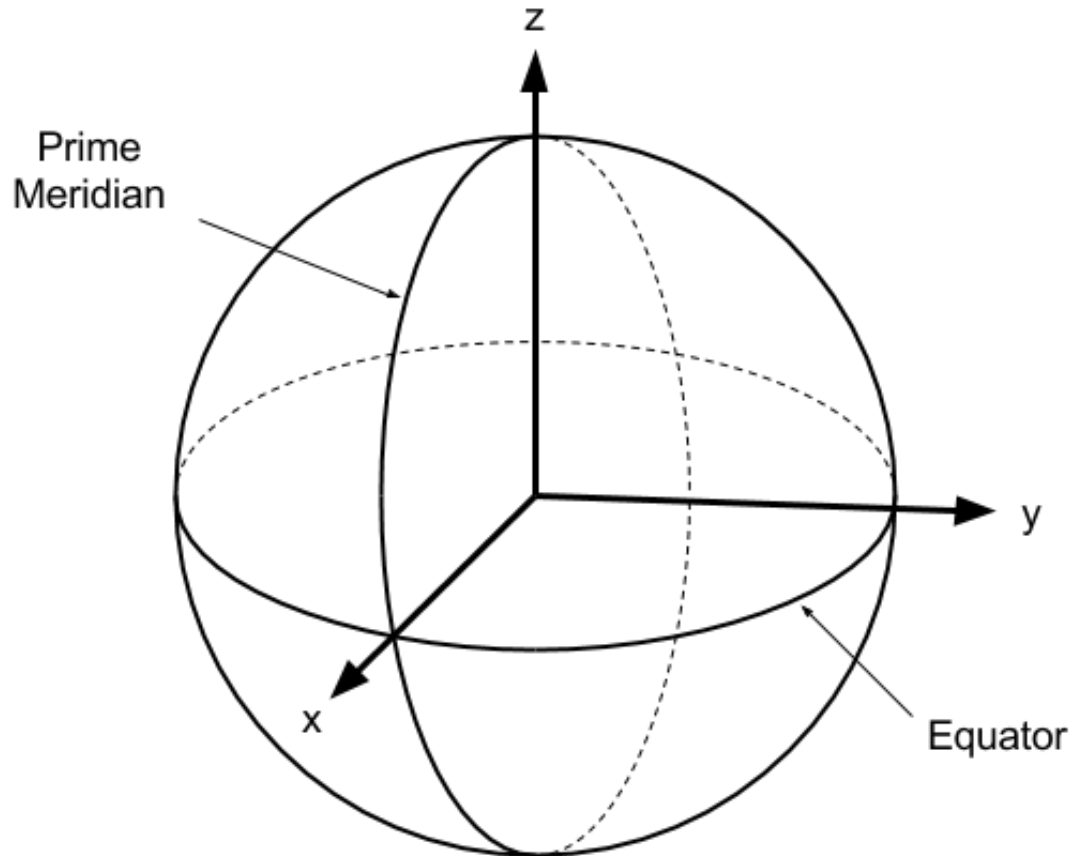

Skydel also supports the Latitude, Longitude and Altitude (LLA) geographic coordinate system. Internally, Skydel always works in ECEF and will convert LLA using the [WGS84](#) ellipsoid model. Skydel assumes the altitude in the LLA coordinate is relative to the ellipsoid surface. It is often confused with mean sea level or the geoid model.

Skydel also supports the Earth-Centered Inertial (ECI) coordinate system. Internally, Skydel always works in ECEF and will convert ECI using the current Earth Orientation Parameters.

Skydel uses the [Tait-Bryan angles](#), also known as nautical angles. It is the convention normally used for aerospace applications, so that zero degrees elevation represents the horizontal attitude. Among the six possibilities of representing the rotation axes for Tait-Bryan angles, Skydel uses the z-y'-x'' intrinsic rotation. The rotation angles are yaw, pitch and roll in the NED reference frame. The x axis points north, the y axis points east, and the z axis points towards the center of the Earth. The first rotation is around z axis, the second around y axis and the third around the x axis. This transformation is also known as 3-2-1.

Fixed

To create a simulation where the receiver never moves, select the Fixed trajectory. This is sometimes referred to as a static trajectory. Click Edit to change the receiver position.

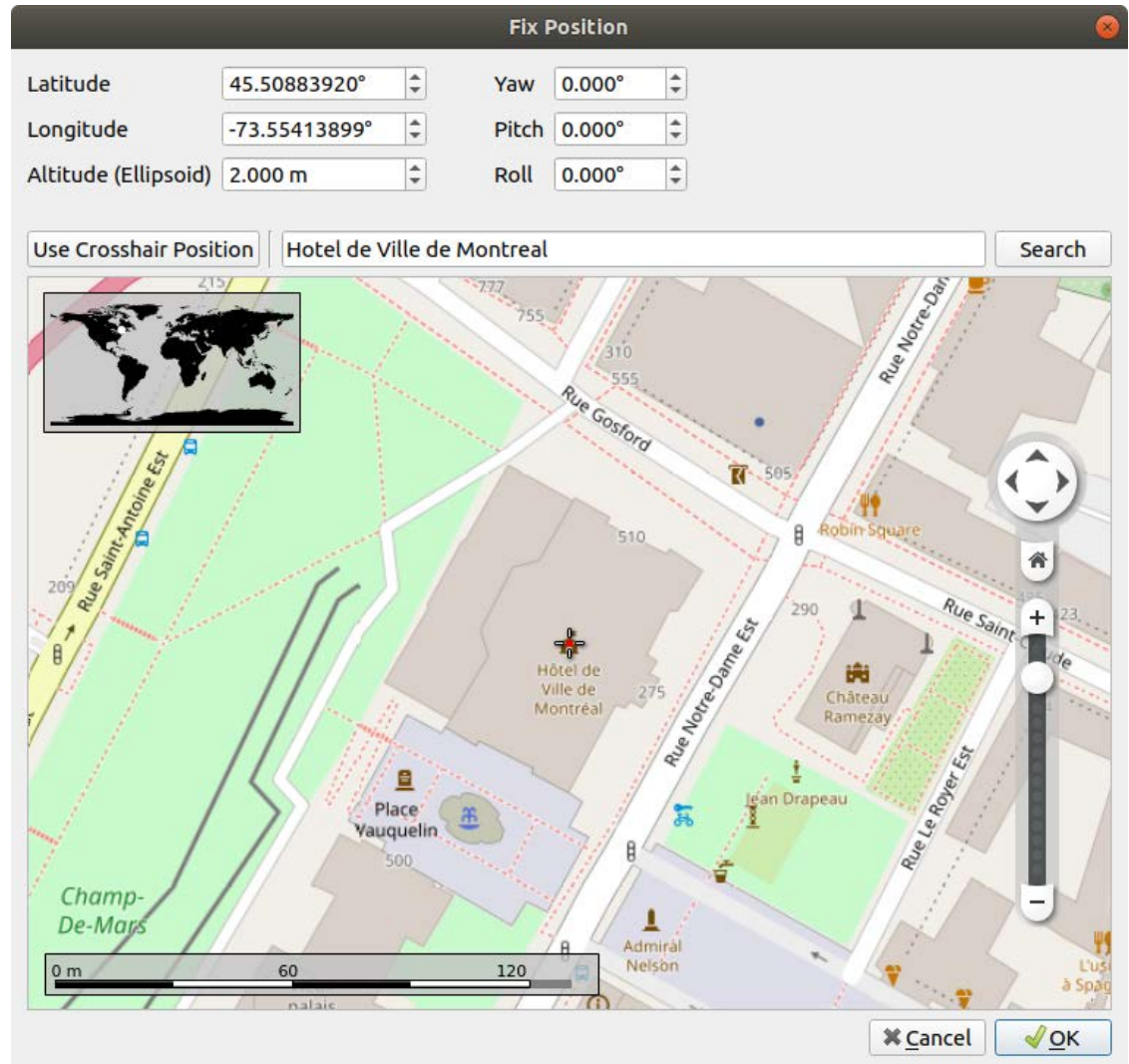

You can specify the latitude, longitude, altitude, yaw, pitch, and roll manually. Alternatively, you can “Use Crosshair Position” or search for a landmark or address. The map will display a preview of the location that you selected.

Circular

To create a quick trajectory with motion, use the Circular trajectory. A nice feature of the circular trajectory is that it is easy to make it run forever. However, many receivers have difficulty navigating with a perfectly circular trajectory. Radius, speed, and direction are editable parameters.

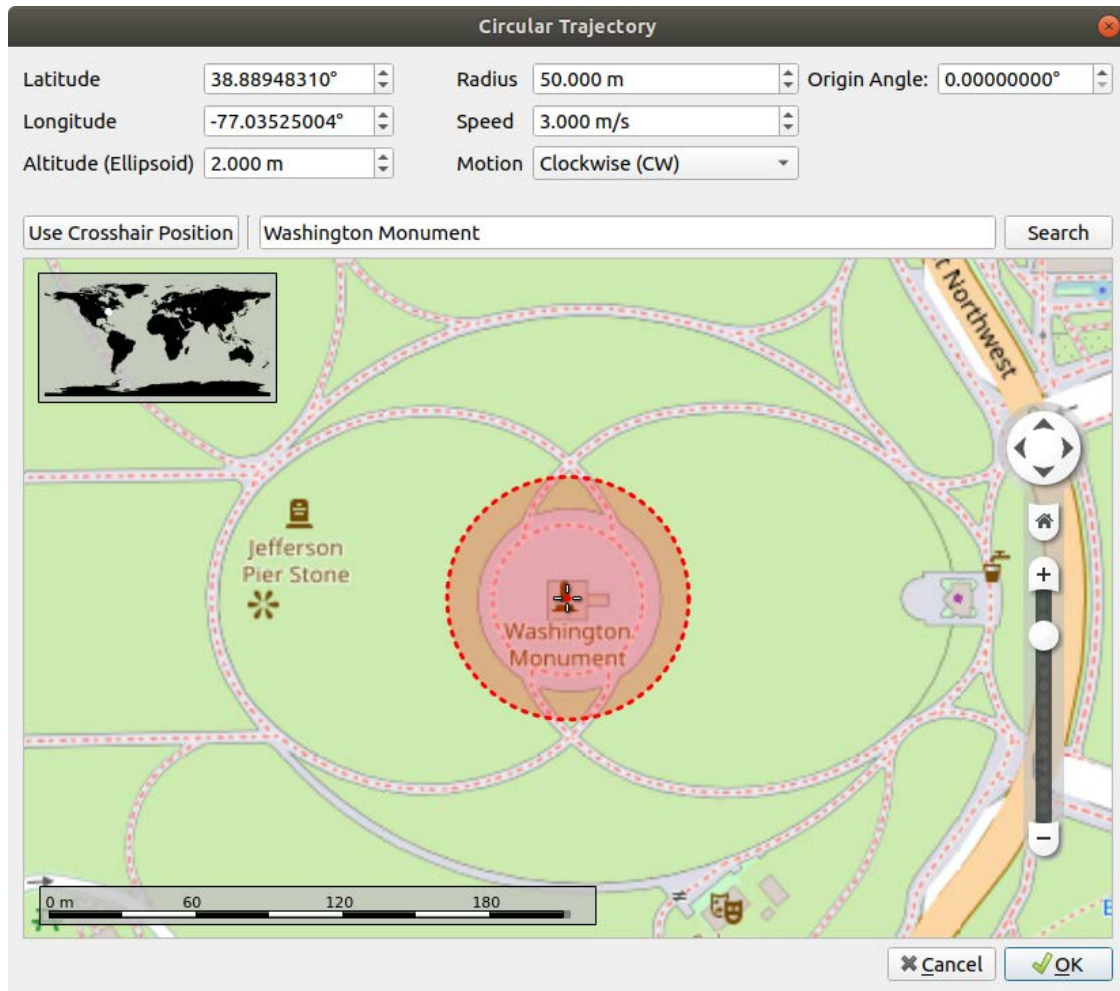

Track Playback

A track is defined as a list of locations with timestamps for each location. A NMEA file is a typical example of track, but it could also be a CSV file. If your CSV file contains speed instead of timestamps, then it is a route (see "[Vehicle Simulation](#)" on page 175), not a track.

If you have trajectory data stored in a file already, use the Track Playback trajectory. You can select your vehicle type to be Ground/Water or Airborne/Spaceborne. This selection will determine the type of interpolation that is used on your trajectory.

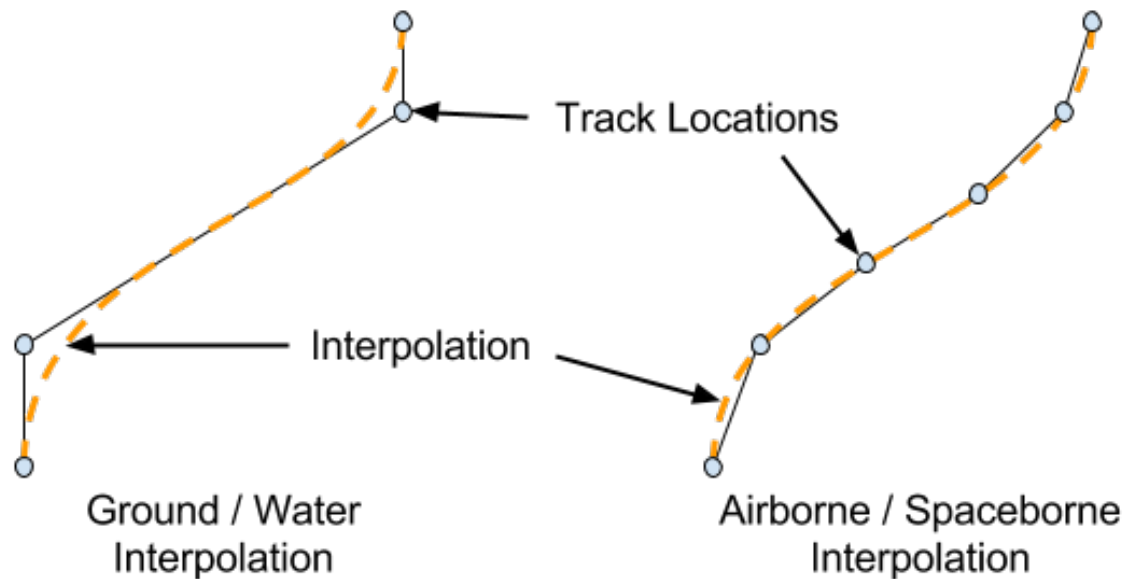

For ground and water interpolation, Skydel will not go through each location defined in the track file. For airborne and spaceborne, Skydel assumes the data points are generated by a simulator where each location is valid. Skydel will use hundreds of points to interpolate and pass through each location with minimal acceleration and jerk.

You can force the yaw, pitch, and roll to zero. This can be useful if you don't want to model the attitude of the vehicle to affect the signal power of the received signals (due to antenna pattern modeling). Interpolation can be disabled but this is not recommended. Once you have made your selection, click the edit button to define the trajectory.

When importing a trajectory, you can choose between a NMEA file or a CSV file.

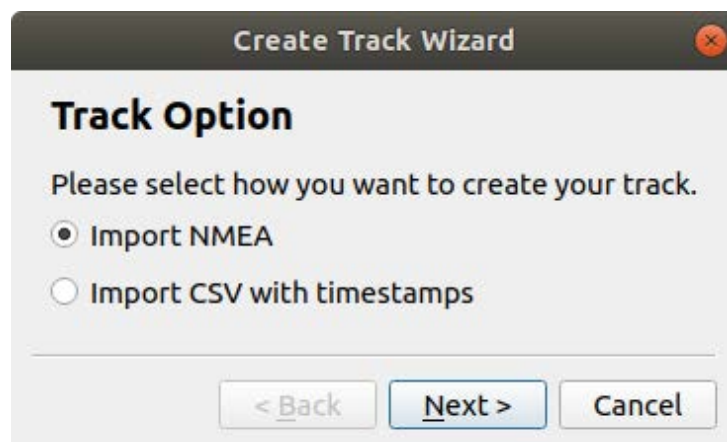

When importing NMEA data, you will be asked to locate a file that contains NMEA strings. Once you have located the file, Skydel will try to import the data and will then display the following report:

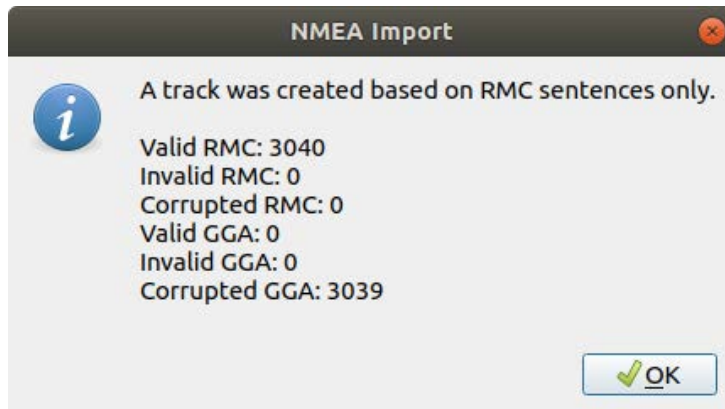

The most common source from such a file is the output of a GPS receiver. Skydel will automatically reject sentences if the fix quality is zero. Occasionally, the NMEA file is generated by a trajectory simulation tool and these tools don't always correctly set the fix quality. If you know that the fix quality is good and want to ignore this attribute while importing the NMEA, check the "Ignore fix quality in GGA sentences" box.

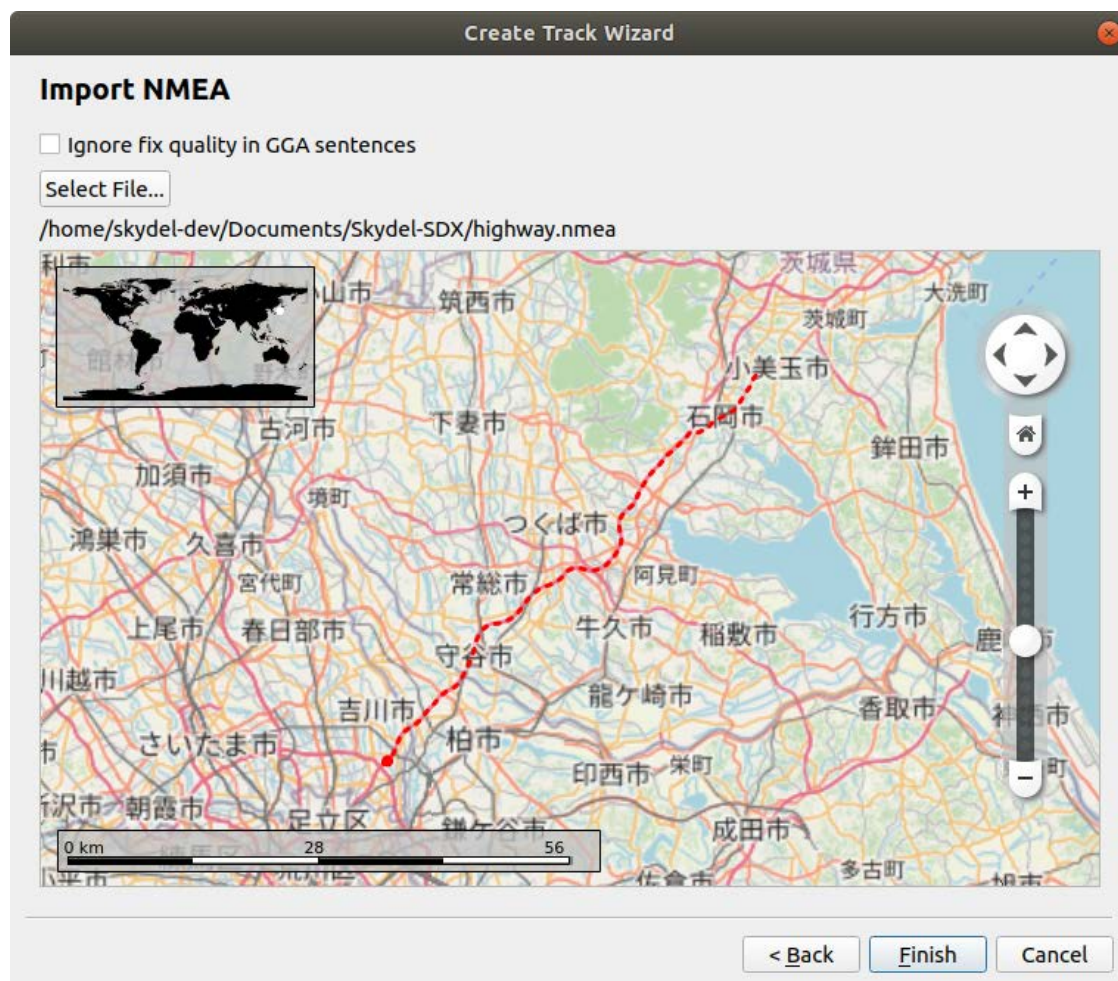

When importing CSV data, you will be asked to locate a csv file that contains trajectory data. This file doesn't have to be formatted in a specific way. Many formats are compatible with Skydel.

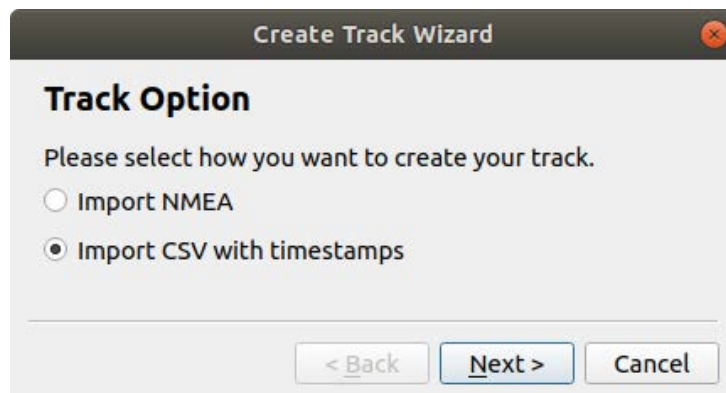

Once you have located the file to import, the Import CSV dialog will appear. Using this dialog, you specify the format of your CSV file. Make sure you set the number of header rows correctly, as it's easy to forget this step. You can choose between ECEF, ECI or LLA. Then, select which column provide X, Y, and Z for ECEF and ECI (or latitude, longitude, and altitude for LLA). You must also specify the correct units for each parameter.

Import CSV ✖

	1	2	3	4	5	6	7
1	"Time (UTCG)"	"x (km)"	"y (km)"	"z (km)"	"Angle (deg)"	"Angle (deg)"	"Angle (deg)"
2	31 Mar 2016 16:00:00.000	1351.252620	-4654.131209	4132.593477	120.005	0.000	0.000
3	31 Mar 2016 16:00:01.000	1351.254622	-4654.131364	4132.592654	120.005	-0.000	-0.000
4	31 Mar 2016 16:00:02.000	1351.260629	-4654.131828	4132.590183	120.005	0.000	0.000
5	31 Mar 2016 16:00:03.000	1351.270641	-4654.132603	4132.586065	120.005	-0.000	-0.000
6	31 Mar 2016 16:00:04.000	1351.284657	-4654.133687	4132.580299	120.005	0.000	0.000
7	31 Mar 2016 16:00:05.000	1351.302679	-4654.135082	4132.572886	120.005	0.000	0.000

Number of lines to skip for the file header Column separator

Position Attitude Time

ECEF X Y Z

Column

Unit

ECEF no value
LLA no value
Attitude no value
Time no value



Caution: It is very important to import data with sufficient precision. If the data is truncating too many decimals, the resulting position error will create extreme acceleration and jerk.

Once you are finished with the Position tab, continue with Attitude and Time.

Import CSV

	1	2	3	4	5	6	7
1	"Time (UTCG)"	"x (km)"	"y (km)"	"z (km)"	"Angle (deg)"	"Angle (deg)"	"Angle (deg)"
2	31 Mar 2016 16:00:00.000	1351.252620	-4654.131209	4132.593477	120.005	0.000	0.000
3	31 Mar 2016 16:00:01.000	1351.254622	-4654.131364	4132.592654	120.005	-0.000	-0.000
4	31 Mar 2016 16:00:02.000	1351.260629	-4654.131828	4132.590183	120.005	0.000	0.000
5	31 Mar 2016 16:00:03.000	1351.270641	-4654.132603	4132.586065	120.005	-0.000	-0.000
6	31 Mar 2016 16:00:04.000	1351.284657	-4654.133687	4132.580299	120.005	0.000	0.000
7	31 Mar 2016 16:00:05.000	1351.302679	-4654.135082	4132.572886	120.005	0.000	0.000

Number of lines to skip for the file header Column separator

Position Attitude Time

Column Format

Type

Unit

ECEF x=1351252.620m, y=-4654131.209m, z=4132593.477m
 LLA 40.64526783°, -73.81018931°, -29.939m
 Attitude Yaw=120.005°, Pitch=0.000°, Roll=0.000°
 Time 2016-03-31 16:00:00.000

Caution: When importing in ECI, it's very important that the simulation start time match to trajectory start time since the conversion to ECEF is strongly bound to Earth Orientation Parameters and time. It's possible to import custom Earth Orientation Parameters. Refer to the "[Earth Orientation](#)" on page 82 settings section for more information.

The CSV importer will display a preview of the decoded information for the first row at the bottom of the dialog box. If the information is properly decoded, it is most likely that Skydel will be able to import the CSV file successfully. Click OK to import the file.

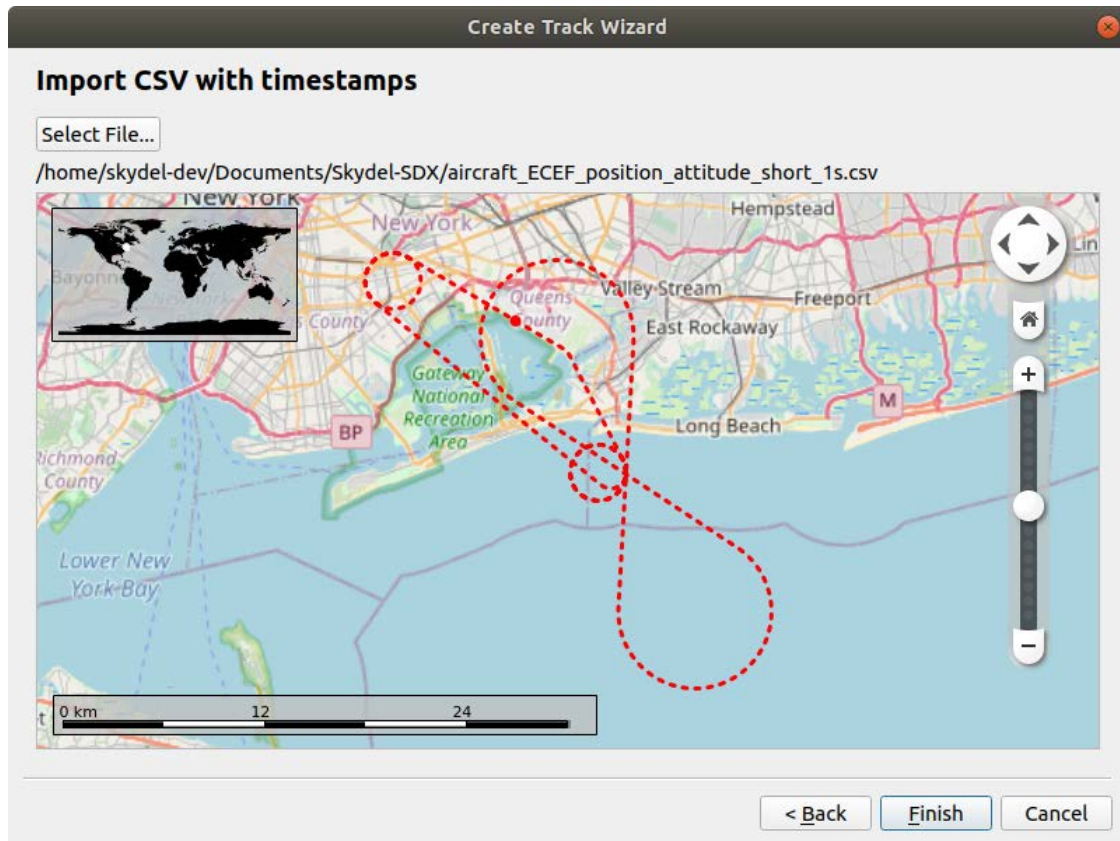

If you are satisfied with the imported trajectory preview, click Finish.



Note: The Attitude tab is optional.



Note: For best results, we recommend that you use trajectory files that are at least 10 Hz for low dynamics and 100 Hz for high dynamics. This will solve many potential issues with interpolation and inconsistencies.



Note: The conversion from ECI to ECEF is done at importation. Changing simulation start time or Earth Orientation Parameters after importation will result in an erroneous trajectory.

Vehicle Simulation

The Vehicle Simulation trajectory type is an efficient way to quickly make a realistic trajectory. If you require a very precise trajectory based on real-world data, it is recommended to use the Track Playback feature, which is better suited for such applications. You can import the data from “Use Street Map” (openstreetmap.org), “Import KML” (Google Earth or earth.google.com), or your own CSV file. The CSV file should contain a list of locations with speed values for each. If your CSV file contains timestamps instead of speed, it is considered to be a track (see “[Track Playback](#)” on page 168).

For this example, we will select Use Street Map.

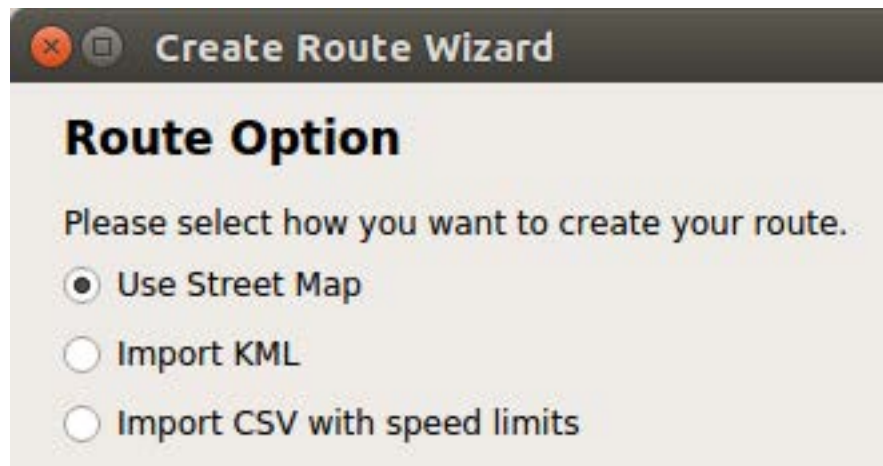

You can search for locations using the From and To fields. Or you can right-click on the map and select “Direction From/To Here”. The map will display a preview of your selected trajectory.

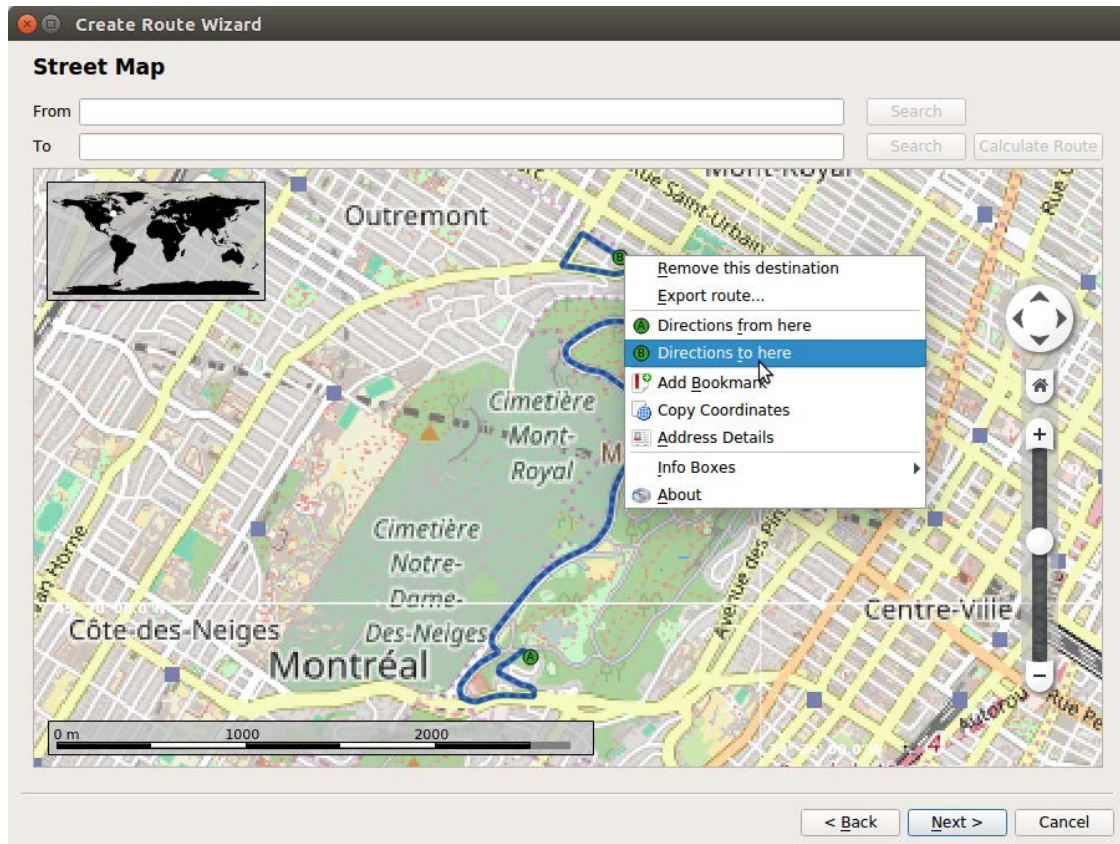

Click “Next” when you are ready. You will then be asked to select a vehicle speed. The vehicle speed represents the target speed that Skydel will attempt to maintain for the segment. However, the actual speed may vary depending on the curvature of the trajectory to better simulate realistic and smooth cornering effects.

Vehicle Speed

Please select your vehicle speed.

50.00 km/h
▲▼

Hardware-In-the-Loop

Skydel supports [“Hardware-in-the-Loop \(HIL\)” on page 228](#) trajectories. This trajectory type requires a remote process to connect to Skydel and send the vehicle position in real-time.

 **Caution:** Skydel users require the HIL license feature in order to use the HIL trajectory type.

Earth-Orbiting Spacecraft

You can easily create Earth-Orbiting Spacecraft trajectories to test spaceborne receivers.

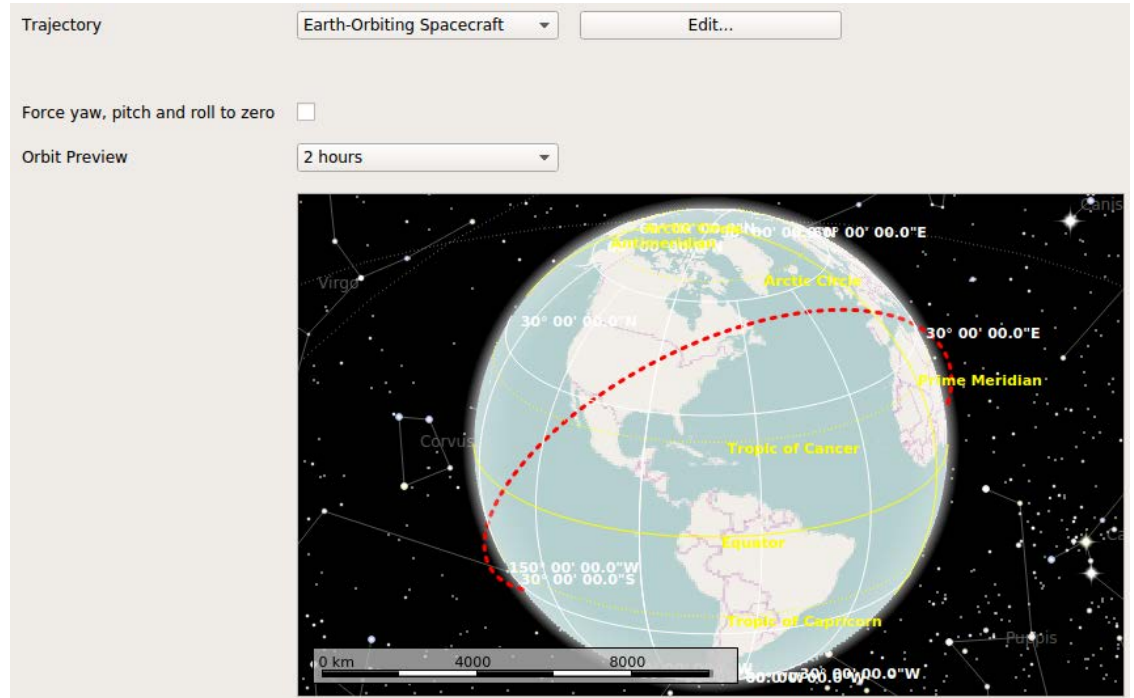

When you click Edit, Skydel will ask for the Keplerian parameters that you would like to use for your trajectory.

Keplerian Elements

Reference Time	<input type="text" value="2015-11-26T13:42:35Z"/>	
Semi-Major Axis	<input type="text" value="6782093.08"/>	m
Inclination Angle	<input type="text" value="51.6203"/>	deg
Right Ascension	<input type="text" value="353.9390"/>	deg
Eccentricity	<input type="text" value="0.00099770"/>	
Mean Anomaly	<input type="text" value="299.6610"/>	deg
Argument of Perigee	<input type="text" value="198.2108"/>	deg

When using Earth-Orbiting Spacecraft trajectories, you will be warned that some other settings should change. If you click “Tell me more..”, Skydel will offer to make some of the changes for you.



Other settings for the vehicle and for the atmosphere must be set when using spacecraft trajectory.

This diagram depicts a Low Earth Orbit (LEO) trajectory. If your trajectory is close to a LEO, you should click “Use LEO Settings” to accept these changes.

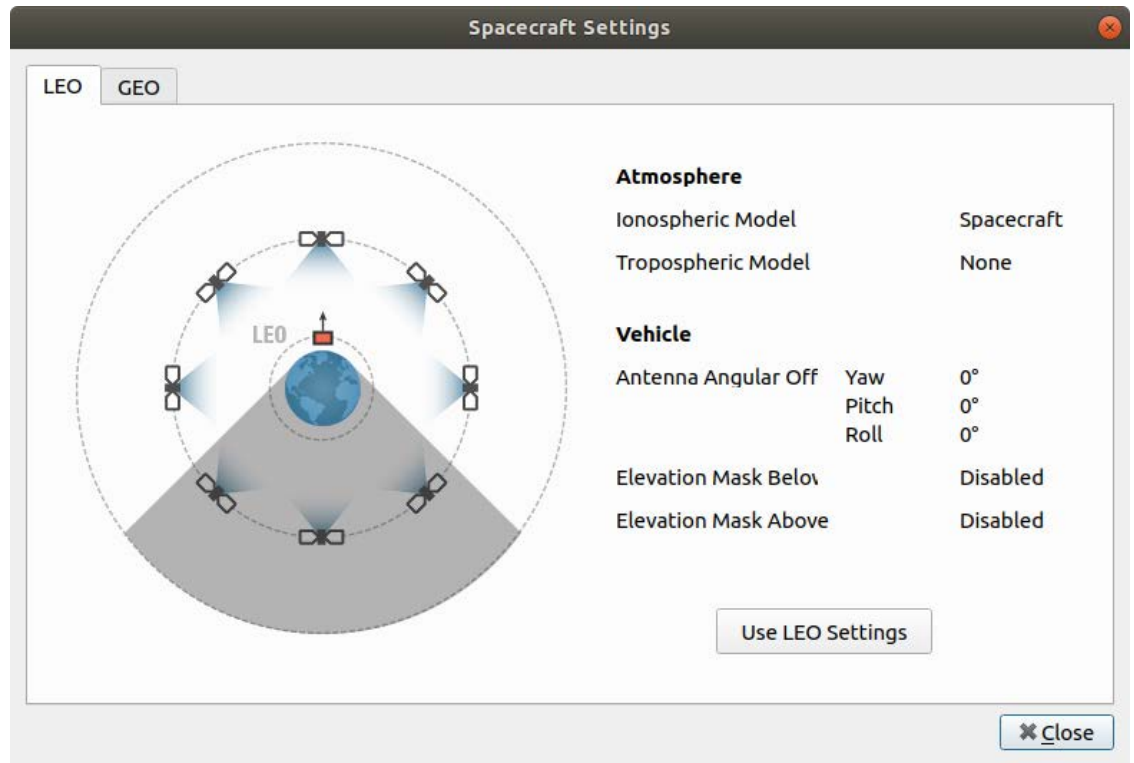

This diagram depicts a Geostationary Earth Orbit (GEO) trajectory. If your trajectory is close to a GEO, you should click “Use GEO Settings” to accept these changes.

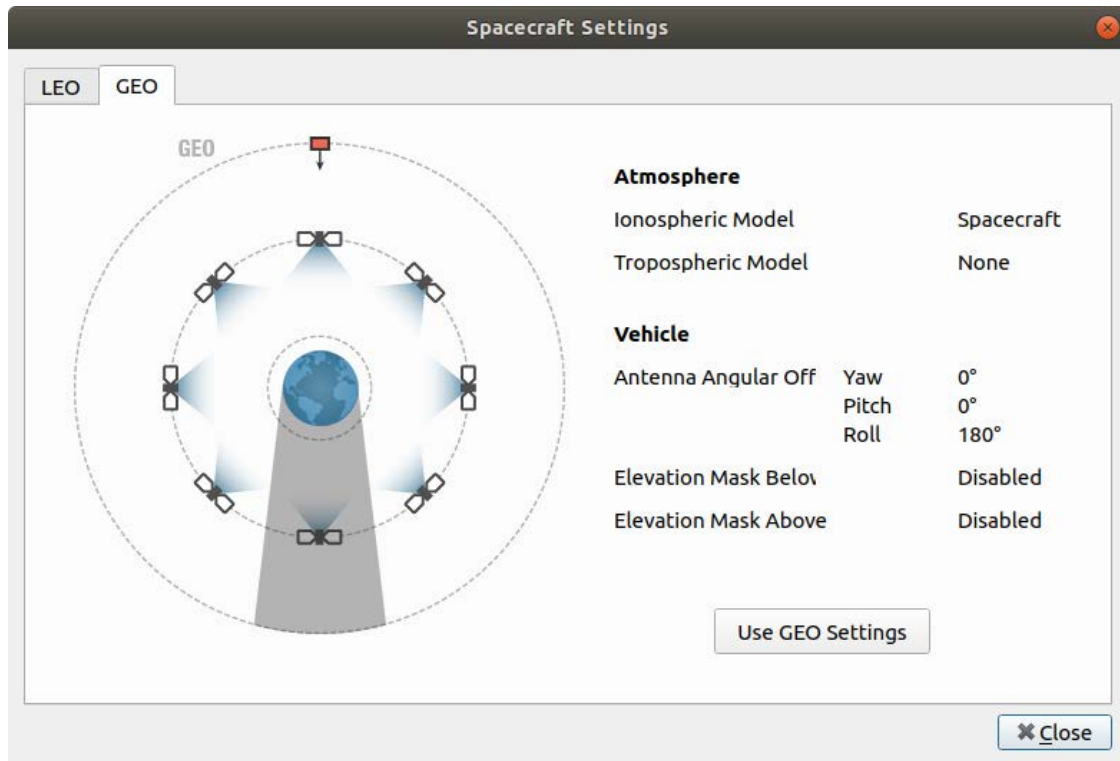

A space receiver will have many more satellites in view than a ground receiver. This will require additional computing demand on the GPU. You can easily see this by looking at the sky view. Satellites with a horizontal line are beneath the receiver. Their elevation angle is less than zero. Satellites with a dot have their back to the receiver. Their main beams are facing away from the receiver; therefore, the received power from these signals will be quite low. The blue circle in the middle represents the Earth.

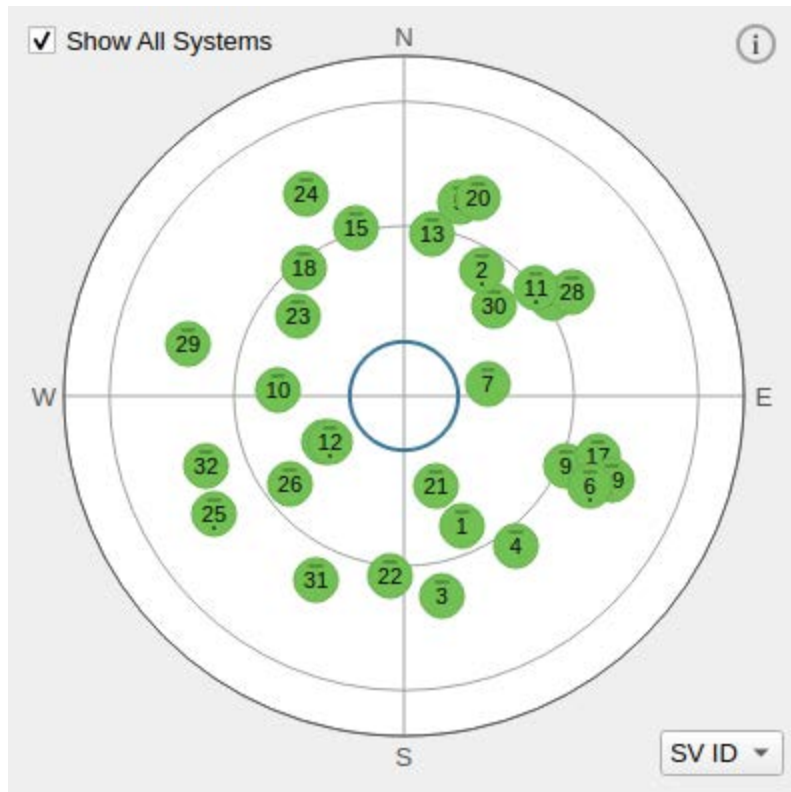

Space receivers are usually not within the main lobe of a given GPS satellite's main antenna. This results in a very wide range of received power levels. You can see this by looking at the Power Sliders. Notice that weaker satellites each have a dot under their number.

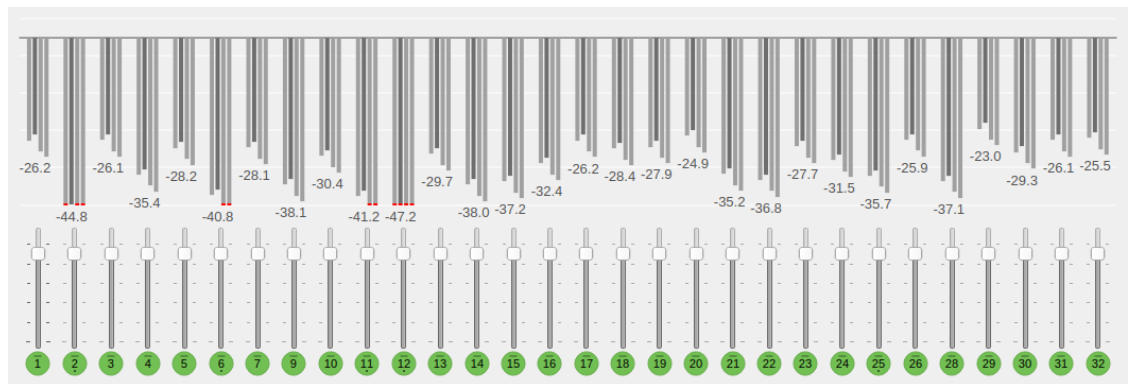

3.13.1.1 Antenna

The Antenna settings are located in the **Settings - Vehicle - Antenna** menu.



Note: This section refers to parameters pertaining to the vehicle's antenna (receiver). For the GNSS satellite's antenna (transmitter), refer to section [GPS "Antenna" on page 138 Model](#).

You can use the Antenna settings to change how the receiver antenna is modeled. Changing the antenna model will affect the power and phase offset of received signals. Phase offsets are expressed in angles.

You can define one or more antenna models in **Models** and use the **Sequencer** to specify antenna model changes to occur during the simulation. By default, Skydel uses the default antenna defined in the Models menu.

Models

This screen shows a list of antenna models available for your simulation.

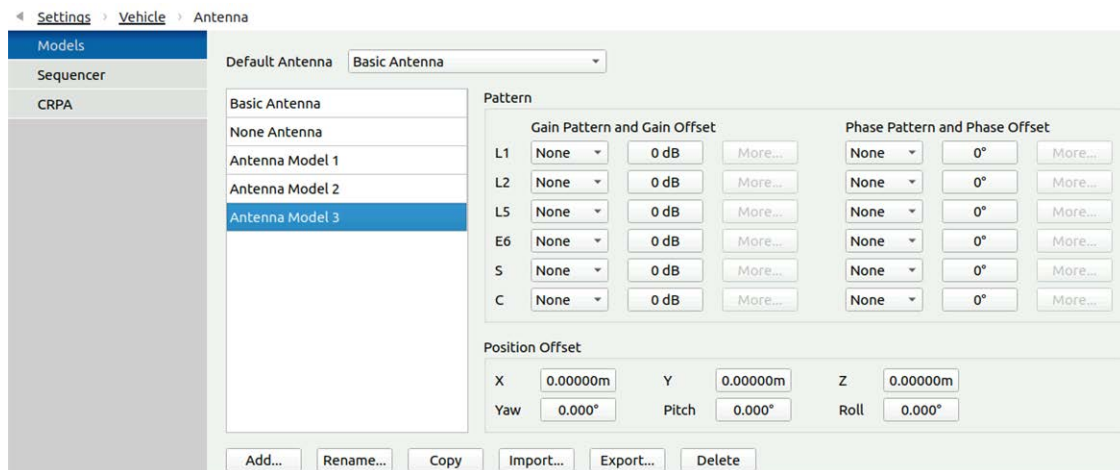

The Vehicle Antenna Models interface behave exactly like GPS Antenna Models (see ["Antenna" on page 138](#)). Gain and phase offset patterns have the same formats. Please refer to the GPS Antenna Models for a complete description.

The default pattern for a vehicle contains 181 lines: elevation step is 1° and azimuth is always the same.

Antenna Offset

You can also specify the attachment point and attitude of the antenna relative to the vehicle body (see ["Six Degrees of Freedom" on page 165](#)). The default attachment point (sometimes referred to as "lever arm") of X = 0, Y = 0, and Z = 0 meters puts the antenna at the center of the vehicle. The default attitude of yaw = 0, pitch = 0, and roll = 0 orients the antenna so that it faces the zenith (towards

the sky) when the vehicle is “flying straight and level”. The following diagram illustrates the relationship between the vehicle and X, Y, Z, roll, pitch, and yaw.

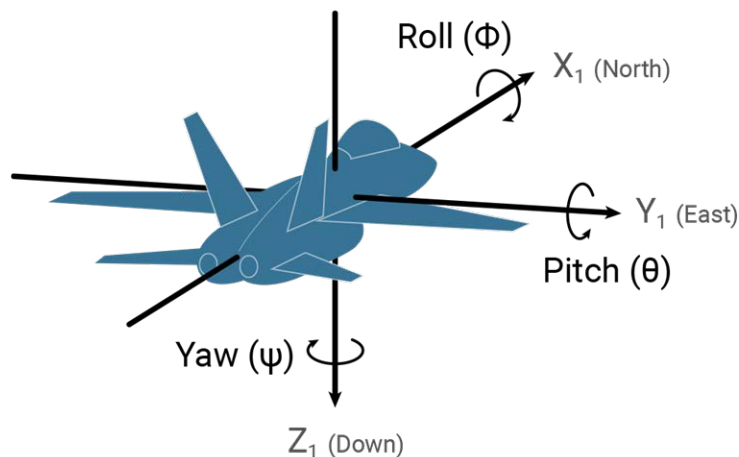

Sequencer

With the sequencer, you can plan antenna model changes that will be effective during simulation. If there’s no antenna defined at time=0 of the simulation, the default antenna will be used until another antenna is specified.

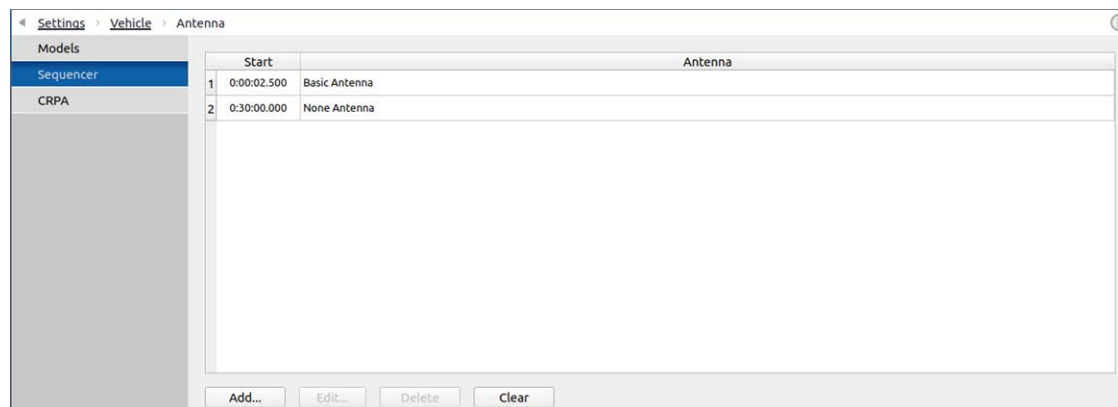

Antenna model changes are persistent; e.g., an antenna will remain active until the end of the simulation if there are no other changes.

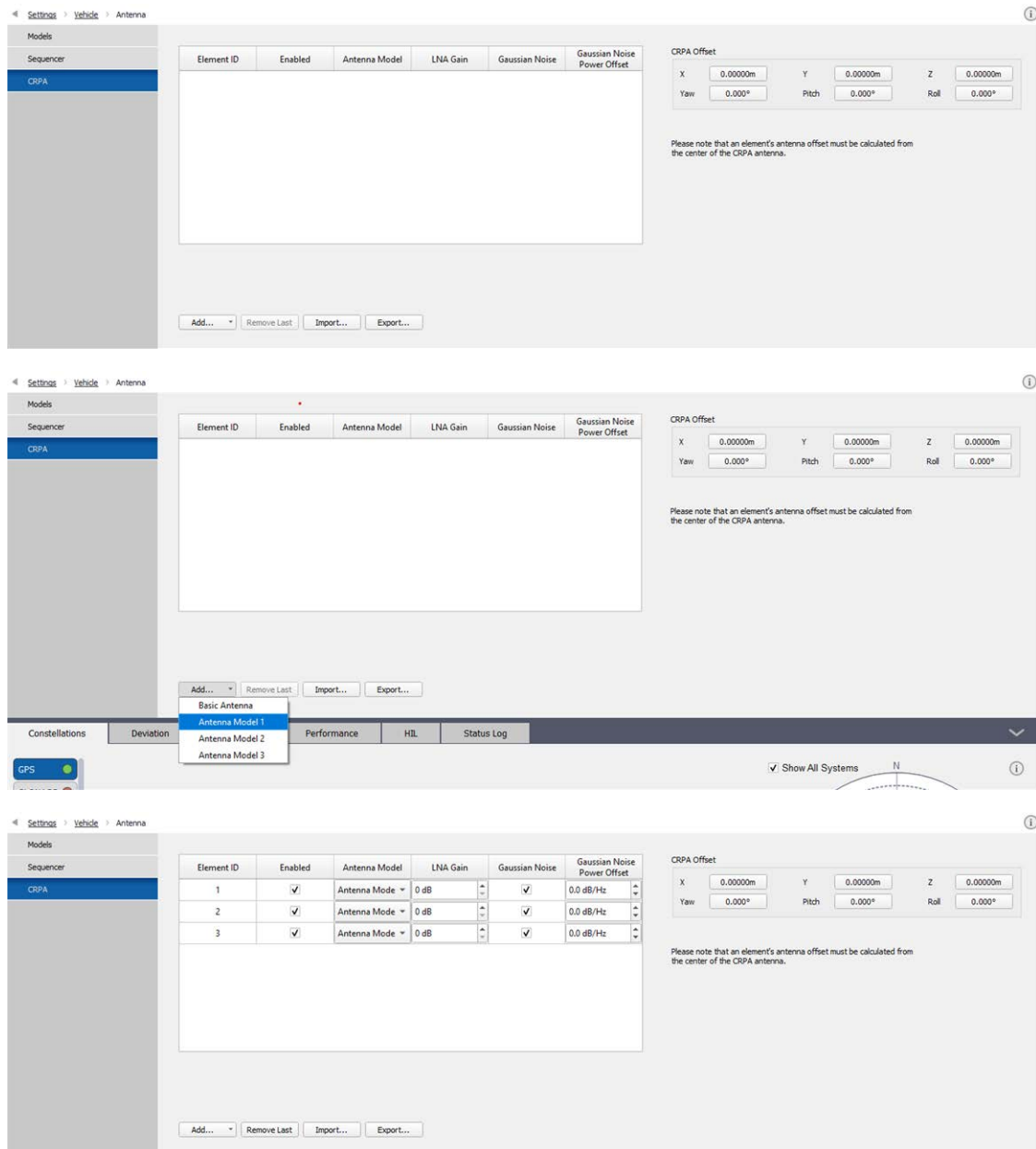

Settings > Vehicle > Antenna

Models

Sequencer

CRPA

Element ID	Enabled	Antenna Model	LNA Gain	Gaussian Noise	Gaussian Noise Power Offset
1	<input checked="" type="checkbox"/>	Antenna Model 1	0 dB	<input checked="" type="checkbox"/>	0.0 dB/Hz
2	<input checked="" type="checkbox"/>	Antenna Model 2	0 dB	<input checked="" type="checkbox"/>	0.0 dB/Hz
3	<input checked="" type="checkbox"/>	Antenna Model 3	0 dB	<input checked="" type="checkbox"/>	0.0 dB/Hz

CRPA Offset

X: 0.00000m Y: 0.00000m Z: 0.00000m

Yaw: 0.000° Pitch: 0.000° Roll: 0.000°

Please note that an element's antenna offset must be calculated from the center of the CRPA antenna.

CRPA Offset

X: 0.00000m Y: 0.00000m Z: 0.00000m

Yaw: 0.000° Pitch: 0.000° Roll: 0.000°

Please note that an element's antenna offset must be calculated from the center of the CRPA antenna.

CRPA Offset

X: 0.00000m Y: 0.00000m Z: 0.00000m

Yaw: 0.000° Pitch: 0.000° Roll: 0.000°

Please note that an element's antenna offset must be calculated from the center of the CRPA antenna.

Constellations Deviation Performance HIL Status Log

GPS

Show All Systems

1. Change the Antenna Model of the element.
2. Add LNA gain to the element. This option allows to simulate a low noise amplifier at the input of the element's antenna.
3. Enable or disable the added Gaussian Noise on the element. Enabling the Gaussian Noise can improve the realism of the simulation.
4. Change the Gaussian Noise Power Offset (when Gaussian Noise is enabled). This option allows to increase or decrease the power of the added Gaussian Noise.

It is also possible to modify the "CRPA Offset", which is the position offset of the center of the CRPA antenna relative to the vehicle body.

3.13.1.2 Elevation Mask

The Elevation Mask settings are located in the Settings - Vehicle - Elevation Mask menu.

You can use the Elevation Mask settings to control which satellites will generate signals during the simulation. By default, "Mask Below Elevation Angle" is enabled and set to 10 degrees. This will disable satellites that have an elevation angle below 10 degrees. You can disable this mask completely (uncheck the box) or modify the angle itself by clicking on the value.

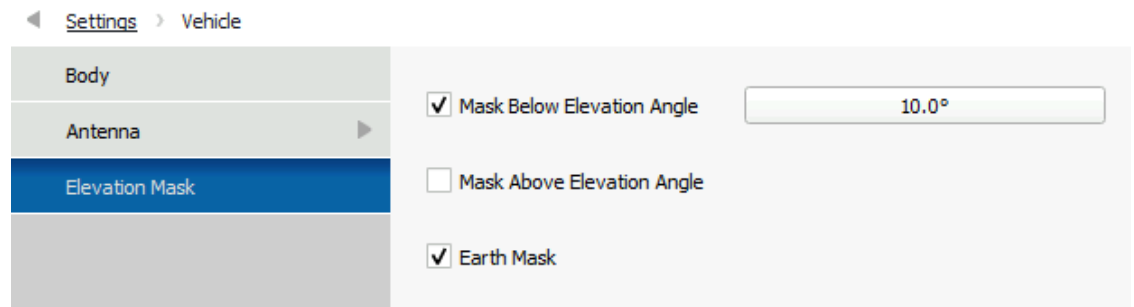

Disabling the "Mask Below Elevation Angle" is not the same as setting it to 0°. When "Mask Below Elevation Angle" is disabled, Skydel will generate signals with any elevation angle, including those below 0°. However, Skydel will still calculate the location of the Earth's horizon to determine if a satellite's signals would reach the receiver. In other words, Skydel will never generate a signal that has to pass through the Earth to be received.

You can enable the "Mask Above Elevation Angle" option. This will disable any satellite that is higher than the specified angle. This setting is not used very often and should be avoided unless you are absolutely certain of what you are doing.

By default, Skydel will calculate the location of the Earth's horizon to determine if a satellite's signals can reach the receiver. In other words, Skydel will not generate a signal that has to pass through the Earth to reach the receiver. You can change this behavior by disabling the "Earth Mask".



Caution: Disabling the Earth Mask should be used with caution, as it may produce unrealistic results and cause unexpected behaviors in the tested scenarios.

3.14 Settings: Interference

This section explains the settings for both the Advanced Spoofer and Advanced Jammer functionalities.

3.14.1 Advanced Jammer



Note: This section is about the optional Advanced Jammer feature. If you are looking for the basic interference feature, please see ["Basic Interference"](#) on page 222.

When enabled, the Advanced Jammer feature can be accessed through the Interference submenu located in the **Settings - Interference - Advanced** menu.

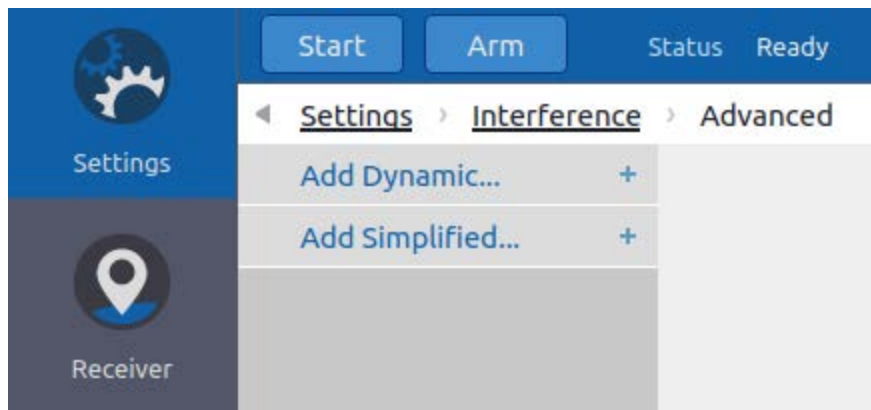
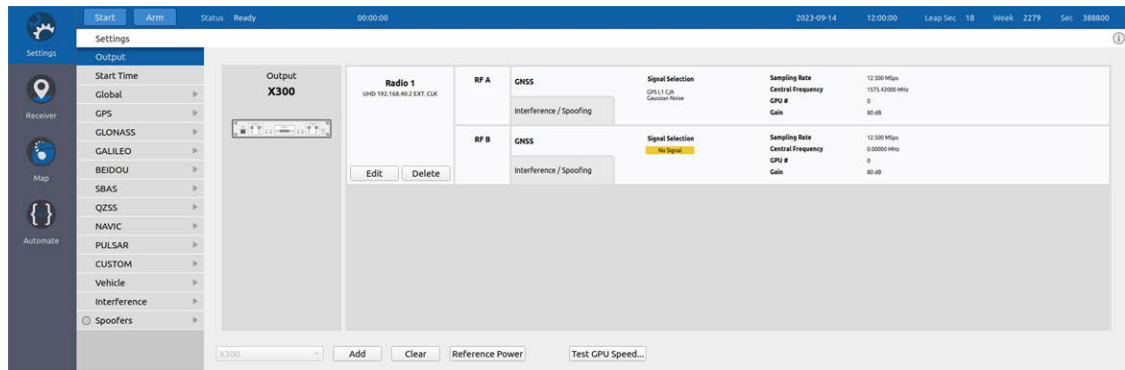

There are 2 types of advanced jammers available: Dynamic Transmitter and Simplified Transmitter.

3.14.1.1 Simplified Transmitter

A simplified transmitter has no position or trajectory. Different waveforms can be combined to create a complex waveform; however, the power is defined from the receiver point of view and will not change as it moves.



Tip: One way to look at it is Dynamic Transmitter have its own trajectory while Simplified Transmitter is attached to the receiver.

Regardless of the transmitter type (dynamic or simplified), each of the parameters can be updated in real-time while the simulation is running. It is also possible to add or remove transmitters during the simulation.

3.14.1.2 Dynamic Transmitter

A dynamic transmitter is defined with a position or a trajectory. The trajectory may even be defined in real-time using the hardware-in-the-loop API. Different waveforms (or signals) may be combined to create a complex jammer waveform. The power level is defined from the transmitter point of view. During the simulation, Skydel automatically calculates the resulting signal at the receiver antenna in real-time and takes into account the transmitter visibility, the transmitter antenna pattern, the propagation loss and the receiver antenna pattern. The transmitter, like the simulated receiver, has six degrees of freedom.

Simple dynamic transmitter tutorial

To illustrate how a dynamic jammer works with Skydel, we'll use a simple scenario where we will create an interference to jam GPS L1 C/A.

The first step is to assign GPS L1 C/A to RF A and then choose an Interference / Spoofing output on RF B.

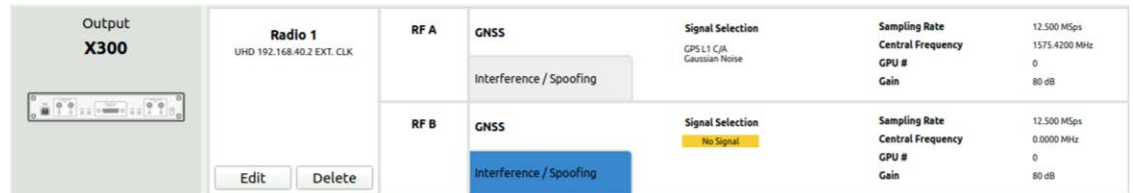

A Signal Selection dialog box will open. By default, the interference group is Group 1 and the central frequency is set to 1575.42 MHz. These values are good for this example; however, we will change the gain to **60 dB** and the minimum sampling rate to **12.5 MSps**.

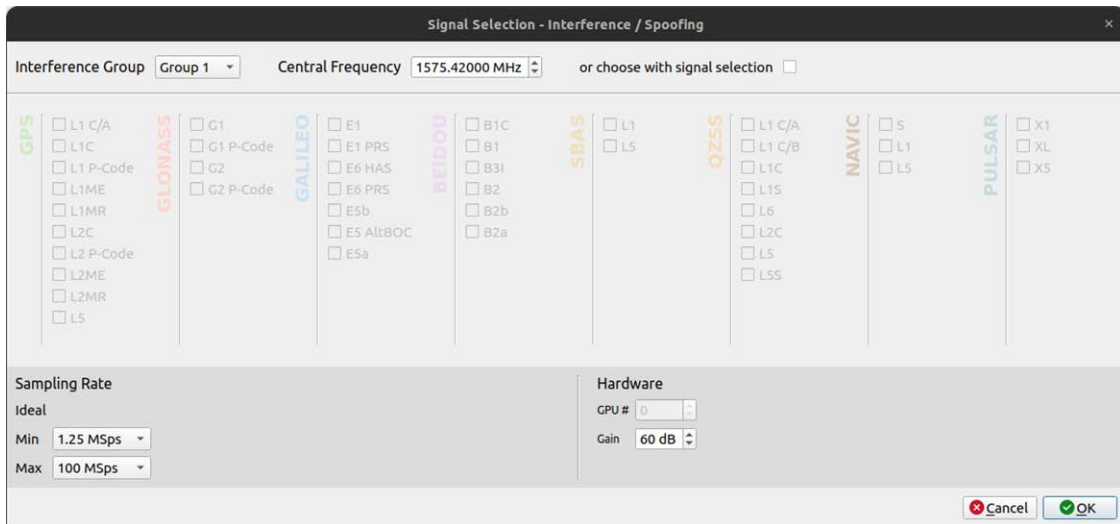

Click OK to close the Signal Selection dialog box. The output configuration should look like this:



As you can see, the gain for RF A is 80 dB and the gain for RF B is 60 dB. Before combining the outputs, RF A must be attenuated by 20 dB. While the difference in gain makes the hardware setup a little more complex, it has the great advantage of offering a much greater jammer-to-signal ratio for testing receivers under extreme conditions.

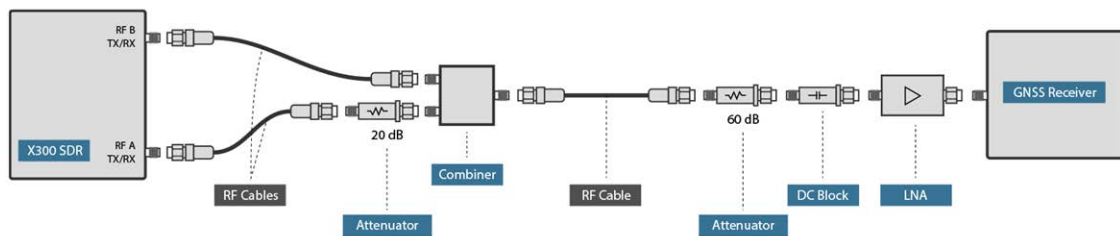



Note: In the above image, the 60 dB attenuator on the right should actually be slightly less than 60 dB and take into account the signal power loss resulting from the combiner and cables, so that the total attenuation on RF A path is 80dB and the total attenuation on RF B path is 60 dB.



Tip: You can remove the LNA and reduce the 60 dB attenuator accordingly. For example, if the LNA has 20 dB of gain, you can remove it and replace the 60 dB attenuator with a 40 dB attenuator. The power level at the GNSS receiver input will remain the same. The signal-to-noise ratio should remain valid if you have enabled the Gaussian noise option in the RF A output.

Now that we have Interference Group 1 mapped to RF B, we must add a transmitter. First, click on the interference submenu.

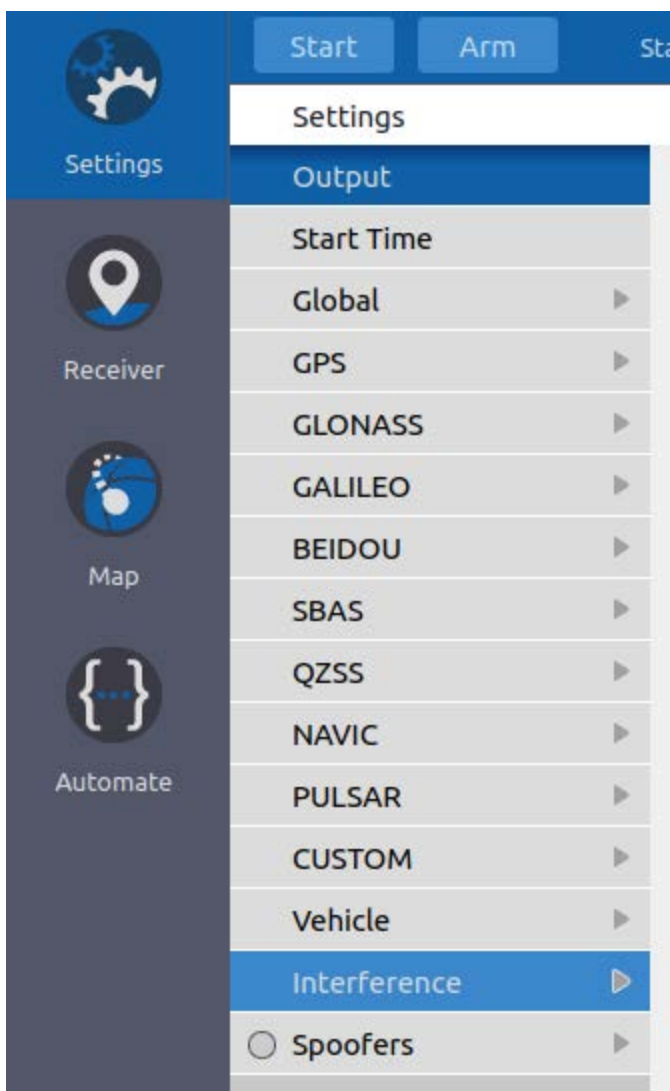

You can add ["Basic Interference"](#) on page 222 or Advanced Jammers in the Interference sub-menu.

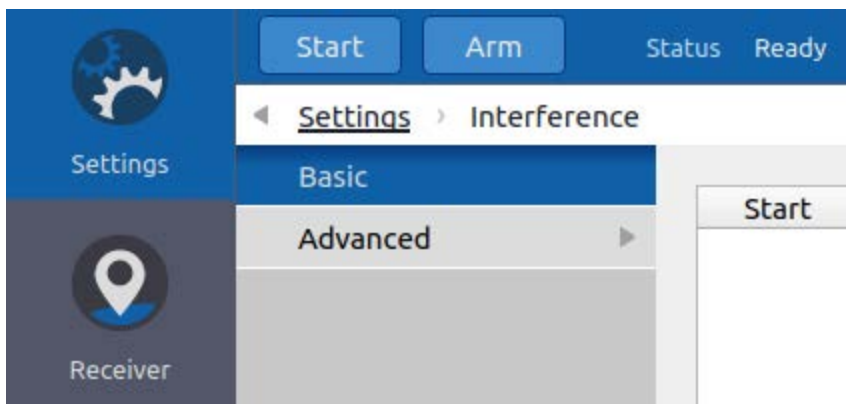

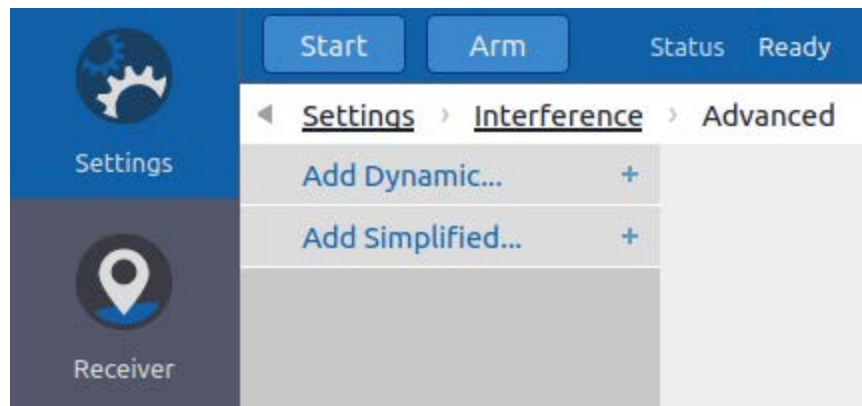

The Advanced section of the Interference sub-menu allows to add Dynamic or Simplified transmitters.

Click on "Add Dynamic..." and the "Add Transmitter" dialog box will appear.



Here you can change the transmitter name, reference power, etc. Each of these attributes can be changed later, so simply accept the default values for now. You can see the same options (Group 1 to 16) in the Group dropdown list as found in the Signal Selection dialog box. The difference is that it will tell you if the group is assigned to a physical output. In this case, it informs you that Group 1 is assigned to Radio 1 RF B. Click OK to add the dynamic transmitter.

Each time you add a transmitter, a new sub-menu with the transmitter's name appears in the Interference sub-menu. In this case, the transmitter's name is "Transmitter 1".

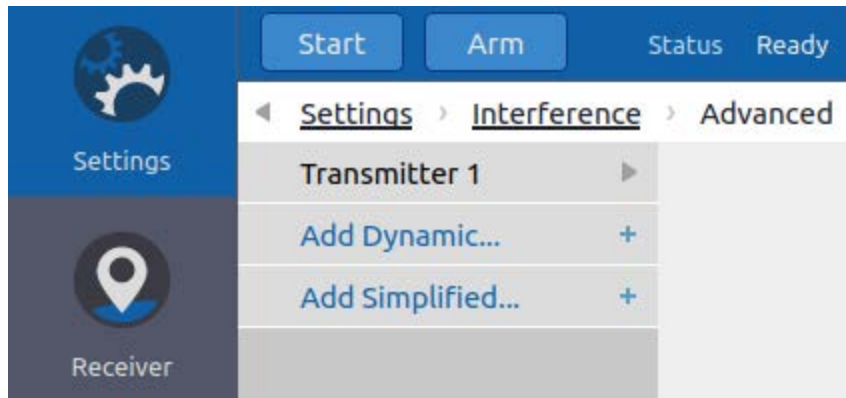

To configure the transmitter, click on the "Transmitter 1" sub-menu. The dynamic transmitter sub-menu contains four screens (General, Signal, Trajectory and Antenna) and a Remove button. In the General screen, you will see a message highlighted in yellow about an undefined trajectory.

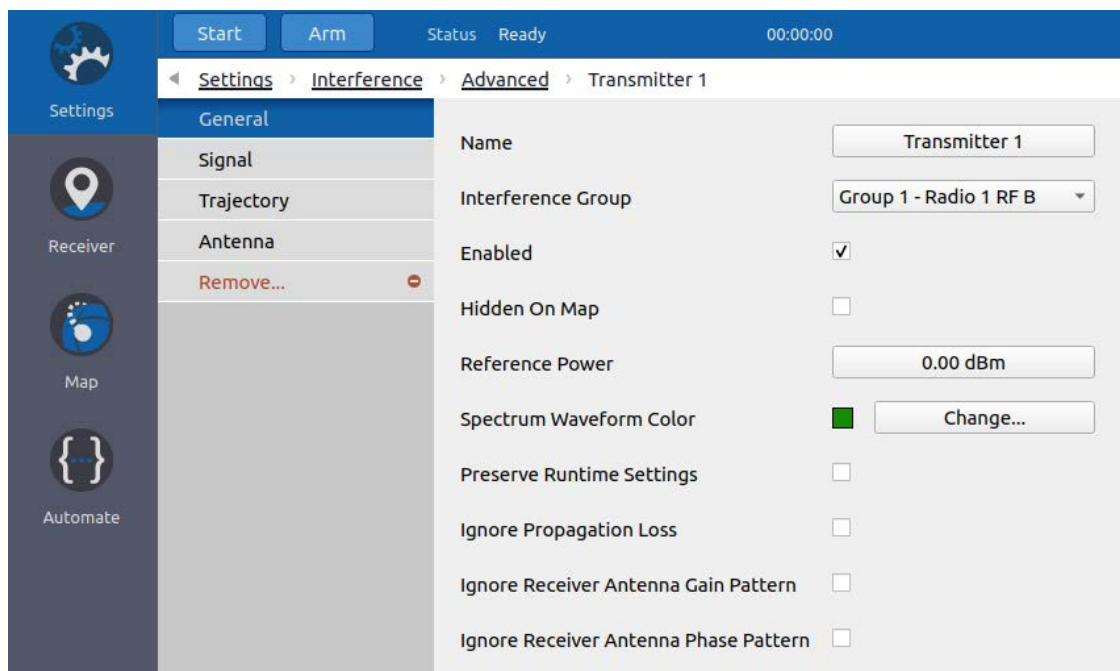

Click on the trajectory button to bring the trajectory page screen of the transmitter. Set the circular trajectory with the following attributes:

- » Center: 45 degrees north, 73 degrees west, 2 m altitude
- » Radius: 101 m
- » Speed: 1 m/s
- » Motion: Counterclockwise

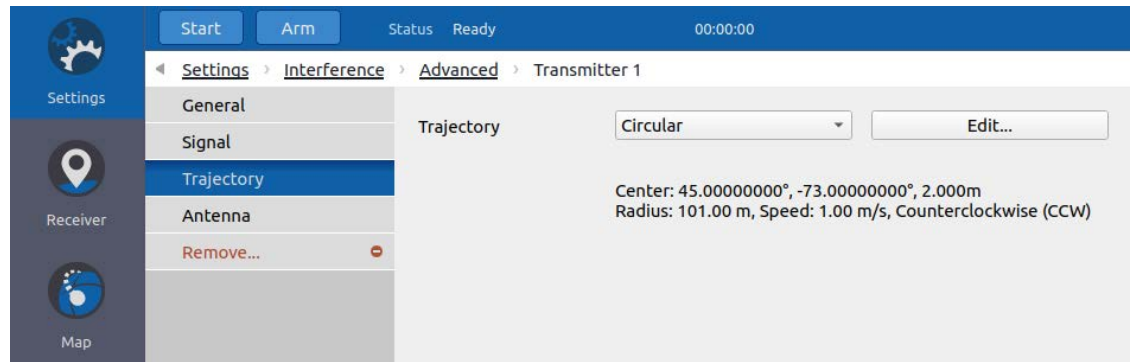

To create an interesting scenario, we will create a receiver trajectory that will cross the transmitter at close range. Set a receiver circular trajectory (see "[Circular](#)" on page 167) with the following attributes:

- » Center: 45 degrees north, 73 degrees west, 2 m altitude
- » Radius: 100 m
- » Speed: 1 m/s
- » Motion: Clockwise

Now the transmitter has a trajectory, but it is not transmitting anything. Lets add a Chirp signal.

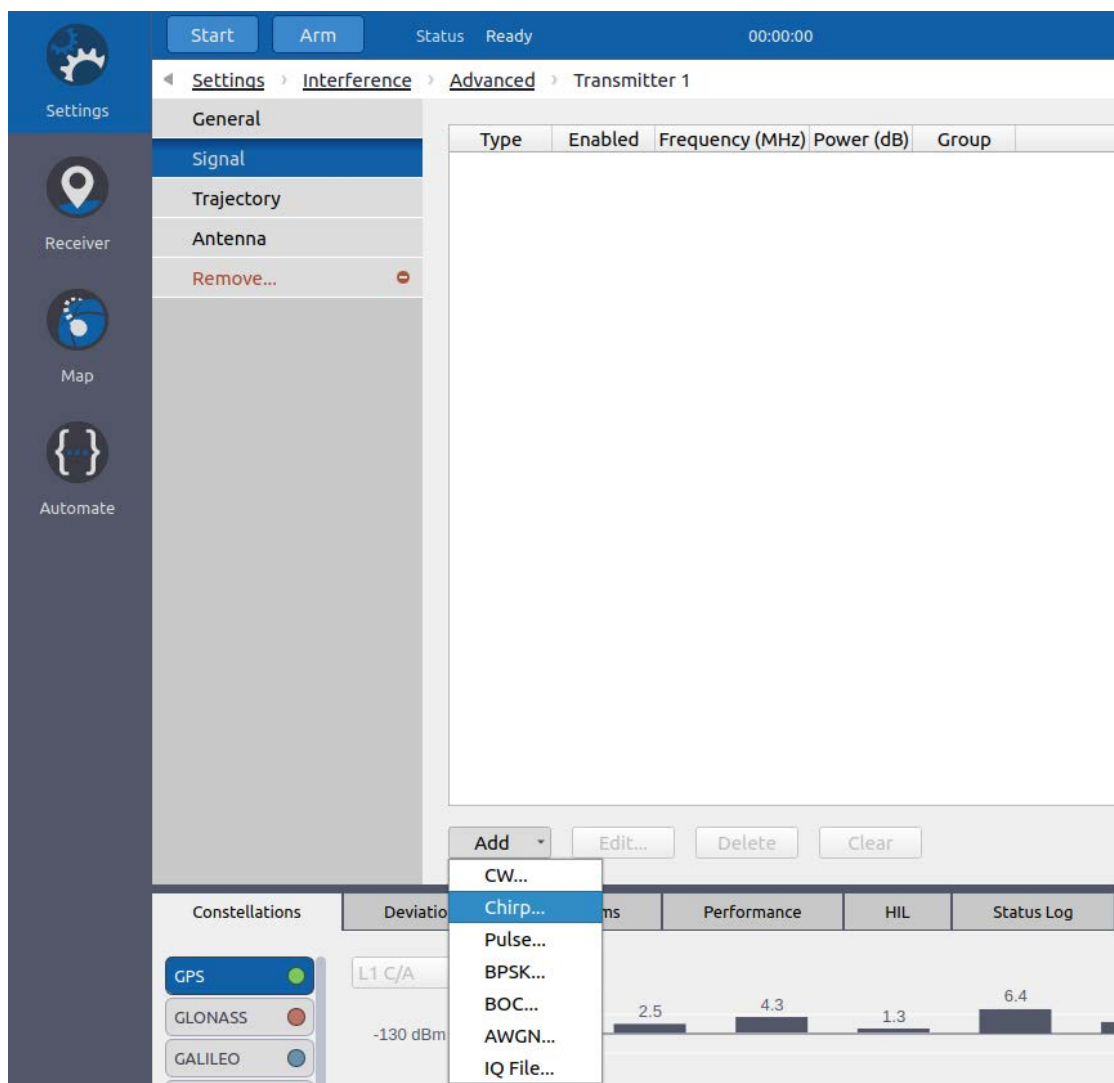

Change the chirp bandwidth to 10 MHz and the sweep time to 10 μ s. It is possible to add a signal with a different group than the transmitter, this allows a transmitter to jam different groups. To do so, you would have to uncheck "Use Default Group" and then change the signal group. For this example, let "Use Default Group" checked.

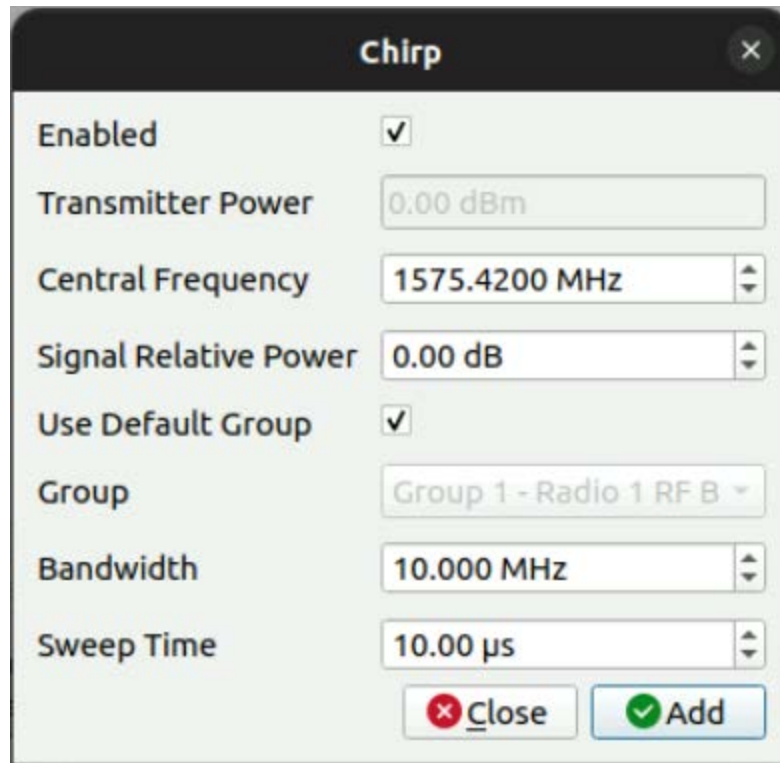

To add the chirp signal, click Add. You will see the signal added to the list in the main windows. We will not add another chirp signal in this example, so you can click Close.

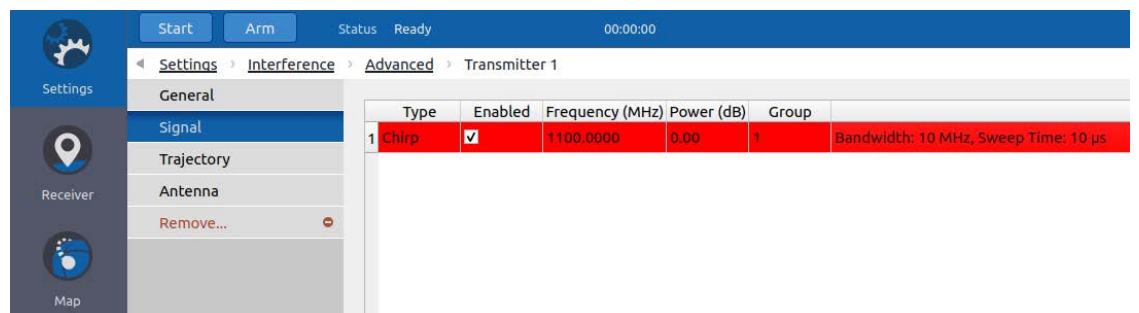
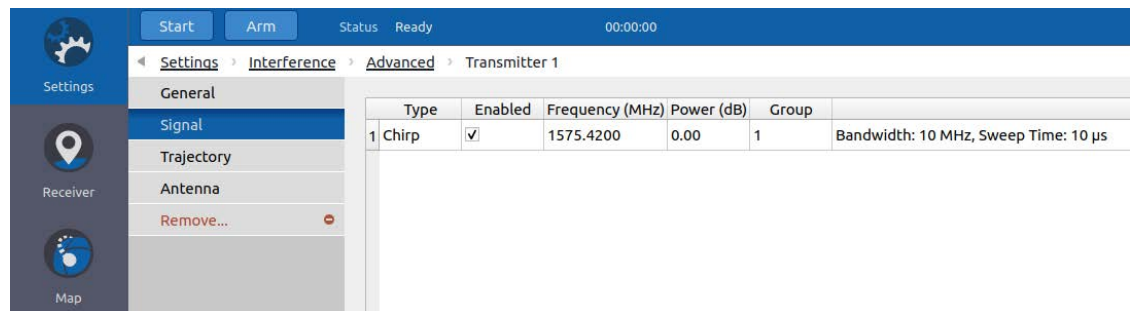



Note: When an interference signal is highlighted in red, it indicates that the signal cannot be modulated. There may be various reasons why a signal cannot be modulated. Below is a list of parameters that should be verified to identify the issue:

- Output Central Frequency
- Output Sampling Rate
- Interference Signal Central Frequency
- Interference Signal Bandwidth
- IQ File Sampling Rate

The power for the chirp is measured in dB. This is relative to the transmitter reference power defined in the General page. Let's go back in the General screen and reduce the power to -15 dBm. Also, uncheck the Enabled flag. We prefer not to have the jammer enabled when we start the simulation. This will allow some time for the receiver to track and lock on to the GPS signal. We will enable the jammer only after we have a lock on the receiver.

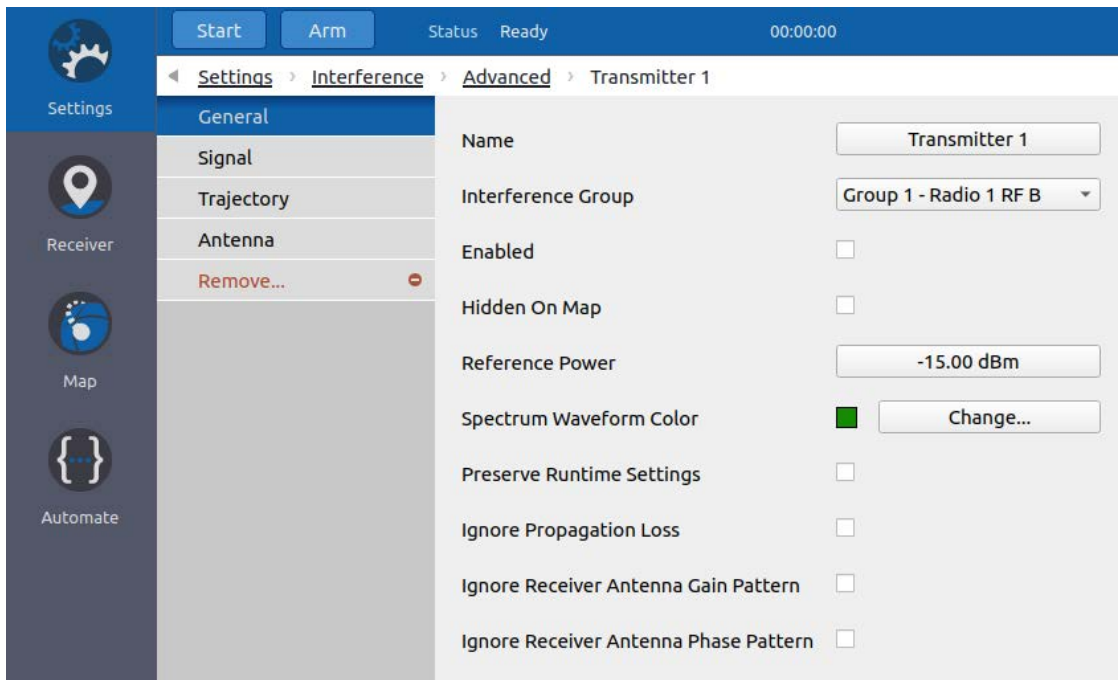

Parameter	Value / Control
Name	Transmitter 1
Interference Group	Group 1 - Radio 1 RF B
Enabled	<input type="checkbox"/>
Hidden On Map	<input type="checkbox"/>
Reference Power	-15.00 dBm
Spectrum Waveform Color	■ Change...
Preserve Runtime Settings	<input type="checkbox"/>
Ignore Propagation Loss	<input type="checkbox"/>
Ignore Receiver Antenna Gain Pattern	<input type="checkbox"/>
Ignore Receiver Antenna Phase Pattern	<input type="checkbox"/>

Let's start the simulator now and connect a [" Receiver" on page 205](#) in order to view the simulator, the receiver, and the transmitter in the [" Map" on page 208](#) tab. Depending on the performance of your receiver, it may take more or less time to get the receiver's solution. However, once you have it, the view in the map

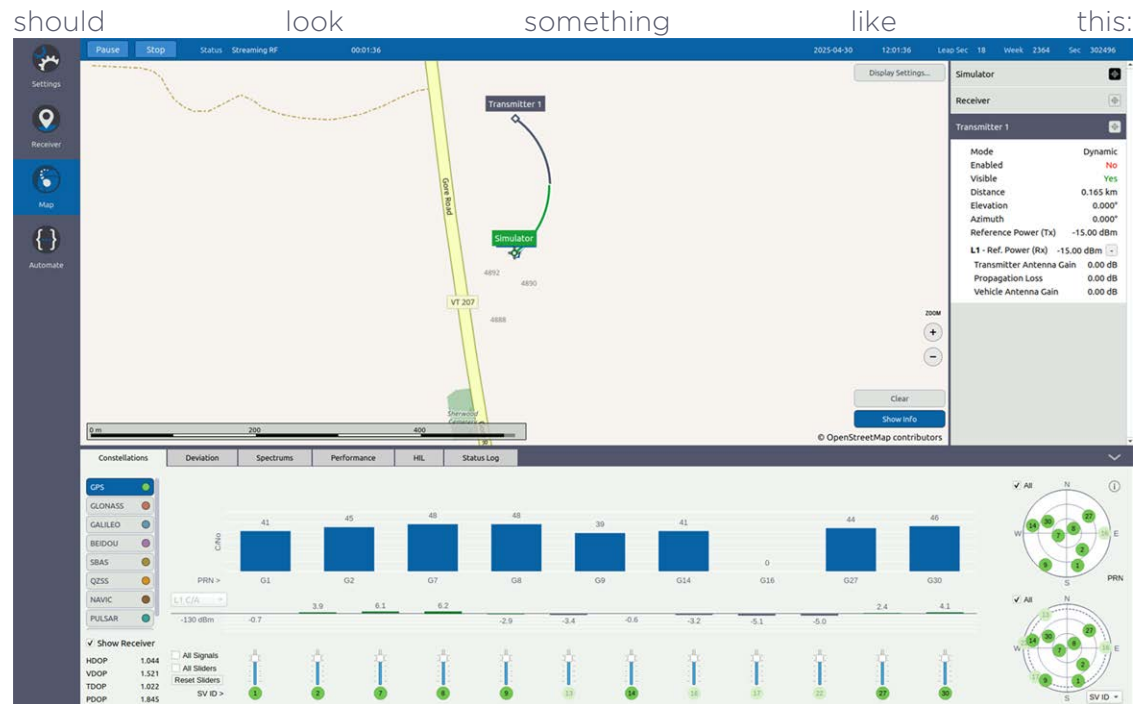

If you expand the transmitter information panel at the right of the map, you will see that the transmitter is not enabled. This means that the transmitter is not broadcasting RF; however, as you can see in the map, the transmitter is moving on a circular path.

In the information panel, you will also find 2 types of values for the Reference Power: Tx and Rx. The **Reference Power Tx** is the power level that you set in the General screen of the transmitter. The **Ref. Power Rx** is the perceived reference power at the receiver including the transmitter and receiver antenna patterns and the propagation loss. There are as many Reference Power Rx tabs as there are bands on the transmitter. If you click on the "plus" button at the right of a Reference Power (Rx), you will see more details for that band.

The transmitter can be visible or not by the receiver. If both receiver and transmitter altitude are inferior to 100km, Skydel uses radio horizon to determine the transmitter visibility. Otherwise, Skydel looks as though the transmitter is earth-masked.

In the spectrum subtab, you will see that the GPS signal is being transmitted on RF A; however, the spectrum for RF B should remain empty until you enable the transmitter.

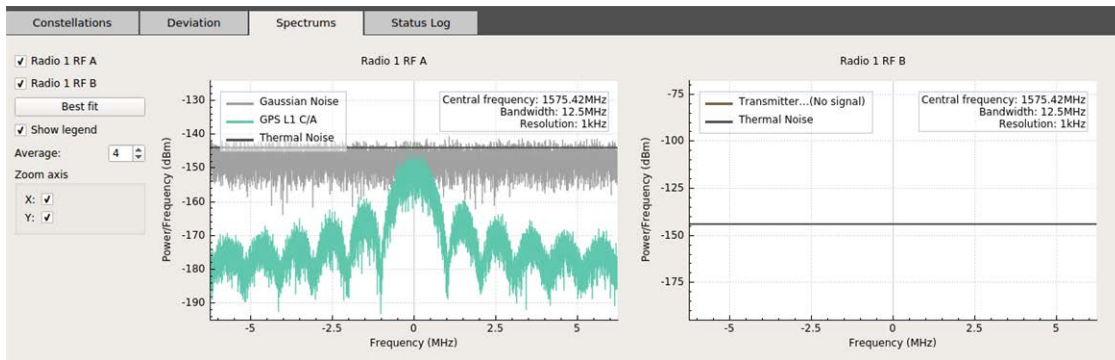

Now, go to the transmitter's General screen and enable the transmitter. You should now see the chirp appearing in the RF B spectrum.

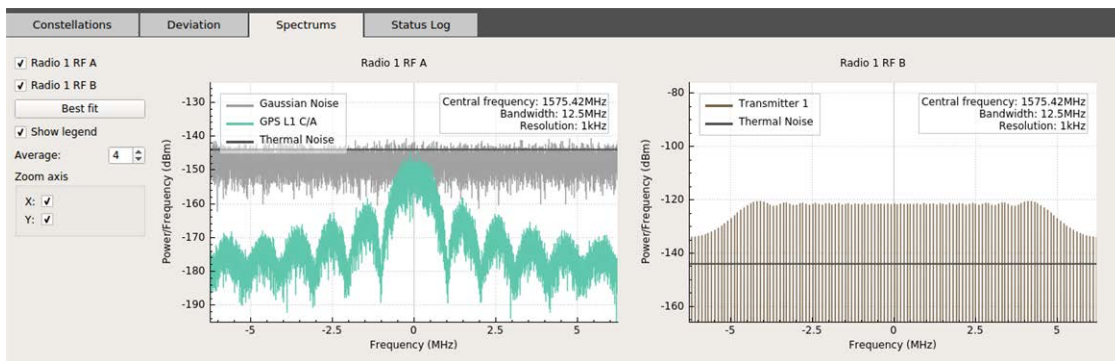

The simulator and the transmitter are both on a circular path and they will soon cross each others path within 1m range. When that occurs, you will see the spectrum power increase rapidly.

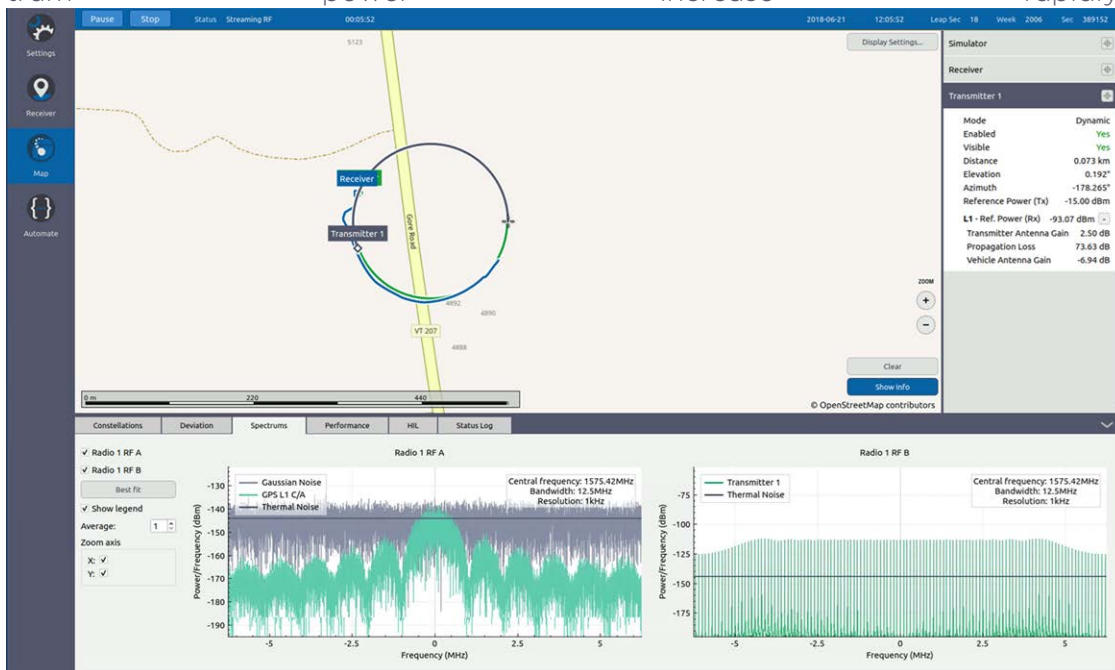

At this point, the receiver should experience some heavy jamming and you should have difficulty tracking the signal, as you can see in the Deviation subtab.

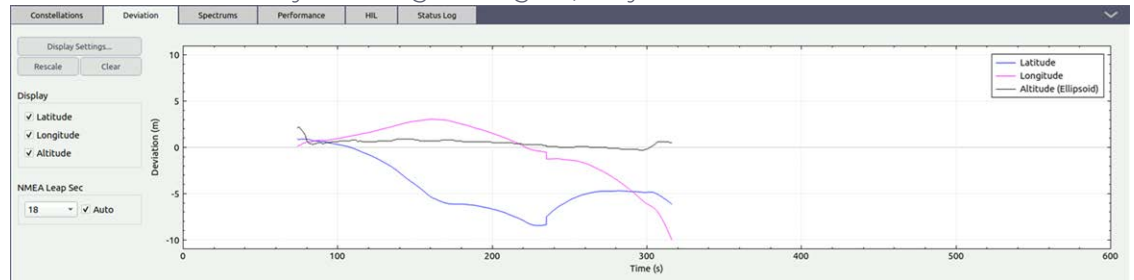

As the simulation proceeds and the transmitter fades away, the deviation quickly improves.

This simple dynamic transmitter tutorial was for a -15 dBm jammer. This is a very weak jammer. We leave it to the user to experiment with stronger jammers to see how the jamming radius increases the effect on the receiver being tested.



Tip: When you modify a transmitter while the simulation is running, all changes will be lost when you stop the simulation unless you check the option Preserve Runtime Settings in the transmitter's General screen. It is often easier to design complex waveforms at runtime in order to see the effect in the Spectrum subtab. While doing so, it is strongly recommended that you disconnect the RF output to protect your receiver.

3.14.1.3 IQ-File Jammer

The "IQ-File" jammer signal type enables the users to inject their own specific jammer waveform.

Type	Enabled	Frequency (MHz)	Power (dB)	Group	
1 IQ file	<input checked="" type="checkbox"/>	1575.4200	0.00	1	Relative IQ file; Filename: bpsk.iq

The waveform is stored in a binary file, containing a baseband IQ-Complex waveform. The format of the file is the same as the one described in the "IQ Files" on page 299 appendix.



Caution: The waveform selected can have a lower sample rate than the RF output where it will be injected. If so, the waveform selected will be upsampled in real-time during the simulation.

Power Level

The reference power level of the IQ-File signal is -130dBm, when the IQs of the file have a RMS value of 463.

For example, let's say that the IQ-File contains a CW waveform like this: I=463; Q=0; I=463; Q=0; I=463; Q=0; ...

When this file is used as a "IQ-File interference", and the transmitter is set to -130dBm, the output power will be -130dBm. However, it is important to understand that by default, RF outputs of interferences have a gain +40dB. So the actual RF signal power at the radio's connector will be -90dBm.

3.14.1.4 Multi-band Jammer

It is possible for a single transmitter to jam several bands. By default, all the signals added to a transmitter will jam the signal group defined in the transmitter general menu. To enable multi-band jamming, you have to uncheck "Use Default Group" in a signal "Add" or "Edit" dialog, then you can select the group you want the signal to jam.

Add Chirp Interference
✕

Enabled

Transmitter Power

Central Frequency

Relative Power

Use Default Group

Group

Bandwidth

Sweep Time

GPS is not included in yo

In the following example, the transmitter is set to jam the group 1, so all its signals will, by default, jam the group 1, but this Chirp signal is set to jam the group 2.

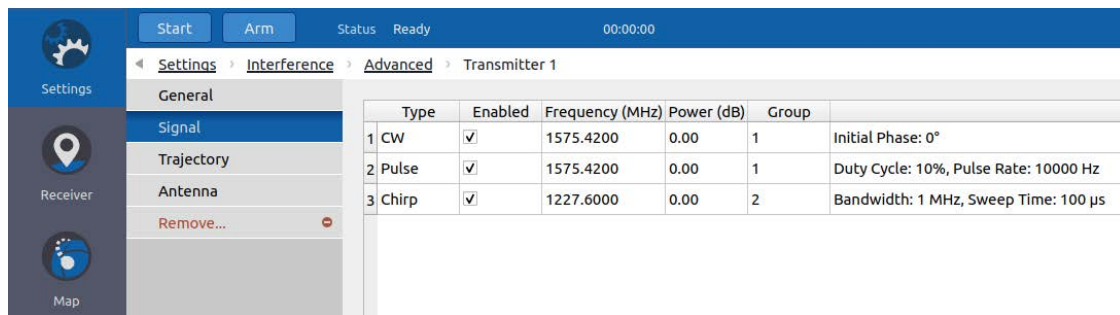

3.14.2 Advanced Spoofing

A spoofing scenario usually looks like this:

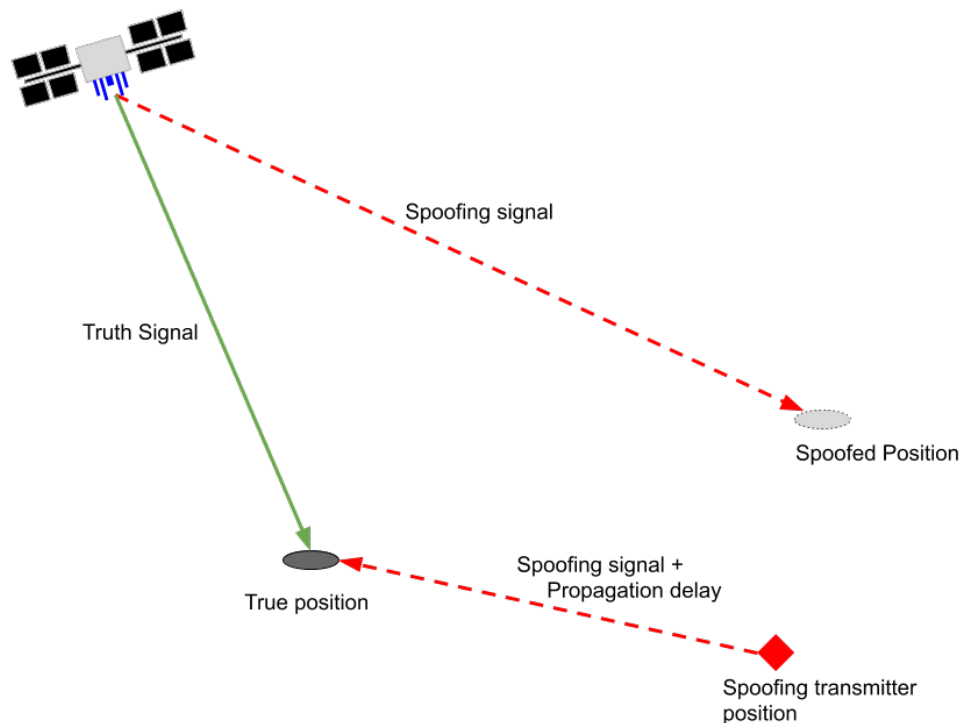

To summarize and agree on terminology:

- » A **receiver** receives a **truth signal**, from which it determines its **true position**.
- » The **receiver** will also receive a **spoofing signal** from a device located at a **spoofing transmitter position**.
- » The **spoofing signal** is a GNSS signal as it would be perceived by a receiver located in a **spoofed position**.

To achieve advanced spoofing in Skydel, at least two instances are required:

- » The **truth instance**, which manages the **truth signal**, the **true position** and the **spoofing transmitter position**.
- » The **spoofing instance**, which manages the **spoofing signal** and the **spoofed position**.

3.14.2.1 Spoofing instance

To start a spoofing instance, search for the shortcut **Skydel Spoofer** on your operating system or start the application in a command line shell with the **--spoofing** argument.

This instance is almost the same as a regular instance, with the following exceptions:

- » There is only one type of output: **Spoofer**.
- » The **Spoofer** output is assigned to an interference group that will be used in the main instance.
- » Only GNSS signals can be configured, these are the definition of the **spoofing signal**.
- » The Vehicle section defines the **spoofed position**.

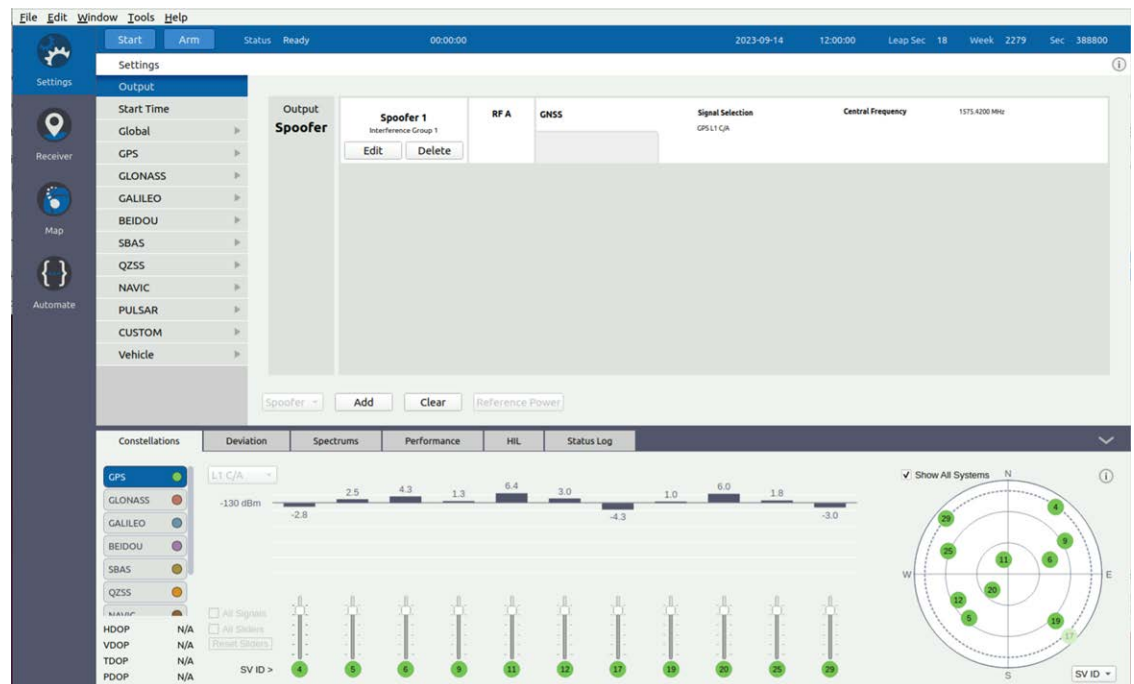

3.14.2.2 Truth instance

When the Advanced Spoofing feature is activated, you will see a new tab called Spoofers.

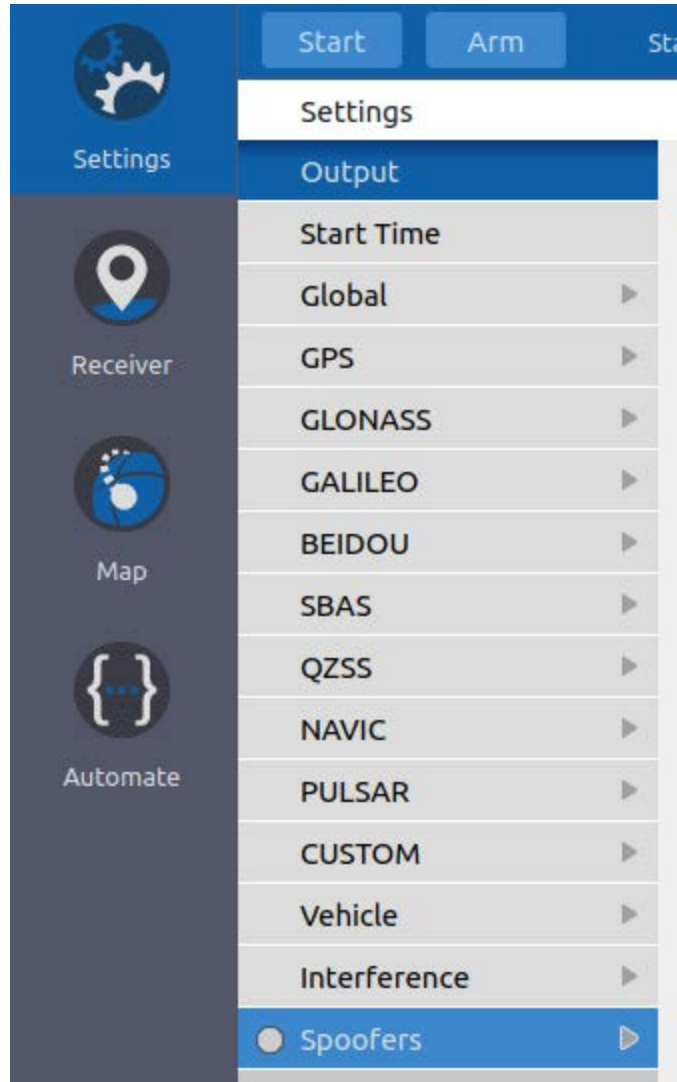

To add a **spoofing transmitter**, go into this tab and click on Add Spoofer... A **spoofing transmitter** is very close to a dynamic advanced jammer in its composition. We find the same General, Trajectory and Antenna sections.

In the Signal section, we have a summary of the spoofer's status. Here we can see and edit the **spoofing instance** address. The default address can be changed in Skydel's Preferences. Once connected, a table will show the **spoofing signals** detail.

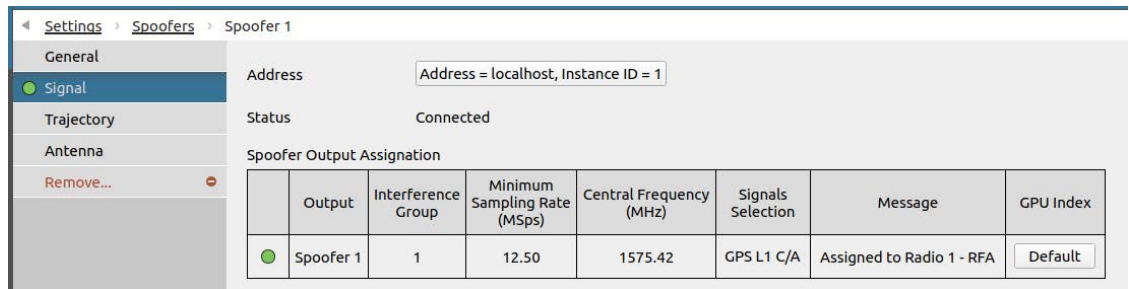

In the Spoofer's menu, next to the spoofer's name, a LED is showing its status:

- » Red → Connection to the **spoofing instance** could not be established or no signal is configured.
- » Orange → Only some of the spoofer's outputs are assigned to an output.
- » Green → Signals are all assigned to an output.

In the Settings menu, the LED next to the Spoofer submenu shows a global status:

- » Gray → The scenario does not contain any spoofers.
- » Red → At least one spoofer's status LED is red.
- » Orange → At least one spoofer's status LED is orange, none are red.
- » Green → All spoofer's status LED are green.

3.14.2.3 Additional Jamming + Spoofing Resources

Here are some additional resources that can help you when working with Jammers and Spoofer's:

- » [Advanced GNSS Jamming with a GSG-8](#)
- » [Adding Jamming and Spoofing to a GNSS Simulation](#)

3.15 Receiver

You can access the Receiver tab by clicking this button:

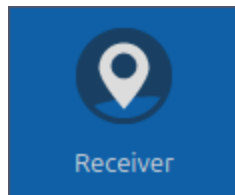

Once your simulation is running, you can switch to the Receiver tab to look at the output of an NMEA receiver. Start by clicking the Connect button and choosing your receiver from the list of available ports. It is possible to modify the baud rate, data bits, parity, stop bits and flow control of the serial port used by the receiver.



Resources: For detailed information and instructions on logging NMEA data, please see ["NMEA Serial Port Logging"](#) on page 306.



Note: Linux users must be in the "dialout" group to connect to the receiver. See Dialout Group in the ["Software Configuration: Linux Ubuntu"](#) on page 290 section.

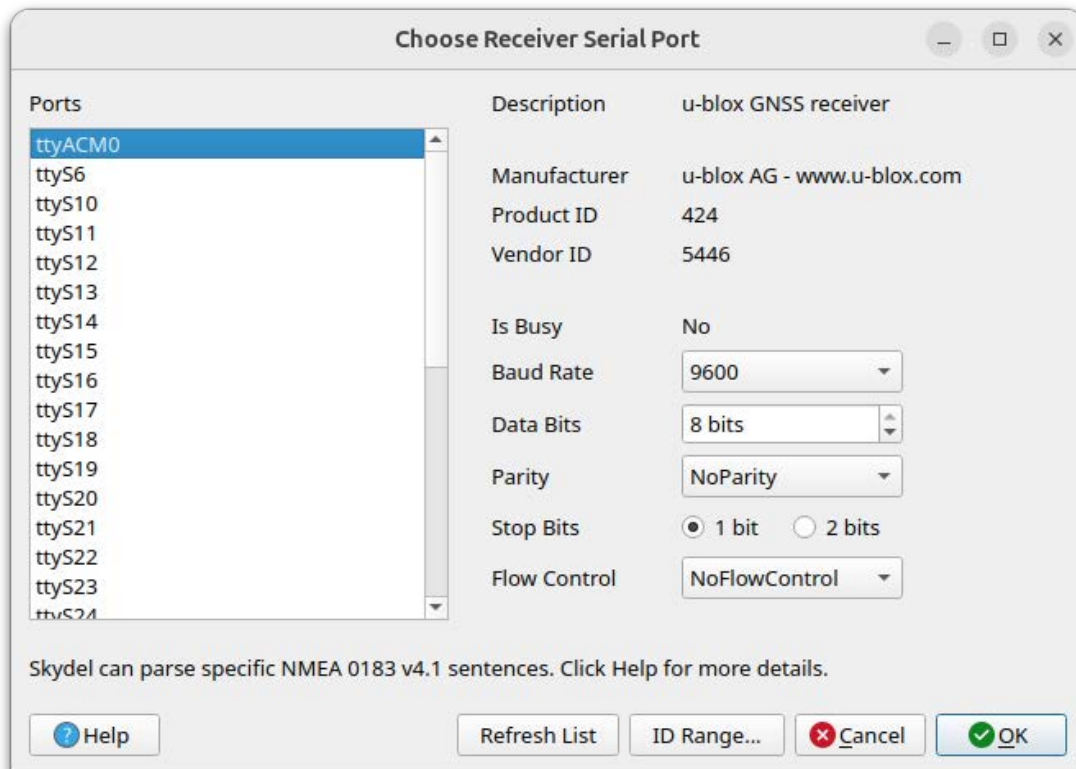

Skydel is optimized for NMEA 0183 Version 4.1. Click on the Help button to get further information about which sentences can be decoded. Click OK to close the dialog box and connect with your GNSS receiver. You should then see a stream of NMEA data appear. The receiver's NMEA data is decoded in real-time and Skydel will display the receiver time, position, DOP, sky view, and C/No for each satellite.

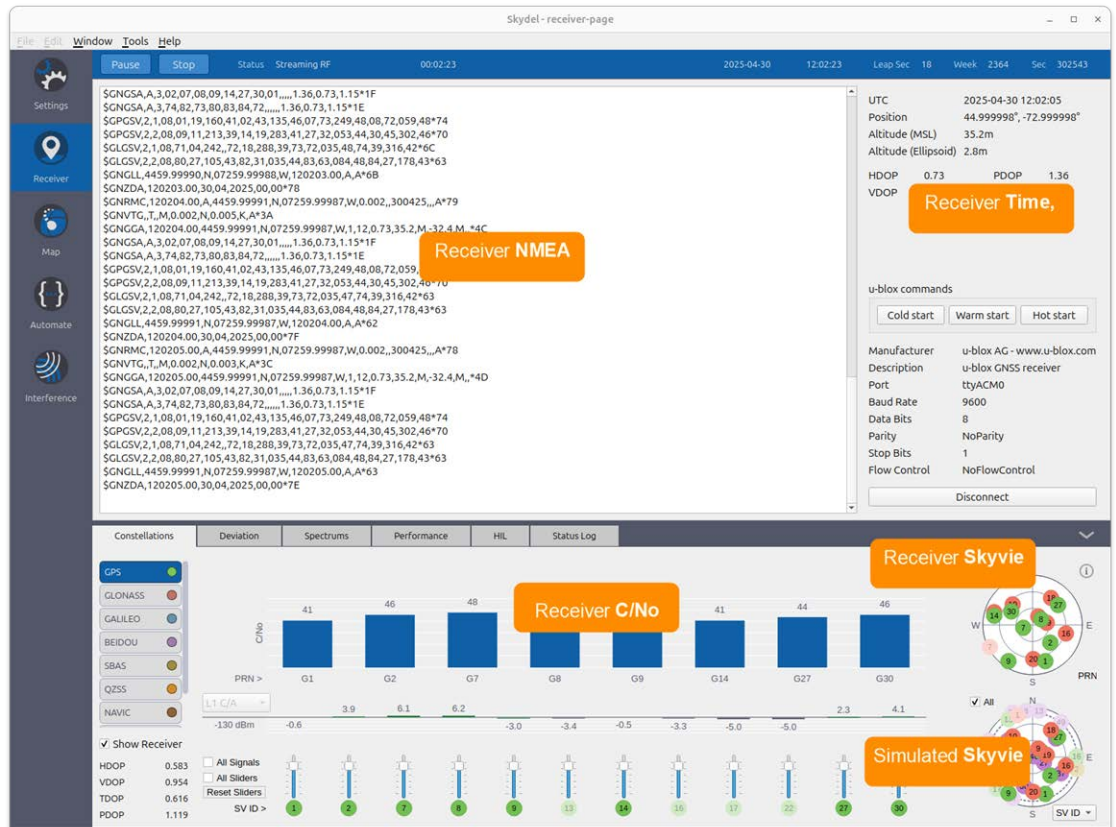

When Skydel is connected to a receiver, a new checkbox appears in the Constellation subtab enabling you to display the receiver. When this checkbox is checked, the Constellation subtab will split horizontally. The upper half of the subtab will display information about the receiver (as decoded from the NMEA feed): C/No bars and sky view. The lower half of the subtab displays the usual information about the simulator.

The C/No values are displayed for the selected constellation.

The simulator sky view (lower) and the receiver sky view (upper) are not always identical. For example, some satellites below the elevation mask will appear in the receiver sky view only when the receiver has decoded the almanac from the navigation message which can take several minutes.

The Deviation subtab will show traces only if the receiver has a navigation solution. If the receiver does not have a solution, or does not send GGA sentences, Skydel will not display the receiver deviation.

Controls to display the deviation graph are provided on the left-hand side of the subtab; deviation graph options can also be accessed by right-clicking the deviation graph to bring up a contextual menu.

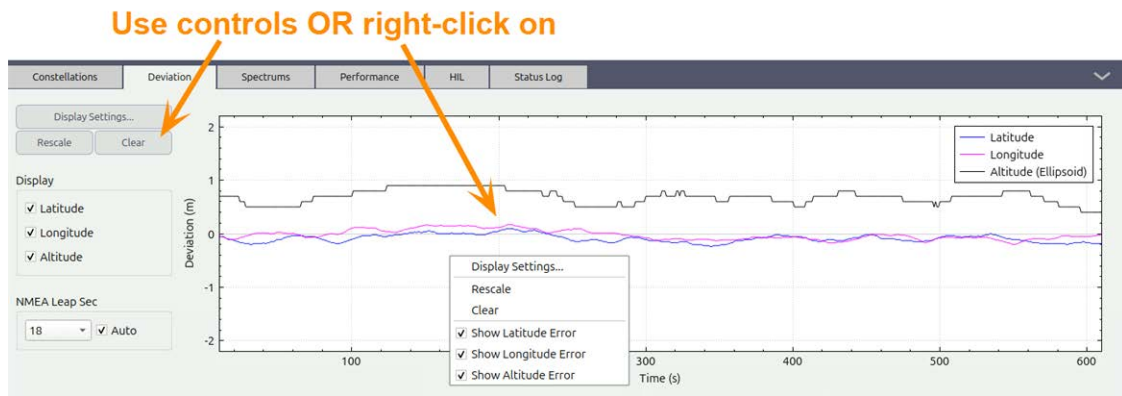

The Display Settings let you change the receiver’s leap seconds. This parameter is very important for accurate calculation of deviations. Skydel runs with GPS time while the receiver sends NMEA data using UTC time. To align the receiver data with the simulated data, the value for the receiver’s leap seconds must match what the receiver is currently using. This value may require adjustment if a Leap Seconds Future (LSF) event (see ["Settings: Start Time" on page 73](#)) occurs during the simulation.

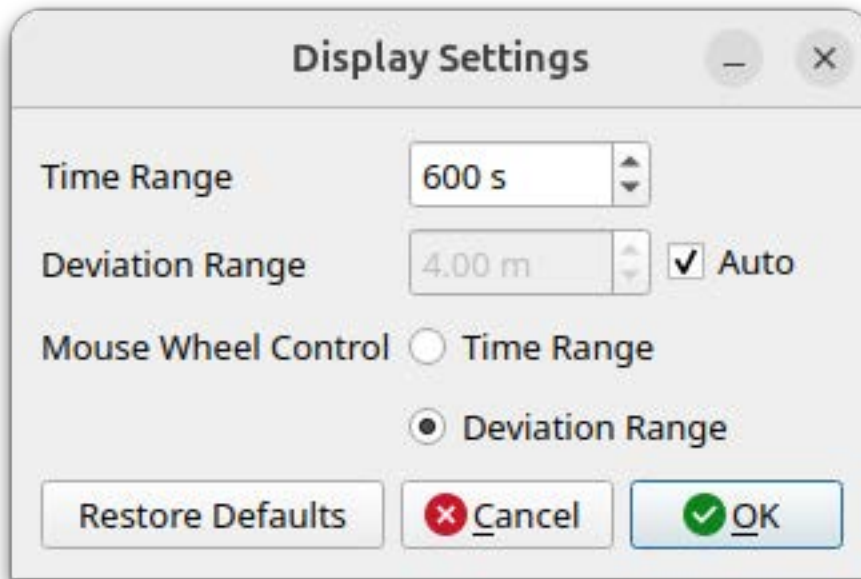

3.16 Map

You can access the Map tab by clicking this button:

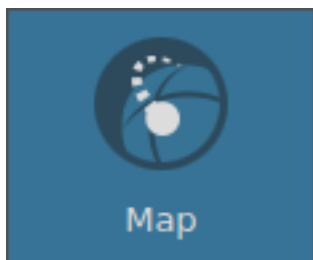

The Map tab contains the map on the left side and the information panel on the right side. It simultaneously displays the simulated position and the receiver's position. If Skydel is not connected to a receiver, or if the receiver does not have a navigation solution, the receiver position will not appear. The information panel on the right uses accordion styling. You can click on an item to open or collapse the details.

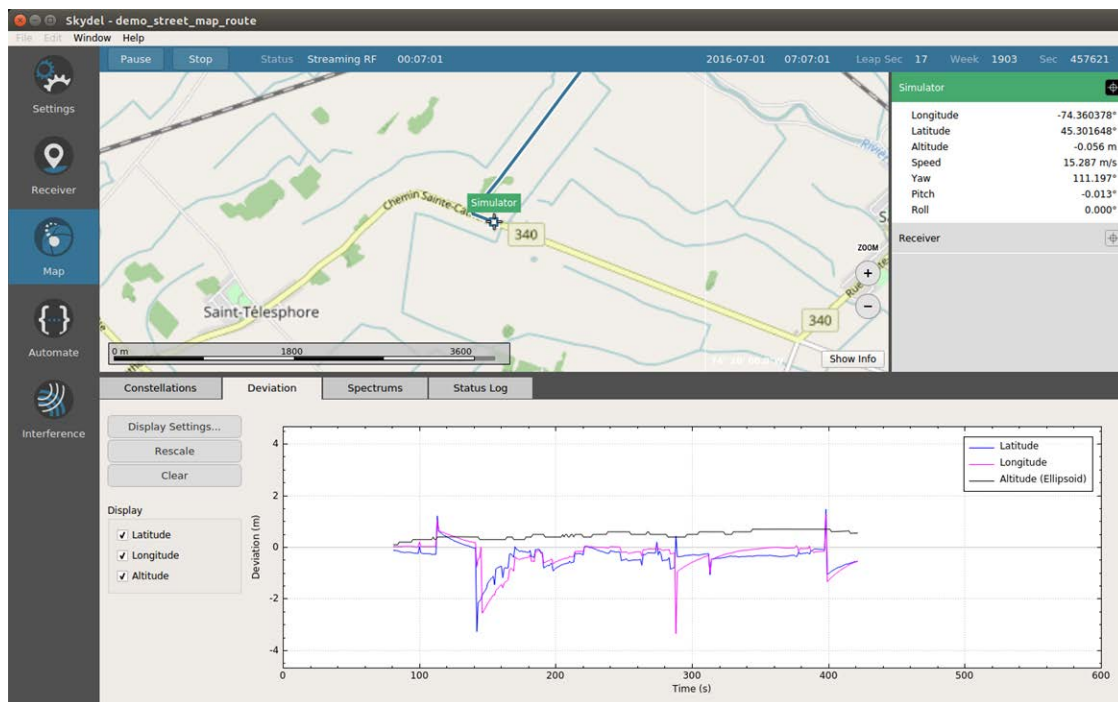

Each item in the information panel has a target state button. When clicked, the corresponding position stays centered on the map. If you pan the map, the target button will reset automatically.

Simulator	
Longitude	-74.360378°
Latitude	45.301648°
Altitude	-0.056 m
Speed	15.287 m/s
Yaw	111.197°
Pitch	-0.013°
Roll	0.000°

Receiver	

← TARGET BUTTON

3.17 Automate

Automate includes the following subsections: "[Application Programming Interface \(API\)](#)" on the facing page, and "[Skydel Script](#)" on page 219.

Skydel was built around the **Command Design Pattern**, which means that all actions (either from GUI or Remote control) are sent to the Engine using Commands. The commands are processed by the engine exactly the same way whether they come from the GUI or remote program. If your simulation is working via GUI, it will work exactly the same via the API.

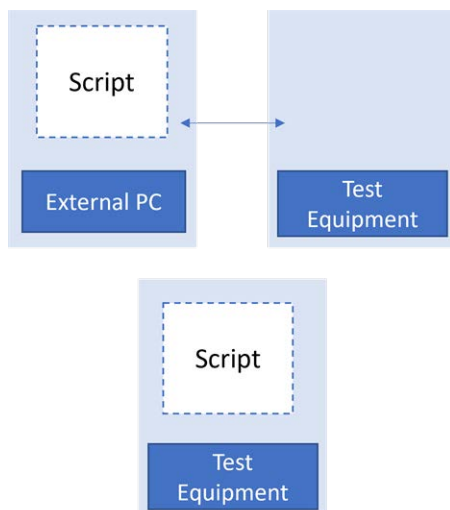
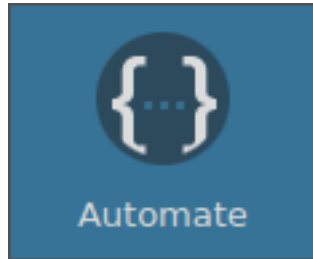

Figure 3-23: Script can run from external PC or on the test equipment itself

You can access the Automate tab by clicking this button:



The Automate tab helps you get started using the Skydel API and writing your own scripts to control Skydel.

3.17.1 Application Programming Interface (API)

There are several reasons why you might want to use the Skydel API.

- » More control over the simulation while it runs, such as:
 - » changing the value of pseudorange offsets during the simulation;
 - » changing the power of interference during the simulation;
 - » changing the power of satellites during the simulation;
 - » changing the downlink data more frequently.
- » To control Skydel as part of an automated test system
 - » no human interaction with Skydel is required when using the API

Skydel provides API clients in the following languages:

- » Python
- » C#
- » C++

The Skydel API is fully featured and provides complete control over the Skydel Engine. In fact, the Skydel GUI communicates with the Skydel Engine using this same API. Therefore, anything that can be done through the Skydel GUI can also be done via the Skydel API.

The Documentation.txt file in the Skydel-SDX/API folder provides a complete list of commands with a short description.

As you make changes to your configuration, a list of commands will be displayed in the Automate tab. For example, in the image below, the line highlighted in blue is for a "[Message Modification](#)" on page 111.

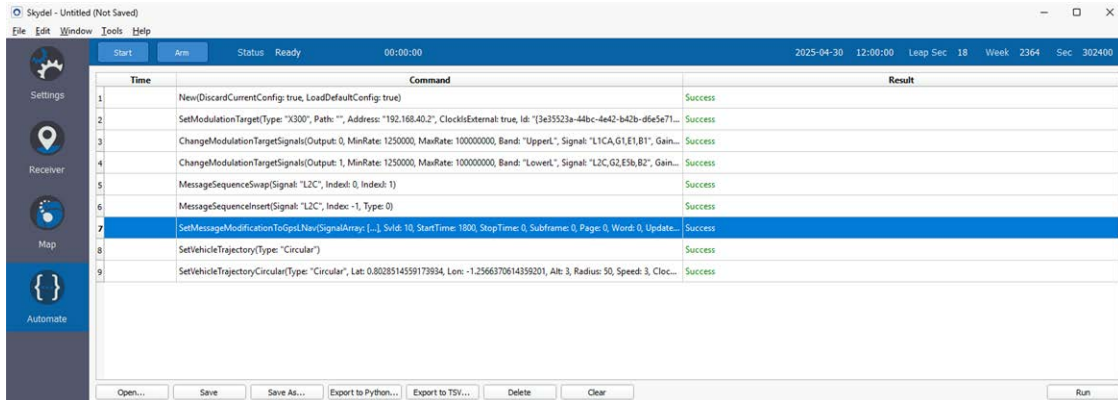

Time	Command	Result
1	New(DiscardCurrentConfig: true, LoadDefaultConfig: true)	Success
2	SetModulationTarget(Type: "X300", Path: "", Address: "192.168.40.2", ClockIsExternal: true, Id: "{3e3523a-44bc-4e42-b42b-d6e5471...")	Success
3	ChangeModulationTargetSignals(Output: 0, MinRate: 1250000, MaxRate: 100000000, Band: "UpperL", Signal: "L1CA_G1E1_B1", Gain...	Success
4	ChangeModulationTargetSignals(Output: 1, MinRate: 1250000, MaxRate: 100000000, Band: "LowerL", Signal: "L1C_G2E5_B2", Gain...	Success
5	MessageSequenceSwap(Signal: "L2C", Index: 0, Index: 1)	Success
6	MessageSequenceInsert(Signal: "L2C", Index: -1, Type: 0)	Success
7	SetMessageModificationToGpsNav(SignalArray: [...], Svid: 10, StartTime: 1800, StopTime: 0, Subframe: 0, Page: 0, Word: 0, Update...	Success
8	SetVehicleTrajectory(Type: "Circular")	Success
9	SetVehicleTrajectoryCircular(Type: "Circular", Lat: 0.8028514559173934, Lon: -1.2366370614359201, Alt: 3, Radius: 50, Speed: 3, Cloc...	Success

When double-clicking a line, additional information about the command will be displayed.



Set Modification To Gps Navigation Message

JSON Object
Documentation

```
{
  "CmdName": "SetModificationToGpsNavigationMessage",
  "CmdUuid": "{7f5ea1dc-e00a-47d0-af58-7437cc47af11}",
  "Prn": 10,
  "StartTime": 1800,
  "StopTime": 0,
  "SubFrame": 0,
  "Page": 0,
  "Word": 0,
  "UpdateParity": false,
  "Modification": "-110-----XX-X",
  "Id": "{7a2a0118-02a2-4ded-9d0b-6d2dba92f735}"
}
```

Close

The JSON Object tab is the command interpreted by Skydel.

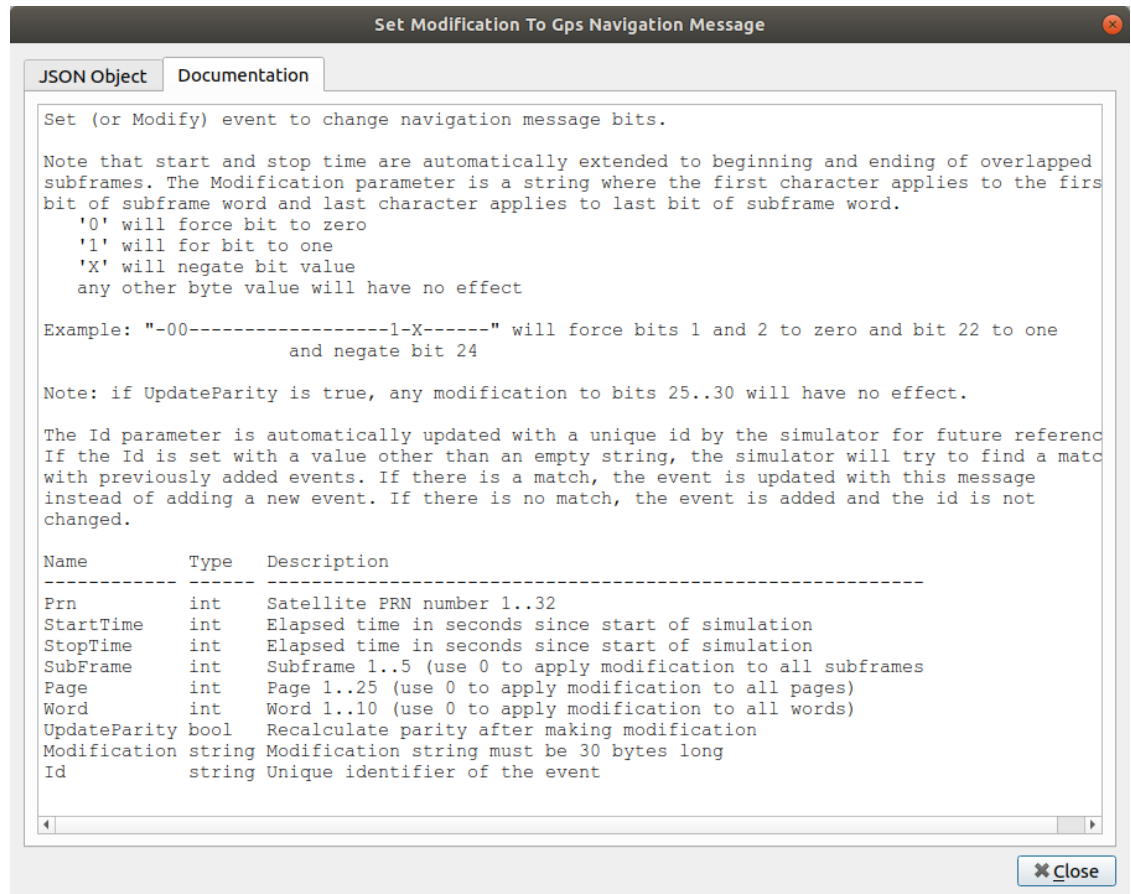

Figure 3-24: The Documentation tab describes each parameter for the command.

When you set the message modification in the GUI and click the Add button, the GUI sends a request as a JSON Object to the Skydel command engine to be executed and logged in the Automate page. In computer science, encapsulating a request as an object is called the command design pattern.

The Skydel API client is an external library that will enable you to send requests as JSON objects to Skydel through a TCP/IP connection. It doesn't matter to Skydel whether a command comes from the GUI or via a remote program.

Some Skydel functionalities could not be implemented using the Command design pattern and will not appear in the Automate tab. For example, "[Vehicle Trajectory](#)" on page 217 or using the "[Hardware-in-the-Loop \(HIL\)](#)" on page 228 will not appear in the Automate list. But that doesn't mean that you can't use these functions through the API.

3.17.1.1 Python

When you install Skydel on a Linux system, the skydelsdx library is automatically installed. Python scripts can be run from anywhere.

For Windows users, the library can be found in the Skydel-SDX/API/Python/skydelsdx folder. You may run `setup.py` to make the library accessible from anywhere. If you choose not to do so, you should save your scripts in the parent folder and execute them from there. The Python interpreter will find the library in the skydelsdx sub-folder.

The Skydel Python API is open source and can be modified, copied, or reused any way that you want. However, Safran recommends using the API “as is” (as much as possible) so that migration to future releases of Skydel will be easier. Skydel is constantly evolving; Safran sometimes adds new functions or capabilities that require modifying existing features and the corresponding API. To mitigate impacts to your scripts, each Skydel version comes with release notes that include a list of modified, removed, and added API methods.

You will find several Python script examples in the Skydel-SDX/API/Python folder.

The “Export to Python” feature is, by far, the easiest way to learn how to automate Skydel.

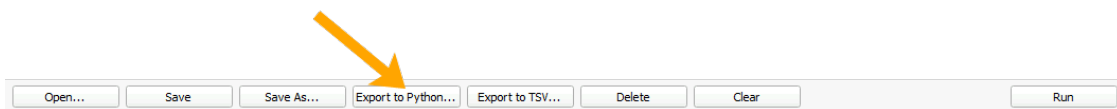

When you click the Export to Python button, Skydel will generate a Python script that will replicate the content of the Automate list.



Note: Before you export your Python script, you can delete any lines in the list that you don't want exported to your script.

The following is an example of a Python script generated by Skydel:

```

Open my_first_script.py Save
~/Documents/Skydel5DX/API/Python
#!/usr/bin/python
# This Python script has been generated by Skydel

from datetime import datetime
from datetime import date
from skydelsdx import *
from skydelsdx.commands import *

sim = RemoteSimulator(True)
sim.connect()

sim.call(New(True, True))
sim.call(New(True, True))
sim.call(SetModulationTarget("N310", "", "192.168.40.2", True, "{4c638446-5955-4d9b-b2fb-902ed0fe4a87}"))
sim.call(RemoveAllModulationTargets())
sim.call(ResetDefaultConfiguration())
sim.call(SetModulationTarget("N310", "", "192.168.40.2", True, "{3342b251-af8d-4cb2-81d9-5032a5bb52d8}"))
sim.call(ChangeModulationTargetSignals(0, 2500000, 7680000, "UpperL", "", 60, False, "{3342b251-af8d-4cb2-81d9-5032a5bb52d8}", None))
sim.call(SetVehicleTrajectory("Circular"))
sim.call(SetVehicleTrajectoryCircular("Circular", 0.785398, -1.27409, 2, 50, 3, True, 0))
sim.disconnect()

```

In the above example, `sim` is an instance of the `RemoteSimulator` class. This class offers a high-level API that converts simple function calls into JSON objects. The class handles the transmission of those JSON objects to Skydel and interprets the results for you.

Before you can transmit requests to Skydel, you must first connect. The `connect()` method accepts 2 parameters: Skydel IP address and instance id (see "[Command Line Options](#)" on page 27). If no values are provided to the method, the defaults are "localhost" and "0". Skydel is listening on port 4820 + id. If Skydel was started with instance id 2, it would be listening on port 4822. When connected, Skydel will display a robot emoji at the left end of the dashboard.



The connection is followed by a list of calls that you can easily recognize in the Automate list. The first call is to create a new configuration in Skydel.

```
sim.call(New(True))
```

The `call` method is generic. It can send any command: `New`, `SetModulationTarget`, etc. The parameter is a command object. This line can be replaced by 2 lines. First you create the command, and then you execute the call.

```
cmd = New(True)
sim.call(cmd)
```

It is sometimes useful to proceed this way so that you can interrogate the command object after the call returns. Some commands will be updated as a result of the call method. For example, if you add a message modification without providing a unique identifier, the result will contain a unique identifier assigned by Skydel that you can re-use to update the message modification in the future.

The call method is blocking. This means that it will stop the script execution until Skydel returns a result (pass or fail). This blocking mechanism is referred to as a synchronous call. There is another method called `post` which is not blocking and this calling mechanism is referred as asynchronous. When using the asynchronous strategy, it is important to synchronize from time to time with the `wait` method.

```
cmd = New(True)
sim.post(cmd)
# do something else...
sim.wait(cmd)
```

Regardless of how the command was sent to Skydel (`call` or `post`), it will appear in the Automate tab.



Tip: When you run your script for the first time, or if you need to debug it, clear the command list in the Automate tab and monitor the command results.

If you become a heavy API user, you may notice that it takes some time to process hundreds or thousands of commands to change the settings. The reason is that Skydel updates the user interface after every command and redraws the sky view and power bars above the sliders. To avoid this, you can instruct Skydel to hold off GUI updates while it updates the settings.

```
sim.call(LockGUI())
# Update many settings
sim.call(UnlockGUI())
```

Skydel will display a message in the title bar to signal when the GUI is locked.



You are encouraged to look into the skydelsdx library to better understand how it works. Also, the examples provided with Skydel will demonstrate how you can define custom vehicle trajectories, send real-time trajectories (hardware-in-the-loop), control interferences, etc.

3.17.1.2 C++

The Skydel C++ API is located in Skydel-SDX/API/Cpp/sdx_api.

The C++ examples are located in the sdx_examples folder. To build the examples, use the CMakeLists.txt file in the parent folder.

The principles of the C++ library are the same as with the ["Python" on page 214](#) library. The syntax differences are minor and looking at the various examples should get you started quickly.

3.17.1.3 C#

The Skydel C# API is located in Skydel-SDX/API/CSharp/SdxApi.

The C# examples are located in the SdxExamples folder. To build the examples, use the SdxExamples.sln file in the parent folder.

The principles of the C# library are the same as with the ["Python" on page 214](#) library. The syntax differences are minor and looking at the examples should get you started quickly.

3.17.1.4 Vehicle Trajectory

Trajectories can be created through the API. You can create tracks (see ["Track Playback" on page 168](#)) as well as routes (see ["Vehicle Simulation" on page 175](#)). They differ in that tracks are defined with time and position pairs, while routes are defined with speed and position pairs.

For detailed explanations about the geographic coordinate system used in Skydel, please consult the ["Six Degrees of Freedom" on page 165](#) section.

Track

To create a track with the API, use the following command sequence:

```
sim.call(SetVehicleTrajectory("Track"))
sim.call(SetVehicleType("Ground / Water"))
sim.beginTrackDefinition()
# push time and position pairs
sim.endTrackDefinition()
```

There are multiple methods that you can use to push time and position pairs:

- » `pushTrackEcef`: push time and position in ECEF reference system;
- » `pushTrackEcefNed`: push time, position (ECEF), and attitude (relative to NED local frame);
- » `pushTrackLla`: push time, latitude, longitude and altitude (ellipsoid);
- » `pushTrackLlaNed`: push time, latitude, longitude, altitude, and attitude (relative to NED local frame).



Note: Time is the number of milliseconds (ms) into the simulation (elapsed time).

If the attitude is not provided, Skydel will automatically calculate it. The yaw (heading) will go along the route. The pitch will go up and down based on the altitude variation and the roll is fixed to 0°.

Route

To create a route with the API, use the following command sequence:

```
sim.call(SetVehicleTrajectory("Route"))
sim.beginRouteDefinition()
# push speed and position pairs
sim.endRouteDefinition()
```

The route vehicle simulation supports only ground vehicles for the moment. Therefore, you don't need to specify the vehicle type and you can't specify the attitude either. The attitude is automatically calculated by Skydel. The yaw (heading) will go along the route. The pitch will go up and down based on the altitude variation and the roll is fixed to 0°.

To push speed and position pairs, you have the choice between two methods:

- » `pushRouteEcef`
- » `pushRouteLla`

The speed is expressed in meter per second (m/s).

Retrieve vehicle information

It is possible to retrieve information about the vehicle using the remote API. The available information are:

- » The position in the ECEF frame
- » The attitude (Yaw, Pitch, Roll)
- » The speed in km/h
- » The heading
- » The odometer

Please refer to the `example_vehicle_info.py` python script, the `run-ExampleVehicleInfo` C++ function or the `RunExampleVehicleInfo` C# function for a complete example.



Resources: [How to use StudioView for Building Trajectories](#) ↗
[Converting a Motion-Based Trajectory into a Waypoint Trajectory](#) ↗

3.17.2 Skydel Script

Sometimes you require a fast and simple way to automate tasks and you don't want to use a programming language to do so. Skydel allows you to record commands as a Skydel script from within the GUI and to replay these commands. Let's take an example to illustrate how it works.

Step 1

"Create New Configuration" on page 49.

Step 2

Switch to the Automate tab and clear the list

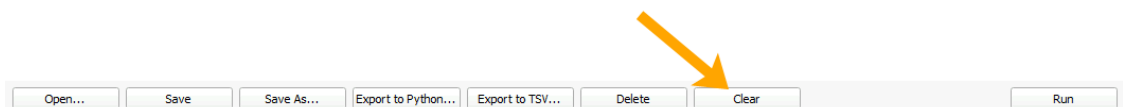

Step 3

Switch to the Settings tab and make some changes to the settings such as:

Change the simulation start time (see "[Settings: Start Time](#)" on page 73).

Change the ionospheric model (see "[Atmosphere](#)" on page 79). If you switch back to the Automate tab, you should see the changes in the list.

If you switch back to the Automate tab, you should see the changes in the list.

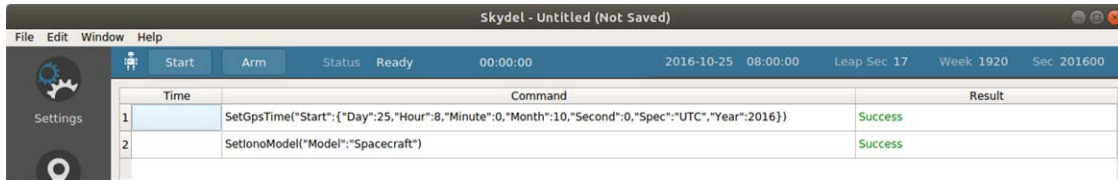

Time	Command	Result
1	SetGpsTime("Start":{"Day":25,"Hour":8,"Minute":0,"Month":10,"Second":0,"Spec":"UTC","Year":2016})	Success
2	SetIonoModel("Model":"Spacecraft")	Success

Step 4

Save the script as `my_first_script` or some other filename that you will remember.

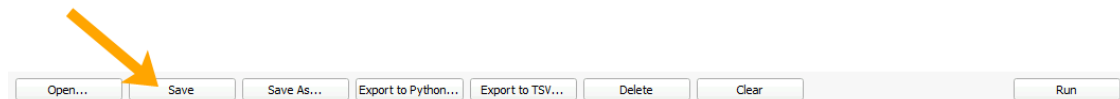

By default, your script will be saved in the Skydel-SDX/Automate folder. The extension of the file is `.sdxscript`.

Step 5

Quit Skydel and restart it. You can also simply create a new configuration and clear the Automate list once again.

Step 6

Switch to the Automate tab and open the script that you just saved (`my_first_script`).

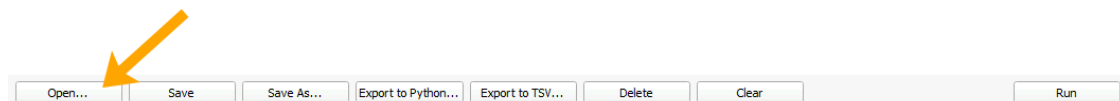

You will notice the Automate list is now showing the list of commands that you saved in `my_first_script` but the difference is in the Result column: it is empty. That's because the script is loaded but never executed. At this point, your simulation start time and ionospheric model are unchanged.

Step 7

Run the script

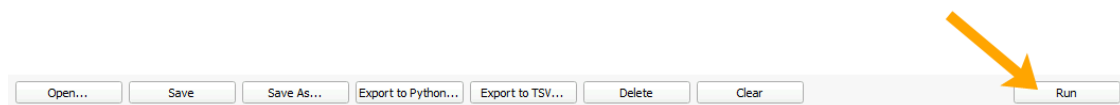

The script execution will only last a few milliseconds and you will see the Result column filled with "Success" mentions. You can now check that your simulation start time and ionospheric models are set according to your script.

Scripts can be more complex and can record commands while the simulation is running. Commands executed during the simulation are timestamped and will occur at the exact same time during the replay. In the image below, you can see that timestamps are recorded after the simulation starts and continue to be recorded until it stops.

Time	Command	Result
1	RemoveModulationTarget("Id":{"10aa3de2-8664-4c23-ae03-2694ce99a78a"}")	Success
2	SetModulationTarget("Address":"","ClockisExternal":true,"Id":{"6dc31ff6-6562-4abf-9cc8-d355e1877763"},"Path":"","Type":"NonERT")	Success
3	ChangeModulationTargetSignals("Band":"UpperL","Id":{"6dc31ff6-6562-4abf-9cc8-d355e1877763"},"MaxRate":10000000,"MinRate":12500000,"Output":0,"Signal":"L1CA")	Success
4	0:00:00.000 Start()	Success
5	0:00:01.724 SetSatPower("OtherSatsFollow":false,"PowerOffset":-1,"Prn":12,"System":"GPS")	Success
6	0:00:01.746 SetSatPower("OtherSatsFollow":false,"PowerOffset":-2,"Prn":12,"System":"GPS")	Success
7	0:00:01.770 SetSatPower("OtherSatsFollow":false,"PowerOffset":-3,"Prn":12,"System":"GPS")	Success
8	0:00:01.810 SetSatPower("OtherSatsFollow":false,"PowerOffset":-4,"Prn":12,"System":"GPS")	Success
9	0:00:01.832 SetSatPower("OtherSatsFollow":false,"PowerOffset":-5,"Prn":12,"System":"GPS")	Success
10	0:00:01.848 SetSatPower("OtherSatsFollow":false,"PowerOffset":-6,"Prn":12,"System":"GPS")	Success
11	0:00:01.864 SetSatPower("OtherSatsFollow":false,"PowerOffset":-7,"Prn":12,"System":"GPS")	Success
12	0:00:01.888 SetSatPower("OtherSatsFollow":false,"PowerOffset":-8,"Prn":12,"System":"GPS")	Success
13	0:00:02.114 SetSatPower("OtherSatsFollow":false,"PowerOffset":-9,"Prn":12,"System":"GPS")	Success
14	0:00:02.230 SetSatPower("OtherSatsFollow":false,"PowerOffset":-10,"Prn":12,"System":"GPS")	Success
15	0:00:02.310 SetSatPower("OtherSatsFollow":false,"PowerOffset":-9,"Prn":12,"System":"GPS")	Success
16	0:00:03.600 Stop()	Success

If you export this list as a "Python" on page 214 script, you will see how commands are executed from a Python script while the simulation is running.

As an exercise, you can create a script where you change the satellite power during the simulation (move the power slider up and down). When you will replay this script, you will notice that the slider moves at the same moment.

3.17.2.1 Export To TSV

You also have the option to Export s script to TSV (tab-separated values).

Click the "Export to TSV..." button to export information about your Skydel automation script to a TSV file.

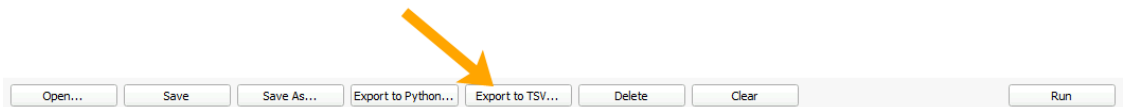

This file includes the same details displayed in the Automation tab, along with additional data such as the UTC time and GPS time when each command was executed.

3.18 Basic Interference

You can add basic jamming waveforms to the simulation via the Settings - Interference menu. If your license includes the Advanced Jammer feature, you can also add basic jamming waveforms via the Settings - Interference - Basic menu. These jamming signals will be generated and output by all ports that output the GNSS signals. When saving a configuration, these interference waveforms will be retained in the saved configuration.

To add a waveform, click the Add button on the Interference tab. Select the type of waveform that you would like to add. For this example, we will use CW.

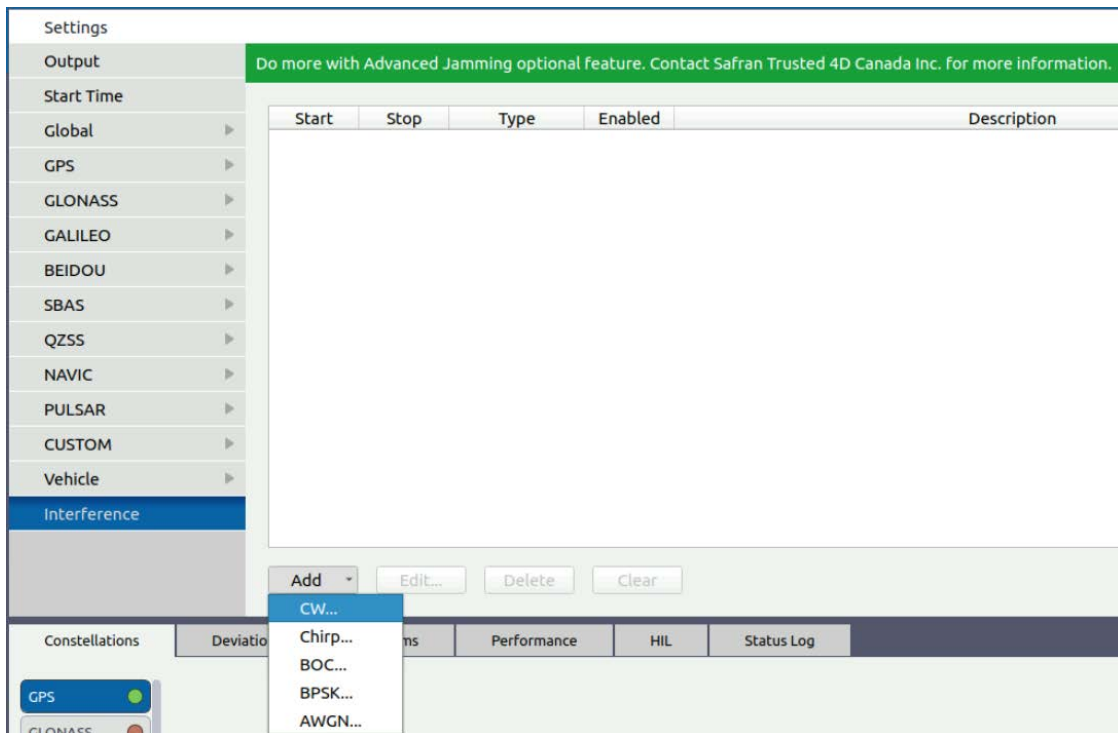

You can adjust the settings in the dialog box that appears. The start and stop times are in the “hh:mm:ss” format and are relative to simulation time.

Add CW Interference ✕

Start

Has Stop Time

Stop

Central Frequency

Relative Power

The power is relative to the nominal output power (-50 dBm at the TX port for the Ettus X300 SDR, -110 dBm after the 60 dB attenuators) — see "[Reference Power Level](#)" on page 69. This power level can be thought of as the “jammer to signal” ratio. But this is only true if the global "[Signal Power](#)" on page 97 and code specific signal power are both 0 dB.

For example, if the signal power is configured as shown below and the interference is set to 30 dB, the interference will be 30 dB stronger than the C/A signals, and 33 dB stronger than the P Code signals.

◀ [Settings](#) ▶ Global

- Atmosphere ▶
- Earth Orientation
- Propagation Model
- Logging
- Signal Power
- Synchronize Simulators
- SV Data Update

Global Offset

Dynamic Range Offset

Signal Offset

GPS	GLONASS	Galileo	BeiDou	SBAS	QZSS	NavIC	PULSAR
GPS L1 C/A	<input style="width: 50px;" type="text" value="0.0 dB"/>					GPS L1ME	<input style="width: 50px;" type="text" value="-1.5 dB"/>
GPS L1C	<input style="width: 50px;" type="text" value="4.5 dB"/>					GPS L2ME	<input style="width: 50px;" type="text" value="-1.5 dB"/>
GPS L2C	<input style="width: 50px;" type="text" value="1.5 dB"/>					GPS L1MR	<input style="width: 50px;" type="text" value="-1.5 dB"/>
GPS L1 P-Code	<input style="width: 50px;" type="text" value="0.0 dB"/>					GPS L2MR	<input style="width: 50px;" type="text" value="-1.5 dB"/>
GPS L2 P-Code	<input style="width: 50px;" type="text" value="0.0 dB"/>					GPS L5	<input style="width: 50px;" type="text" value="4.5 dB"/>

Reference power -131.5 dBm (Minimum RF signal strength at 5 degrees of elevation)

Signal Strength Model

If you increase the Global Signal Power to +5 dB, the interference will be 25 dB stronger than the C/A signals. This is because the global offset increases the power level of the signals, but not that of the interference.

Once you have added the interference, it will show up in the Interference list.

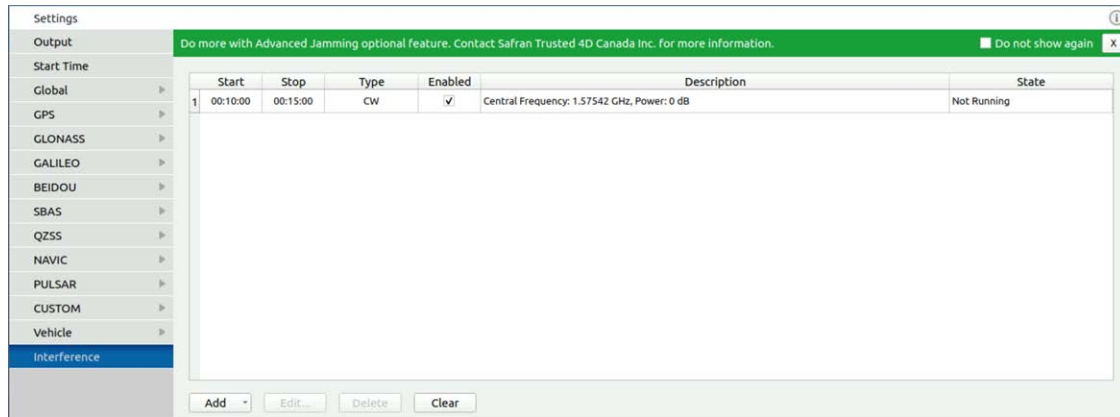

The State column indicates Not Running if the simulation is not running. During the simulation, there are a handful of states that can be indicated for each interference signal:

- » **Inactive** - The interference is off. The current time is not between the start and end times;
- » **Active** - The interference is on;
- » **Out of Range** - The interference is off. The signal doesn't fit within any of the RF output frequency ranges.

If everything is set up correctly, you should see the interference become active during the assigned times.



Caution: When you configure multiple outputs (see "[Settings: Output](#)" on page 63) with the same Fc or with overlapping bands, and when the interference is enabled for that Fc, the interference is added to each RF output. When you combine the outputs with the RF combiner, you sum the interferences. The interference wavefronts are not necessarily aligned.

3.19 SNMP Support

An SNMP agent and a MIB can be found on [Learn Safran Navigation Timing's Github](#). It is provided with an installation script for Ubuntu.

Thanks to this agent, you can probe and control Skydel through variables such as the **isRunning** variable. This variable is an integer equal to 1 if a Skydel simulation is currently running, 0 otherwise. Setting it to 1 will start the simulation while setting it to 0 will stop it.

More details can be found in the documentation provided with the agent. An application is also available detailing how to customize the sub agent for your specific needs.



Resources: [Safran-Skydel SNMP Agent and MIB File](#)↗

BLANK PAGE.

CHAPTER 4

Hardware-in-the-Loop (HIL)

This section will describe the Hardware-in-the-Loop concept and provide HIL setup instructions.

The following topics are included in this Chapter:

4.1 Hardware-in-the-Loop (HIL)	228
4.2 Time Reference	229
4.3 HIL Sequence Diagram	230
4.4 Code Example	232
4.5 Latency	235
4.6 HIL Graph	239
4.7 Sending Positions in Advance	253

4.1 Hardware-in-the-Loop (HIL)

In a HIL setup involving the Skydel GNSS simulator, we often have the following elements (or concepts).

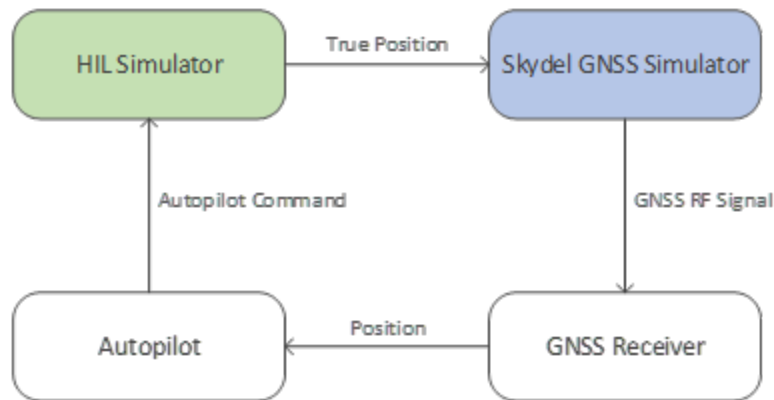

Figure 4-1: HIL Setup

There are many possible variations. For example, the Autopilot could be a human interacting with a virtualized dashboard, but the concept often remains the same. The key principle is that the loop is often closed, and the true position is not known in advance. Instead, the true position of the vehicle is determined as the scenario progresses and fed in real-time to the Skydel GNSS Simulator.

In this setup, the Skydel GNSS Simulator receives the true vehicle trajectory in real-time and generates the GNSS RF signal accordingly. A GNSS receiver tracks the signal and computes its position. This position is sent to a navigation system, such as the autopilot in this example. The autopilot analyzes the position and sends commands to correct the vehicle trajectory. Those commands are processed by the HIL simulator, which emulates the effect of such commands on the true position.

For this setup to work properly, the integrator must carefully consider the following questions:

- » What is the acceptable latency between the HIL Simulator input (Autopilot Command) and the Skydel GNSS Simulator output (GNSS RF Signal)?
- » How is this latency budget shared between the HIL Simulator, the Skydel GNSS Simulator, and the link connecting them?
- » How are synchronization and the clock system handled?
- » Can the HIL Simulator and the Skydel GNSS Simulator use a common clock source?
- » At which rate can the HIL Simulator update the true position of the vehicle?

- » What position data will be available (time, position, velocity, attitude, angular velocity, etc.)?



Note: Make sure the HIL option is included in your software license (see "License Feature List" on page 29).

4.1.1 Additional HIL Resources

Here are some additional resources that can help you when working with HIL.

- » [Advanced Hardware-in-the-Loop \(HIL\) FAQ](#)
- » [Setting a Timing Reference for Synchronizing GNSS Simulations \(SecureSync\)](#)

4.2 Time Reference

The following drawing details the suggested integration of the HIL Simulator and Skydel Simulator.

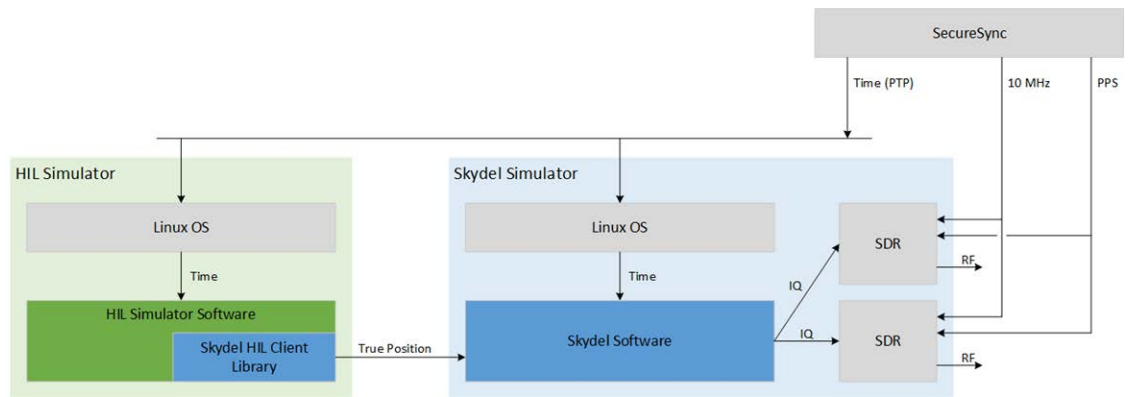

Figure 4-2: SecureSync Time Reference

Module	Description
SecureSync	The network time server ensures the operating system on the HIL Simulator, and the Skydel Simulator are tightly synchronized within hundreds of microseconds. It also provides the 10MHz reference clock and PPS signal to the software-defined radios (SDRs).

Module		Description
Linux OS		Linux is recommended over Windows for real-time applications. Linux should be configured to use Precision Time Protocol (PTP) to synchronize the clock with the SecureSync.
Skydel		The GNSS simulation software receives the true position and generate the corresponding GNSS RF signal in real-time. Skydel adds a deterministic latency which is set in the software preferences. It may be required to change the settings in the preferences to achieve the desired latency.
HIL Simulator Software		The HIL Simulator is responsible for sending the true vehicle position to the Skydel simulator. The HIL Simulator must timestamp the data, hence the need to have a common clock source to minimize jitter and drift between the HIL Simulator and the Skydel Simulator.
Skydel HIL Client		The Skydel HIL Client is a library providing a simple API. It is highly recommended to use this library and not try to reimplement the communication protocol with Skydel. The Skydel HIL Client requires an Ethernet connection and uses a mix of TCP/IP for most commands and UDP for true position data. The Skydel HIL Client adds latency which is mainly defined by the Ethernet connection. The combination of the HIL Simulator and the Skydel HIL client is sometimes referred to as the HIL Client in this document.
SDR		The software defined radios must receive the PPS and 10MHz signals from the same time source, as Skydel will use their internal clock to drive the simulation.

It is possible to deviate from the suggested integration, but investing in a common clock source to discipline all subcomponents will make the system easier to understand and easier to optimize.

4.3 HIL Sequence Diagram

The most critical part in any HIL system is to get the synchronization right. The following timing diagram shows the logical steps for precise control of the Skydel synchronization with an external PPS source.

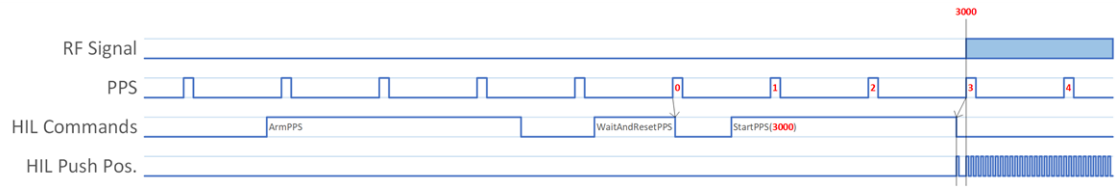

Figure 4-3: HIL Sequence Diagram

There are 5 phases in the starting sequence:

Arm the system

The ArmPPS command initializes the hardware. The execution may take a while and will vary depending on the hardware. Some radios take only a couple of seconds while others, like a Wavefront system, will take longer because it must perform a phase calibration.

Choose a PPS reference (PPS zero)

The WaitAndResetPPS command does exactly what it says: it will wait for the next PPS, reset the PPS counter in Skydel to zero and return. When this command returns, you know that you are just a few microseconds or milliseconds after PPS zero.

If your setup is using a SecureSync to discipline your operating system clock as shown in the previous section, it should be aligned with the PPS. When the WaitAndResetPPS returns, you can read the precise system clock on Linux and round down to the previous second. This is the system time associated with PPS zero.

Program the delayed start using PPS zero as the timing reference

The StartPPS command will start the GNSS RF signal stream at a precise time, always relative to the PPS zero. When multiple Skydel instances are controlled by a primary (main) Skydel instance, make sure the StartPPS is set in the future to cover at least 2 full PPS cycles which are required by Skydel to synchronize all the secondary (worker) instances. Multiple instances are used in many scenarios: multiple vehicles, spoofer, Wavefront nodes, etc.

The StartPPS command will return control to the caller a few milliseconds before the defined time. This will allow time to send the initial position before the simulation starts. Without the initial receiver position, Skydel can't make the necessary calculations to determine the propagation delays from the GNSS satellites to the receiver position and will not start properly.



Note: StartPPS uses the Streaming Buffer size defined in the Skydel preferences as the amount of time before the actual RF streaming starts. For example, with a streaming buffer of 200ms, the StartPPS function will return control to the caller 200 ms before the RF starts streaming. It is not recommended to play with this preference.

Push the initial position before it starts

The first position should be sent before the beginning of the simulation. For this reason, the StartPPS command returns before the specified time. When it returns, it is the right time to send the initial position. Skydel needs the starting position to initialize and compute pseudoranges, visible satellites, etc.

Push all subsequent positions at regular intervals

Assuming the operating system clock is disciplined by the same clock source as the Skydel simulator, it is possible to use the system clock to determine when it is time to start the loop to send the vehicle position. The position should be sent at a high rate to minimize position errors between samples. A rate of 200-250 Hz is a typical compromise between extrapolation errors and available system resources.

Each position update, including the initial position, must include the elapsed time. The elapsed time is not relative to PPS zero, it is relative to the beginning of the RF signal transmission. In the timing sequence previously shown, the simulation starts at PPS 3. At that precise moment, the elapsed time is zero. All HIL positions pushed should include the elapsed time since that moment. The initial push should have the elapsed time set to zero. If the HIL push rate is 200Hz, new positions should be pushed at 5, 10, 15 ms and so on.

4.4 Code Example

To simplify the integration of Skydel in user programs, it is strongly recommended to use the libraries provided. These libraries are open source so they can be inspected by users. Although they are open source, these libraries are developed by Safran, and not by the open-source community. The libraries are available in Python, C and C#. For simplicity, the code provided as examples in this document are all in Python, but they can easily be translated into C or C# as the command names are the same.

In this example, the Python code will initialize the Skydel simulator to synchronize with a PPS source and steer the vehicle on a simple circular trajectory. It is

assumed that the example program is running on a Linux computer and the system clock is disciplined by the same source as the Skydel simulator, as previously explained in the hardware setup.



Note: We will skip some details, such as some function definitions, just to cover the main concepts. The complete Python source code, as well as a C++ and C# example, can be found in the API examples folder.

The first step is to connect with the Skydel instance.

```
sim = skydelsdx.RemoteSimulator()
sim.setVerbose(True)
sim.connect("localhost")
```

The verbose option can be helpful to help diagnose potential issues. The “localhost” should be replaced with the IP address where Skydel is running. A local host can be used only if this Python script runs directly on the Skydel host computer.

```
sim.call(SetVehicleTrajectory("HIL"))
sim.call(SetHilTjoin(20))
sim.setHilStreamingCheckEnabled(True)
```

The script sets the vehicle trajectory to Hardware-In-the-Loop (“HIL”). It is assumed that Skydel scenario is already configured (signals selection, output selection, etc.). After setting the HIL trajectory, the Tjoin parameter must be set for the current scenario. The unit for Tjoin is in milliseconds. You will find below in this document a whole section dedicated to this parameter. Next, the script enables the streaming check. When enabled, the API will determine if Skydel stopped streaming unexpectedly and if so, will throw an exception. The check is done automatically once every second when the script starts pushing positions. This check does an API call, which adds a delay that can be unacceptable in some low-latency scenarios; in that case, the streaming check should be disabled.

```
sim.call(EnableMasterPps(True))
```

The EnableMasterPps command enables PPS synchronization.

```
sim.call(ArmPPS())
```

The ArmPPS command performs the hardware initialization. In the case of a Wavefront system, it will also perform the phase calibration. The call is blocking, but it is also possible to post the command and do some other work in parallel and wait later for the ArmPPS function to complete.

```
armPPS = sim.post(ArmPPS())
# do some time consuming work here
sim.wait(armPPS)
```

Any call can be replaced with a post/wait. It is also possible to post several commands and wait after you posted all of them. It is also possible to wait only for the last post sent, but if an error occurred with a previous post, the script might miss an error message and the flow could lead to unexpected behavior.

```
sim.call (WaitAndResetPPS ())
pps0TimestampMs = getLastPPSTimeMs ()
```

The WaitAndResetPPS command returns immediately after the beginning of the next PPS. If the clock on your Linux computer is disciplined with the same PPS source, you can read the clock and round it to the nearest second. This value matches the time of PPS zero.

```
pps0TimestampMs = getClosestPpsTimeMs ()
```

The getClosestPpsTimeMs command is a simple helper function to get the nearest second, but expressed in milliseconds.

If the computer time is not disciplined with the same clock source as the PPS, you can ask Skydel to provide the computer time corresponding to the PPS.

```
pps0TimestampMs = sim.call (GetCom-
puterSystemTimeSinceEpochAtPps0 ()) .milliseconds ()
```

This technique works only if the HIL script is running on the same PC as Skydel (sharing the same computer clock).

```
sim.call (StartPPS (syncDurationMs))
```

The StartPPS returns a few milliseconds before Skydel starts transmitting the RF signal. The RF will start at the precise moment specified in the command with syncDurationMs (relative to PPS zero). So, the script must send the first position immediately after the StartPPS returns and before Skydel starts streaming RF.

```
sim.pushEcefNed(0.0, position, attitude, velocity, angularVelocity)
```

The first push must use zero as the elapsed time. Remember, the elapsed time is relative to the beginning of the RF streaming, and not relative to PPS zero. Also, the elapsed time is expressed in milliseconds and can be fractional (floating number).

After the first push, the script simply loops at the predefined frequency to push new positions.

try:

```
# Send positions in real time for the desired duration
while elapsedMs <= simDurationMs:

    # Wait for the next position's timestamp
    preciseSleepUntilMs (nextTimestampMs)
    nextTimestampMs += timeBetweenPosMs

    # Get the current elapsed time in milliseconds
    elapsedMs = getCurrentTimeMs () - simStartTimestampMs
```

```
# Generate the position
position, velocity = trajectory.generateEcefWithDynamics
(elapsedMs)

# Push the position to Skydel
sim.pushEcefNed(elapsedMs, position, attitude, velocity,
angularVelocity)
```

finally:

```
# Stop the simulation
sim.stop()

# Disconnect from Skydel
sim.disconnect()
```

4.5 Latency

The HIL latency is the delay between the instance of an event on the true trajectory and the realization of this event on the RF signal. Different mechanisms like extrapolation can be implemented to predict these events, but they are only a way to mitigate the effects of latency. That is why it is crucial to minimize the latency of a system as much as possible. Several factors contribute to the latency:

- » The determination (or calculation) of the true trajectory in the HIL Simulator
- » The sampling rate of the true trajectory
- » The time it takes for those samples to reach Skydel
- » The time it takes for Skydel to process and generate a trajectory and create the RF signal corresponding to the trajectory. This factor is referred to as the Engine Latency in the following section.

Skydel supports two strategies to mitigate the effects of latency:

1. The HIL Simulator sends the current receiver position at regular intervals and Skydel can extrapolate the trajectory to eliminate the effects of latency. Skydel will estimate the future position of the receiver based on received samples.
2. The HIL Simulator sends the future receiver position at regular intervals. The position must be received enough time in advance to cover the latency. Skydel will interpolate the trajectory between the samples.

Although Skydel supports both strategies, the script provided in this manual (see ["Code Example" on page 232](#)) only illustrates the first strategy which is simpler to integrate for the client side. The ["Sending Positions in Advance" on page 253](#) section explains how to use the second strategy.

4.5.1 Engine Latency

The Performance subtab is useful for insight on the system's latency, performance, and stability. The right side of the Performance graph is a detailed view on the last second of simulation, while the left side graph is a summary of the last minute of simulation.

During a HIL simulation, the graph shows when the positions were received, relative to the RF time. This is useful to investigate issues with the network or the HIL client.

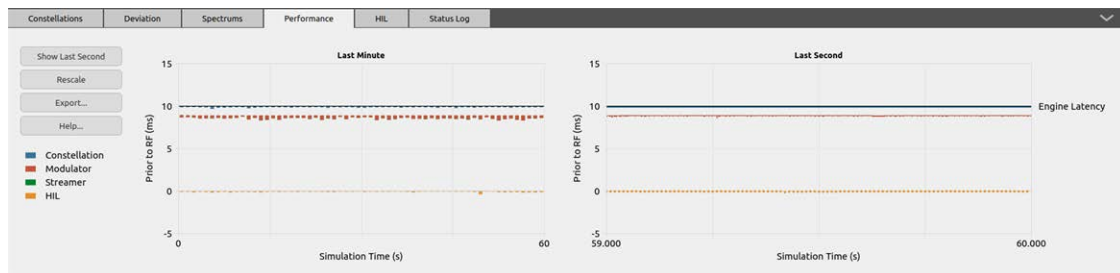

Figure 4-4: Performance Subtab - Showing a minute of HIL simulation

Before reading the next section, it is recommended to review your understanding of the Skydel engine latency fundamentals in the performance section (see ["Main Window Subtabs" on page 19](#)).

4.5.2 HIL Latency

The data flow begins in the constellation worker (see previous section, Engine Latency). It is the entry point where the calculations begin. The constellation worker is computing data ahead of its transmission. Therefore, it is considered that the constellation worker time is in the future (prior to RF output).

The goal of the Skydel HIL engine is to estimate where the receiver will be (constellation time) using real-time data (system time) and minimize estimation errors (oscillation, resonance, jerk, etc.) in the receiver trajectory. The HIL client should not perceive significant discrepancies between its current position and the simulated position at the radio output.

The HIL client is only required to know the current position and optionally the dynamic (velocity, acceleration, and jerk) of the receiver. The HIL client does not transmit the continuous trajectory; instead, it is sampling the receiver position (and dynamic) at regular intervals. We will refer to this information as PVA, or

PVA sample. Each sample is timestamped and corresponds to the time at which the sample was taken.

The HIL client sends PVA samples which are always in the past from the constellation worker point of view (constellation time vs system time). The constellation worker uses the latest PVA sample to extrapolate the receiver position in the future.

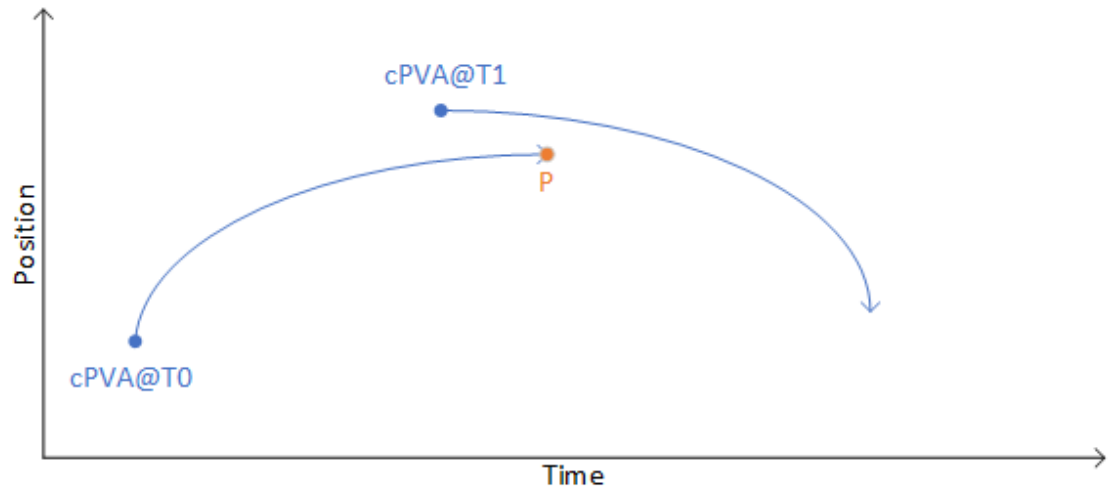

Figure 4-5: Trajectory Extrapolation

When a new sample $cPVA@T1$ is received in the constellation worker, this new sample is already in the past, but not as old as the $cPVA@T0$ sample used to compute the current position P .

The trajectory of the receiver is dynamic and the extrapolation of $cPVA@T0$ will not connect perfectly with $cPVA@T1$. To mitigate the discontinuity, the engine smooths the transition between the 2 extrapolated trajectories. The transition occurs over a period that is limited by the parameter T_{join} . That parameter defines when the actual trajectory catches up or joins the curve extrapolated with the latest PVA sample.

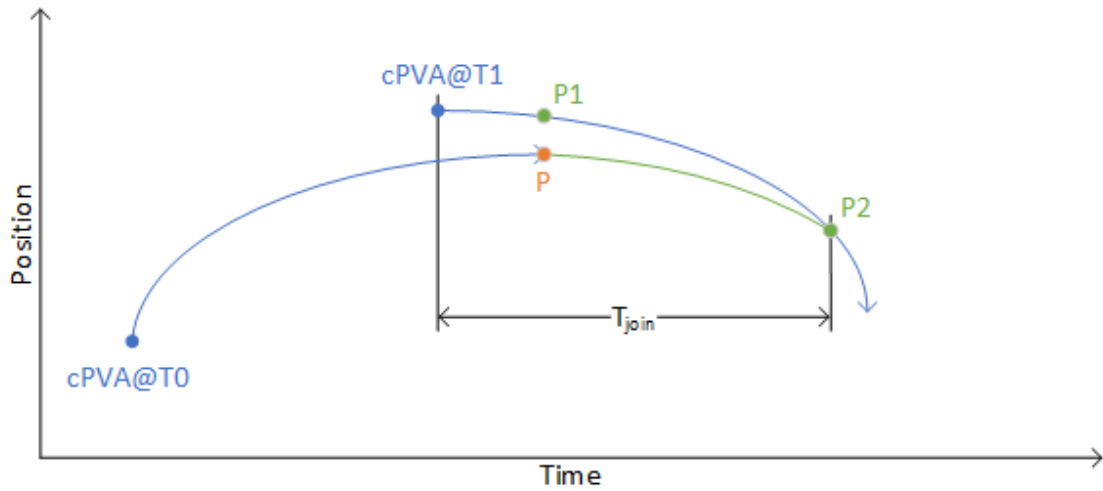

Figure 4-6: Trajectory Discontinuity Mitigation

Before Skydel extrapolates to reach P2, it is expected that HIL client will send a new PVA sample such that a new trajectory converging to this new sample can be calculated and have a smooth transition.

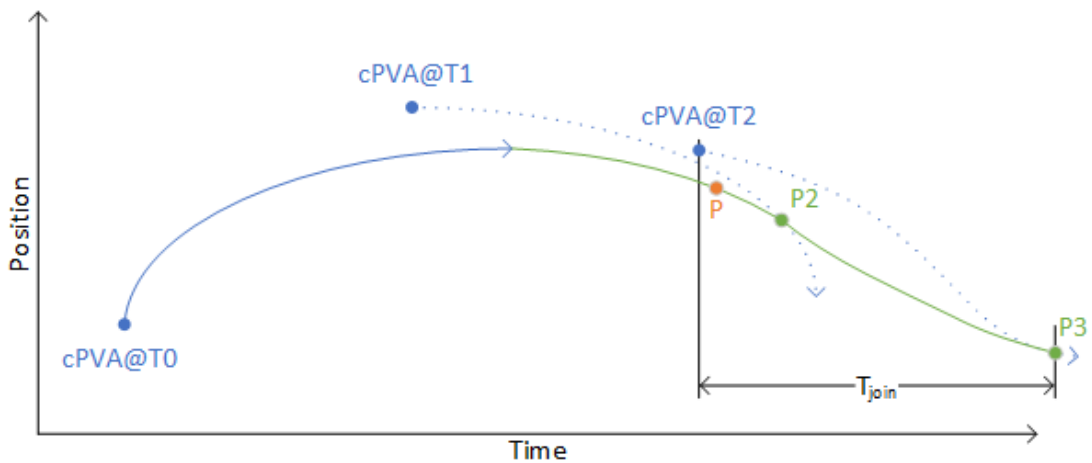

Figure 4-7: Trajectory Smooth Transition

In the event where no PVA sample is received after the constellation thread extrapolation reaches P2, the extrapolation will continue using only cPVA@T1 until the next sample is received. When cPVA@T2 is finally received, a new extrapolation curve is calculated to converge with the latest PVA sample. This may not be an issue in most cases, but this extrapolation is not perfectly deterministic as the new curve is calculated when the PVA sample arrives.

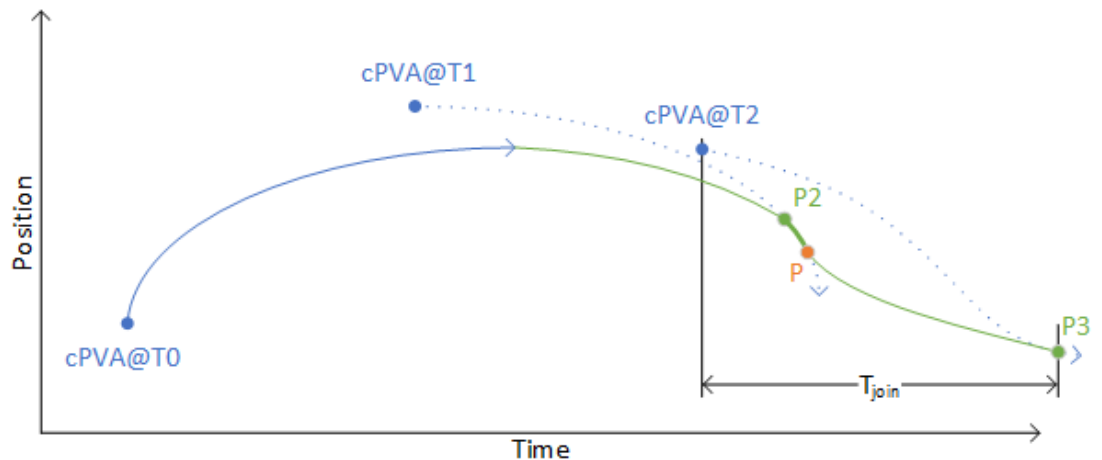

Figure 4-8: Non-Deterministic Trajectory

The T_{join} parameter can be set programmatically. As a rule of thumb, its value should be defined as the sum of the following parameters:

Engine Latency

The maximum time the constellation worker is allowed to simulate ahead of the current system time. This parameter is defined in the Skydel preferences.

HIL Interval

The time between two PVA samples (the inverse of the HIL update rate).

Network Latency

The time it takes for the PVA sample to travel on the network

For example, if you optimize the engine latency to 5 ms, use an HIL update rate of 250 Hz (one sample every 4 ms) and the network latency is within 1 ms, the T_{join} could be set to 10 ms.

4.6 HIL Graph

4.6.1 How it works

Using the HIL feature can create undesired effects such as excessive jerk and error position. These effects are usually caused by simple mistakes which can easily be corrected once identified. The challenge is to make the proper diagnostic in the first place. The HIL graph is a powerful visualization tool that is designed to

make precise diagnoses and give you the confidence the solution is working exactly as you expect.

The HIL graph is in the HIL subtab.

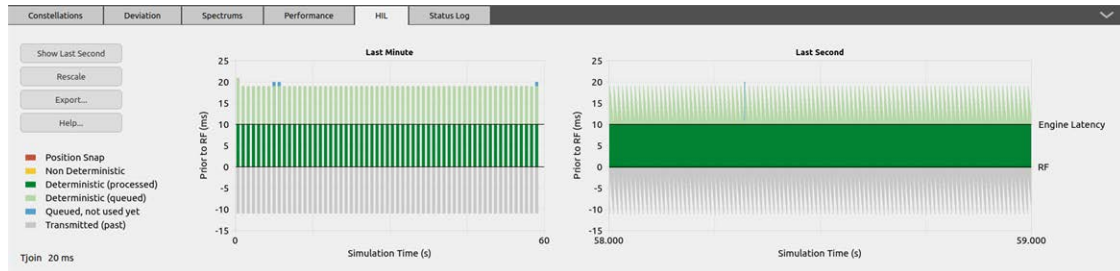

Figure 4-9: HIL Subtab

The graph on the right provides a detailed view of the last second, while the view on the left summarizes the last minute.

If we zoom in on the detailed view on the right, you can see that it is composed of multiple vertical bars.

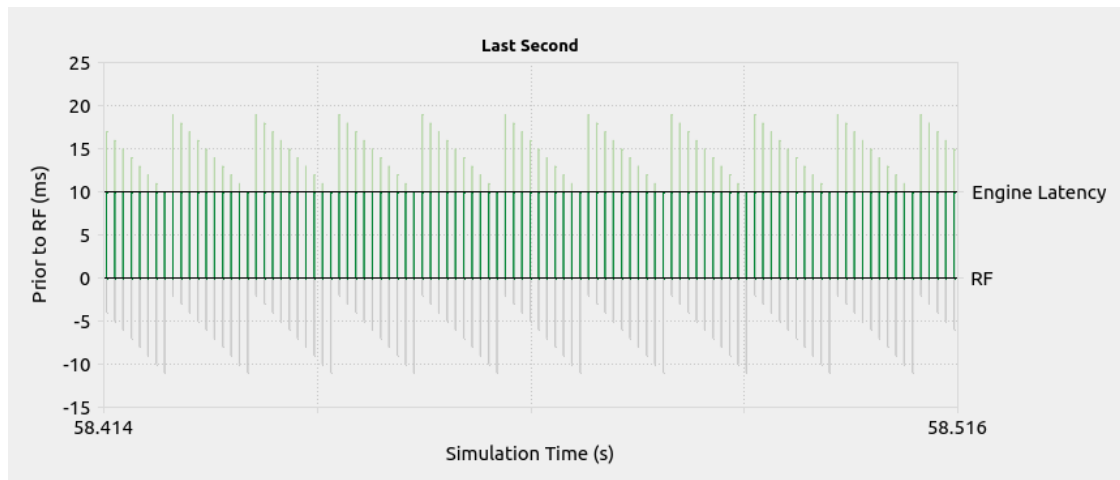
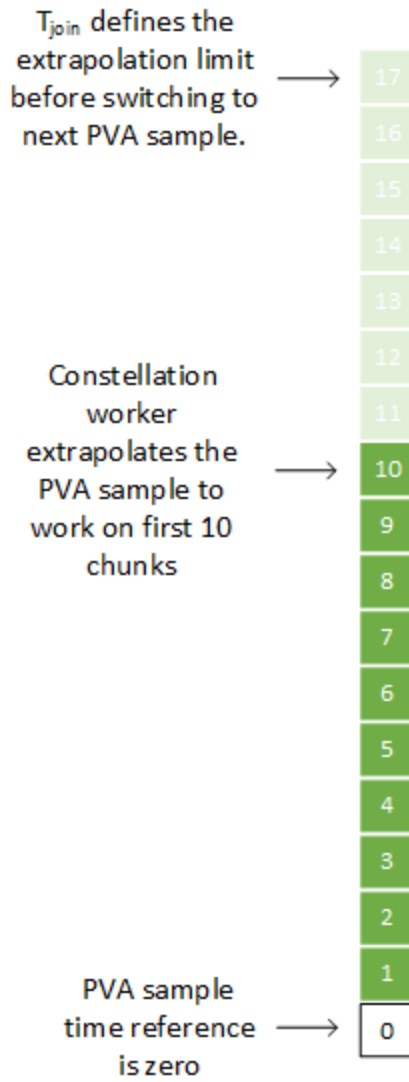
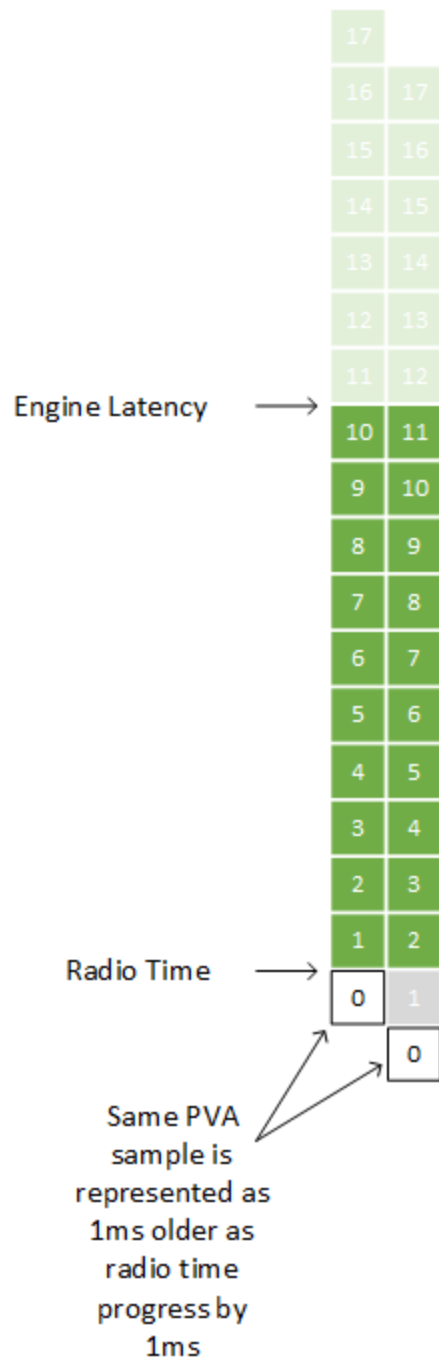

Figure 4-10: HIL Graph Zoom

Each vertical bar represents a PVA sample. The vertical axis is time. The bottom of the vertical bar corresponds to the PVA time reference, and the height of the bar is defined by the value of T_{join} . The zero on the vertical axis is the current system time. Because the PVA sample time reference is in the past, the bottom of the vertical line can be negative. A value of -5 means the sample was taken 5 milliseconds ago. Because Skydel uses a pipeline to compute chunks in advance, the constellation worker can be several milliseconds ahead of the system time. With an engine latency of 10ms and a T_{join} value of 17 ms, the first PVA sample bar can be illustrated like this:



The horizontal axis represents the system time as well. As the system time advance by chunk of 1 millisecond, the PVA sample gets older by 1 ms. A 1 ms step on the HIL graph can be illustrated like this:



When the system time progress by 1 ms, the constellation worker is allowed to work on the next chunk (#11).

As defined by T_{join} , the constellation worker will extrapolate the PVA sample up to chunk #17. The constellation worker expects a new PVA sample before it starts working on chunk #18. That new PVA sample could have a time reference of 5 ms.

With a Tjoin value of 17 ms, that new sample can be extrapolated up to chunk #22.

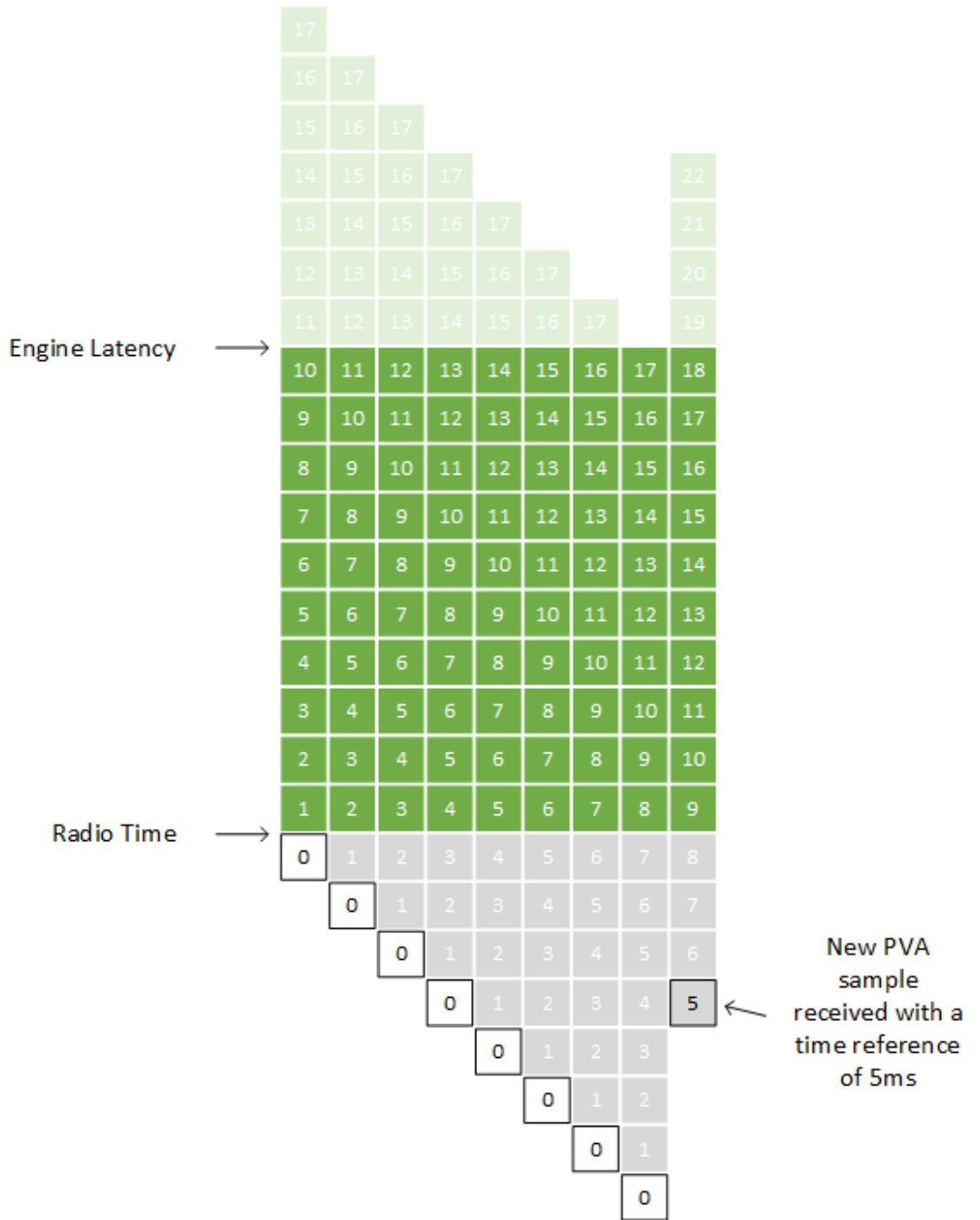

As more PVA samples are added to the graph, it creates a characteristic saw tooth geometry with peaks and valleys. An optimal HIL integration will have reg-

ular peaks (same height, same interval). The valleys will be as close as possible (from top and bottom) to the dark green area.

A PVA sample doesn't always arrive at the exact moment it is needed. If it arrives a couple of milliseconds earlier, it will appear in the HIL graph in blue. It means the sample is already received but queued to be used later.

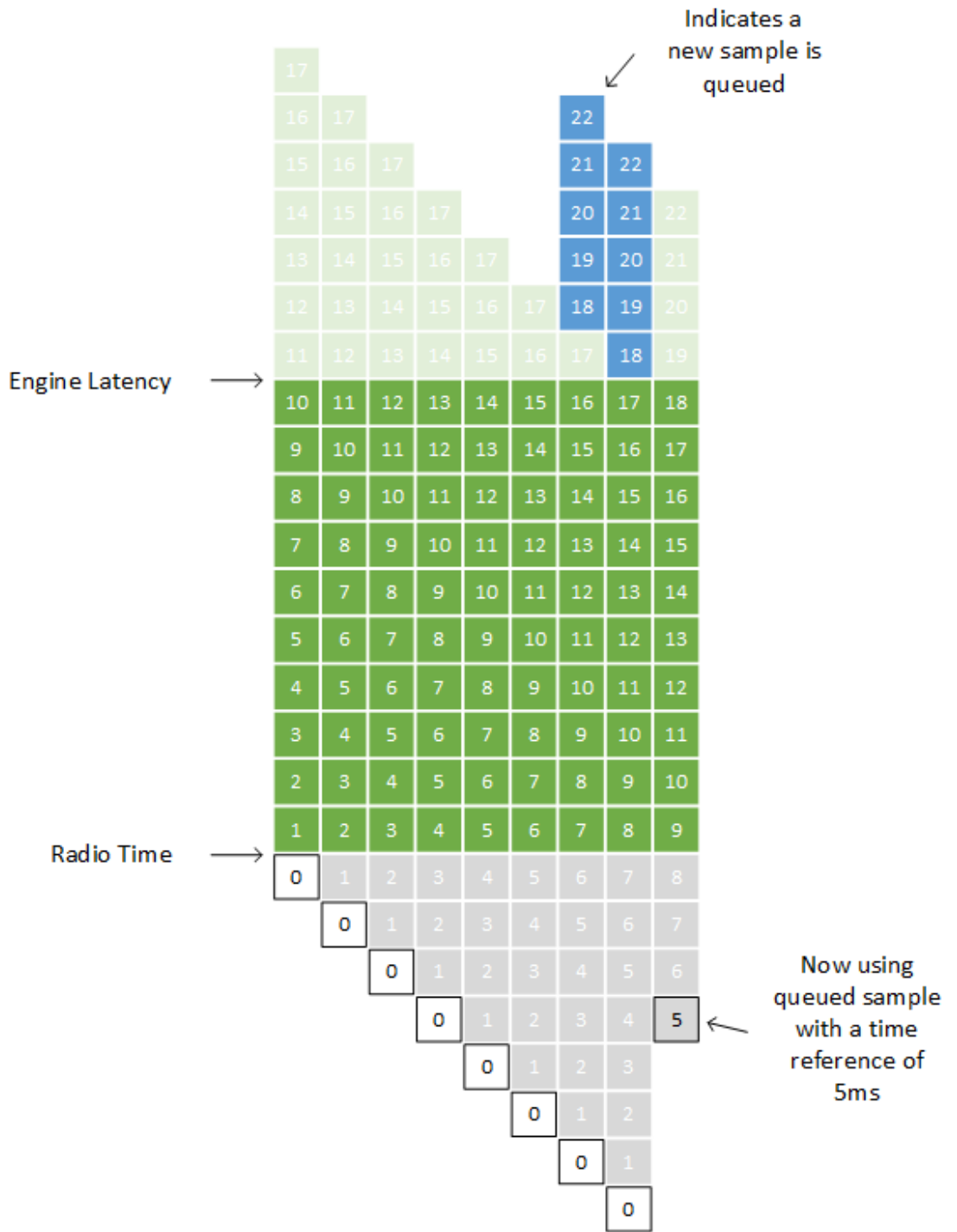

When a PVA sample does not arrive when the constellation worker needs it, the worker will extrapolate beyond the limit defined by T_{join} . In this case, the chunk will be shown in yellow.

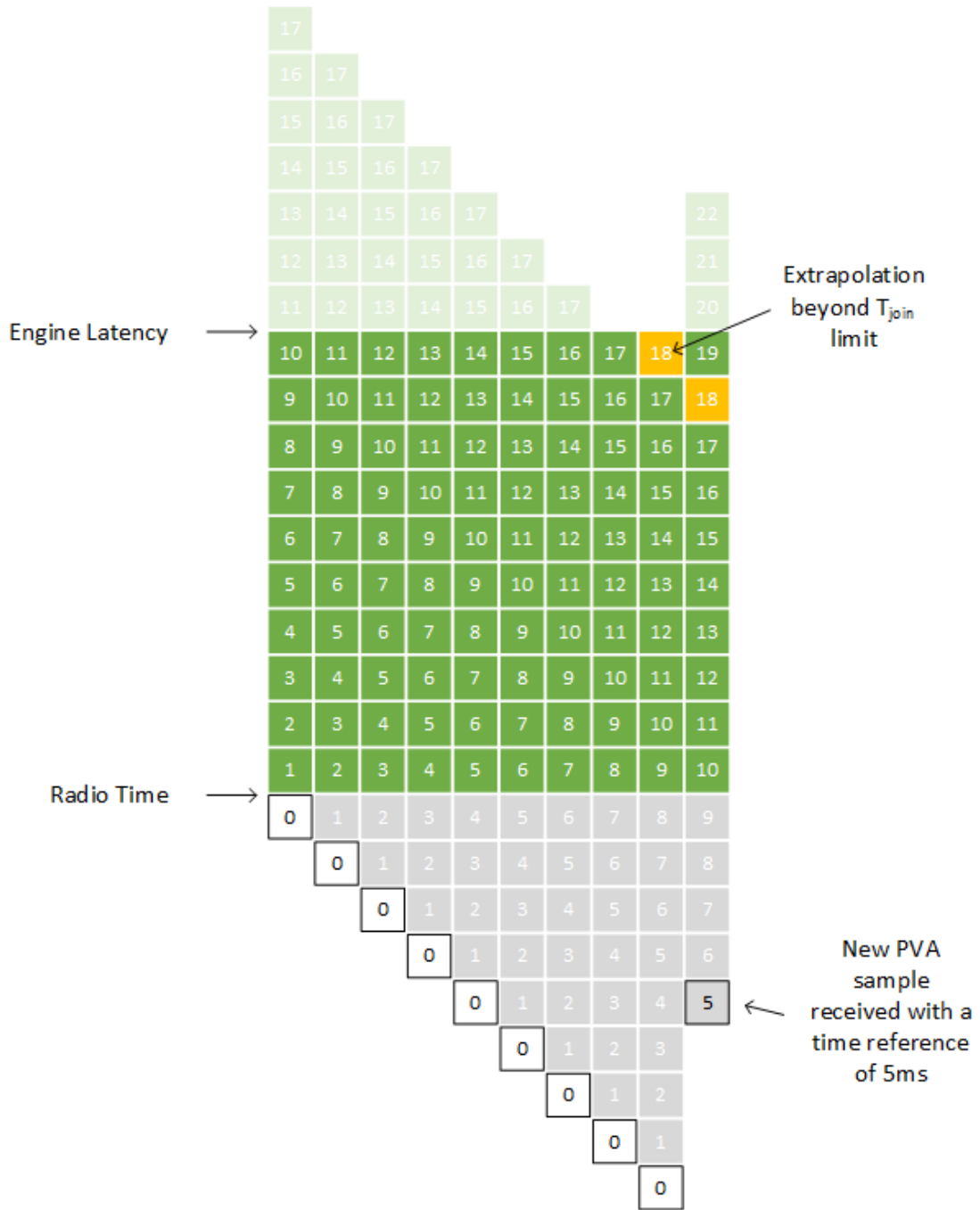

4.6.2 Common Patterns (Extrapolation)

As explained in the previous section, when the settings are optimal, the HIL graph has regular peaks and valleys. Depending on the settings and the HIL integration, you may observe different patterns. In this section we explain typical deviations

to the optimal pattern, the reasons behind them, and the possible solutions to improve the performance.

Note that if you use a T_{join} value of zero, refer to "Sending Positions in Advance" on page 253 section and the resulting "Common Patterns (Extrapolation)" on the previous page.

4.6.2.1 Optimal

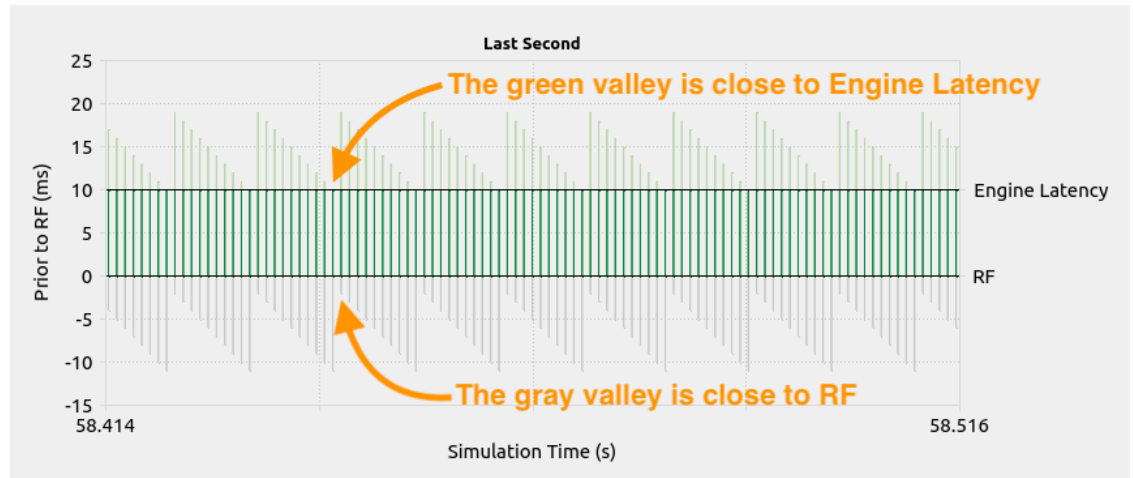

Figure 4-11: Optimal Pattern

Observations:

- » The green valleys reach the Engine Latency and stay green; there is no blue, yellow or red. It means that HIL trajectory samples are received just in time, not too soon, not too late.
- » The gray valleys are close to the RF. It means the T_{join} value and the HIL trajectory sampling rate are well configured.
- » All peaks and valleys are very similar. It means the samples are received at fixed interval with little jitter.

4.6.2.2 T_{join} Value Too Large

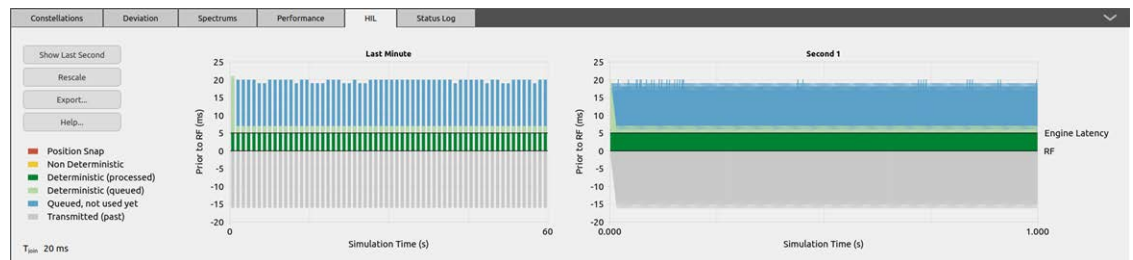

Figure 4-12: Large T_{join} Value

Observations:

- » Excessive blue color in the graph means that HIL trajectory samples are queued and not used until later. At the same time, there is excessive gray color at the bottom which indicates the samples are used for a prolonged period. This is caused by a large T_{join} value.
- » Reducing T_{join} will make Skydel move to the next HIL trajectory sample sooner. You can reduce the T_{join} value until you start seeing yellow or red and then back off a little. If being perfectly deterministic in the extrapolated trajectory is more important, you prefer blue to yellow. If shorter latency is more important in your system, you can tolerate more yellow and less blue.

The following image focuses on the last second to show more details.

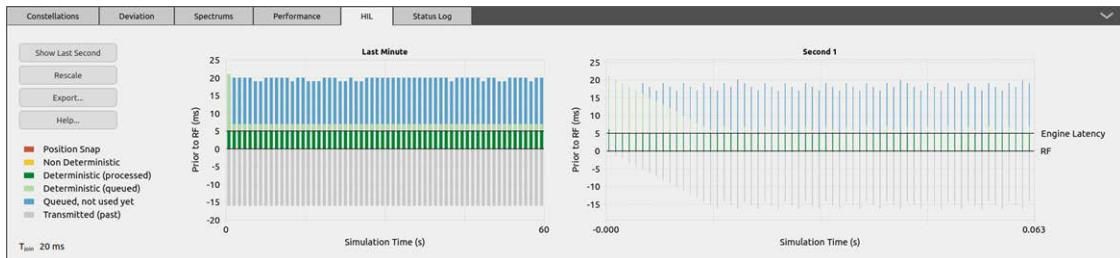

Figure 4-13: Large T_{join} Value (Zoom)

T_{join} Value Too Small

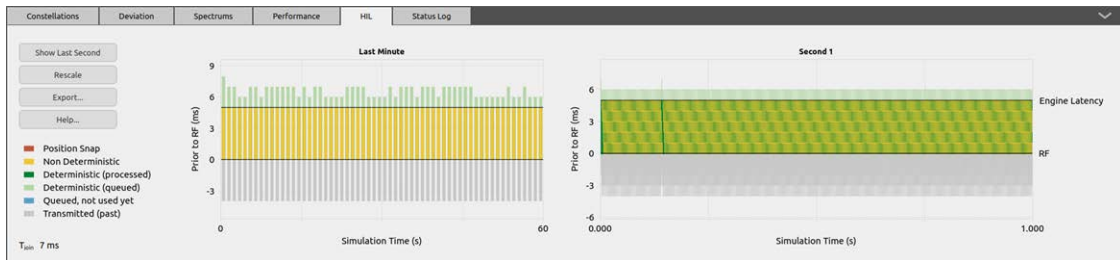

Figure 4-14: Small T_{join} Value

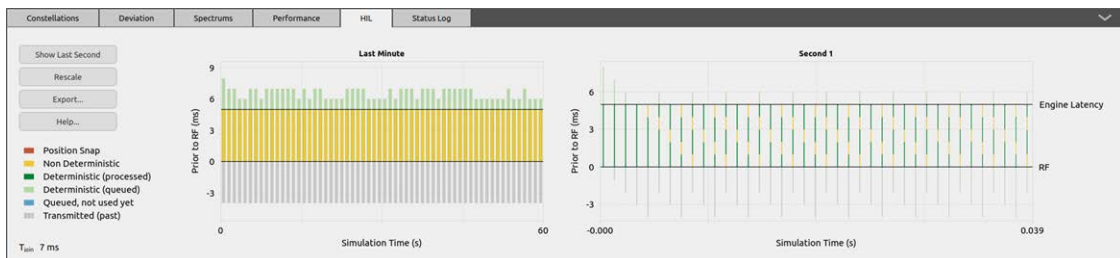

Figure 4-15: Small T_{join} Value (Zoom)

Observations:

- » Excessive yellow (or red) color in the graph means that T_{join} is too small. You can either increase T_{join} which also increases the system latency, or increase the sampling rate of the HIL trajectory, or reduce the engine latency. You can use the performance graph (see "Performance" on page 20) to determine if you can reduce the engine latency without risking underrun errors.
- » Another possible explanation is that you have a bias between the HIL simulator clock and the Skydel simulator clock. You can observe the timestamp offset with the Skydel clock in the performance subtab (see "Performance" on page 20). The HIL dots (orange) should be very stable and near the 0.

4.6.2.3 Jitter

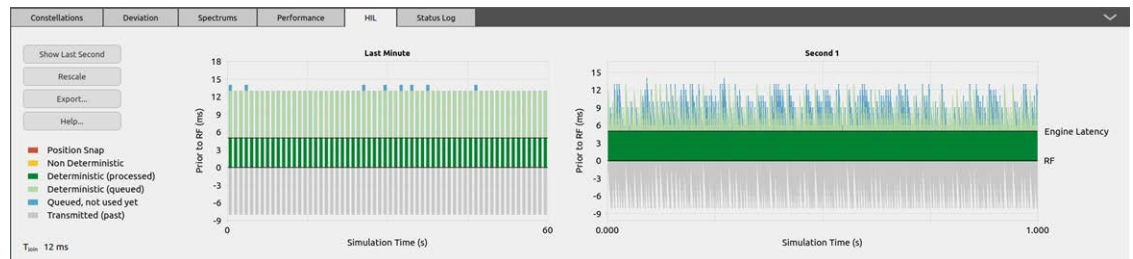

Figure 4-16: Jitter

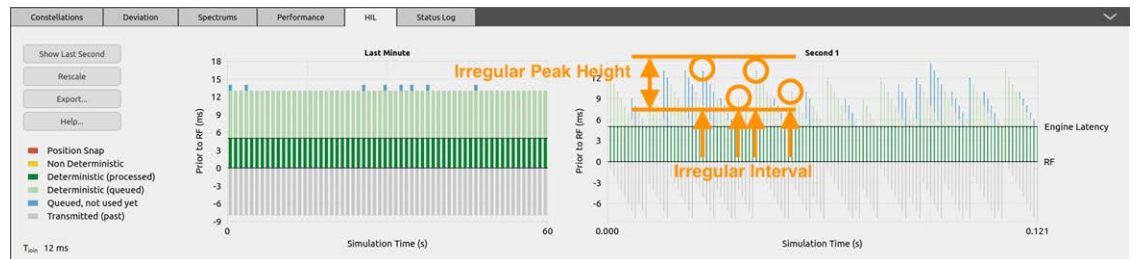

Figure 4-17: Jitter (Zoom)

Observations:

- » The peaks are not at regular heights.
- » The peaks are not at regular intervals.

There are multiple possible reasons that can explain this pattern:

- » Irregular intervals are caused by the varying HIL trajectory samples rate of arrival. The HIL simulator could be sampling at an irregular interval, or the

network could be congested.

- » Irregular height can be caused by poor precision or poor accuracy on the timestamps. This can be caused by unreliable timing functions or clock source on the HIL simulator. Or it can be the network interface that is not sending packets immediately.
- » When both heights and intervals are irregular, it can mean that multiple source of errors are present simultaneously.

Although everything is green or blue (no yellow, no red), this jitter might cause problems, especially if the timestamps are inaccurate. It is recommended to analyze the resulting receiver trajectory log (see "[Logging](#)" on page 85) for discontinuities or anomalies. Computing the first or second derivatives might also reveal insufficient precision in the HIL trajectory samples provided to Skydel.

The timestamp offset relative to the radio time of each HIL trajectory sample is also displayed in the performance subtab (see "[Performance](#)" on page 20) as shown in the image below.

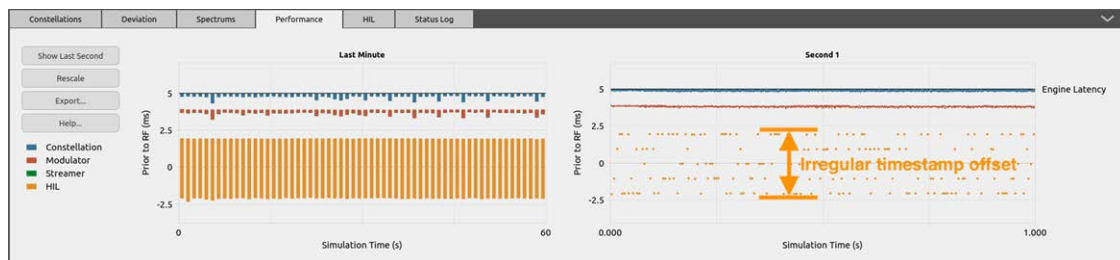

Figure 4-18: Jitter Visible on the Performance Graph

Lost Sample

HIL is a time-sensitive application and for that reason Skydel uses the User Datagram Protocol (UDP) to transmit the trajectory samples. UDP does not recover lost packets. A lost packet can be visible in the HIL graph when the Tjoin value is not too large.

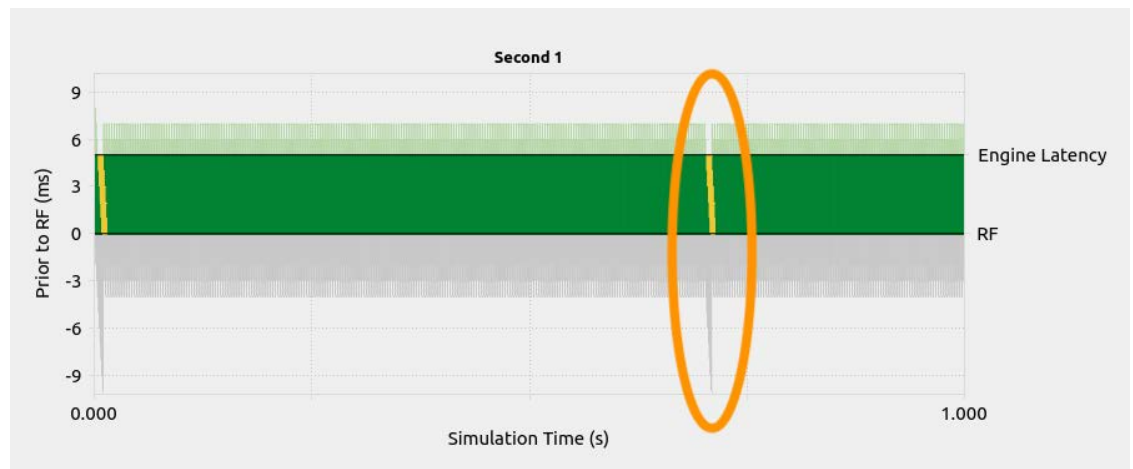

Figure 4-19: Lost Sample

If you zoom in, you can see a packet seems to be missing because the interval between the samples is stable except for 1 gap which resulted in non-deterministic extrapolation (yellow) of an older trajectory sample.

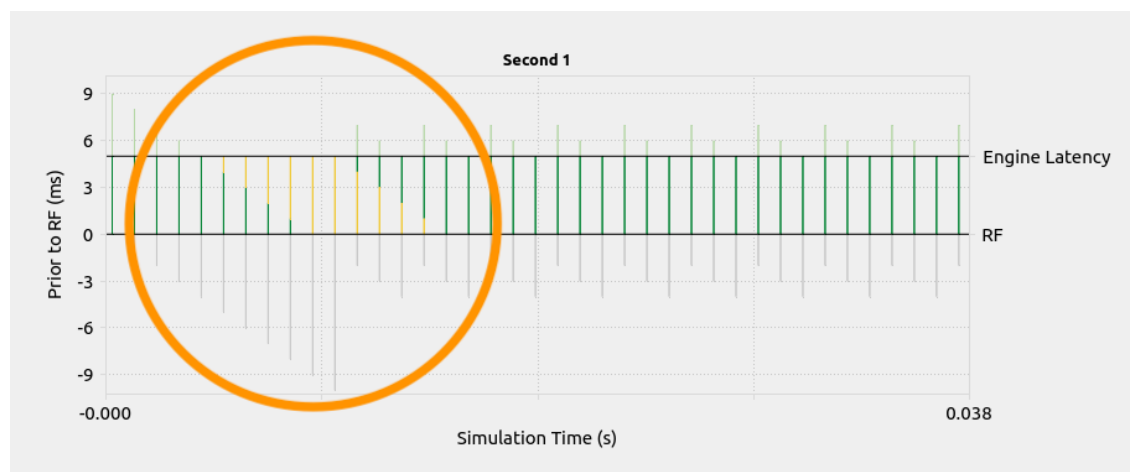

Figure 4-20: Lost Sample (Zoom)

4.6.2.4 Late Sample

Skydel will extrapolate a sample until the moment when the constellation worker reaches the time defined by the sample reference time plus the Tjoin time. At that moment, the worker will use the next queued sample; if there are no queued samples, Skydel has no other choice than to extrapolate the sample beyond the limit defined by Tjoin. This situation is illustrated in yellow in the HIL graph. If this situation lasts long enough and the next sample arrives when its reference time plus Tjoin is already in the past, Skydel will not try to smooth the transition and it

will snap the trajectory on the newly received sample. This condition is shown in red.

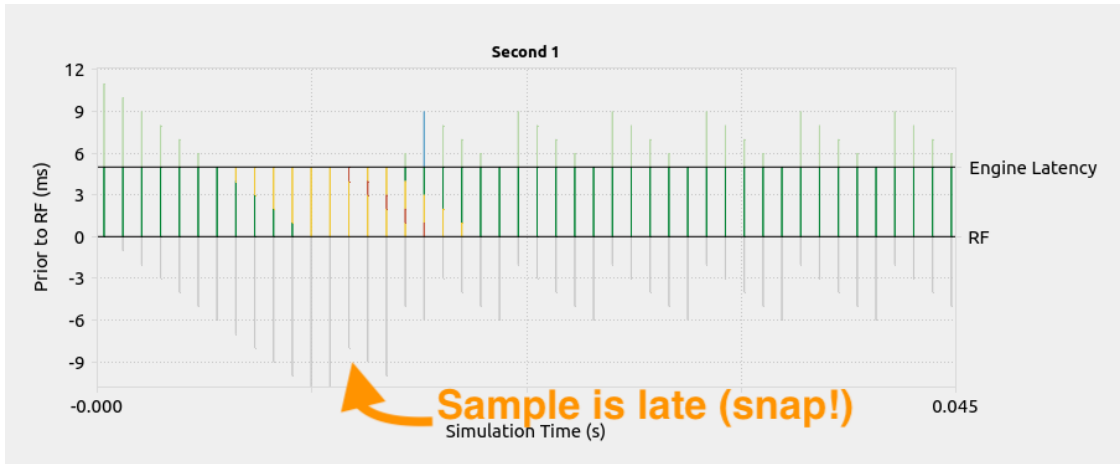

Figure 4-21: Late Sample (Snap!)

4.6.2.5 Falling Behind / Catching Up

When the constellation worker is falling behind, you can see the effect in the performance graph (see "Performance" on page 20) as well as in the HIL graph as shown in the image below.

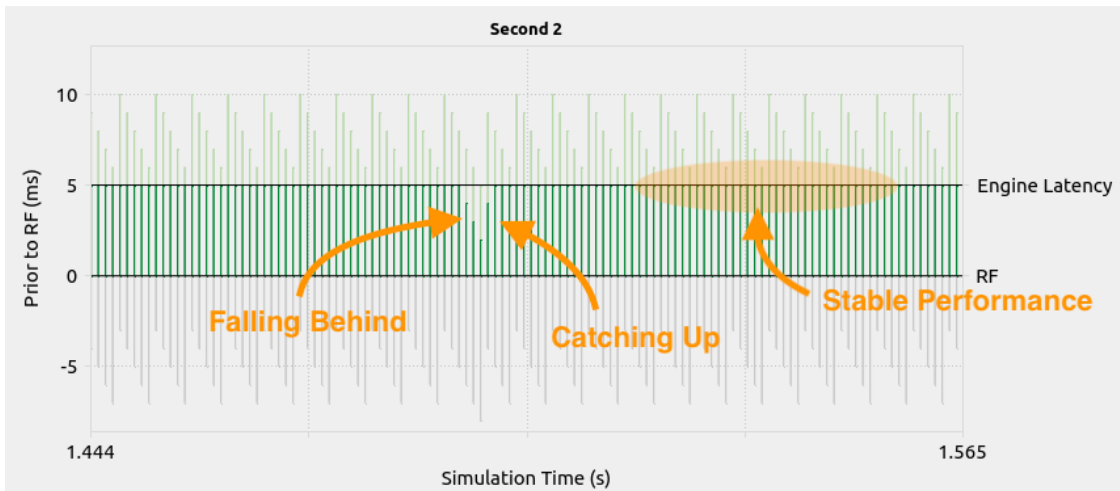

Figure 4-22: Falling Behind / Catching Up

4.7 Sending Positions in Advance

In previous sections, we explain how the HIL simulator sends the current receiver position in real-time and at regular intervals. In that case, Skydel uses the provided samples to extrapolate the trajectory and compensate the effect of the latency. It is possible to use Skydel in a different way, where the client side (the HIL simulator) extrapolates the trajectory to provide position samples in advance (timestamp in the future) so that Skydel will interpolate the trajectory between the current position and the future position. This section explains how this can be done and the visible effects on the HIL graph common patterns.

The Skydel engine latency (see "[Performance](#)" on page 44) has a direct effect on the amount of time the HIL simulator has to send the samples in advance.

In the previous "[Code Example](#)" on page 232, the Python script plays the role of the HIL simulator and it sends the current position at regular intervals. To operate in interpolation mode instead of extrapolation, the HIL simulator must send the position for a time in the future instead of the current position. The time offset should be the sum of:

- » Engine Latency
- » HIL sampling interval
- » Estimated network latency

For example, with an engine latency of 10 ms, a HIL sampling rate of 200 Hz and a network latency of 1 ms, the offset should be 16 ms.

Sending the initial position with a timestamp of 0 ms, as shown in the "[Code Example](#)" on page 232, is still required, but when the simulation starts, instead of sending the current position, the HIL simulator must send the position for a time in the future. To do so, it must take the current elapsed time (relative to the moment when the simulation started) and add the time offset (16 ms in the example above) and extrapolate the position for that time.

The table below shows the samples sent to Skydel for the following example:

- » Engine Latency = 10 ms
- » HIL Sampling Rate = 200 Hz (one sample every 5 ms)
- » Network Latency = 1 ms

Scenario time when the sample is transmitted to Skydel	Timestamp of the sample
Before the simulation starts	0 ms
-0 ms	16 ms

Scenario time when the sample is transmitted to Skydel	Timestamp of the sample
-5 ms	21 ms
-10 ms	26 ms
-15 ms	31 ms



Note: To reduce the system latency, it is not sufficient to simply increase the HIL sampling rate. It is also important to reduce the engine latency and the network latency.



Caution: The Scenario time is relative to the real-time at the radio RF output. Be careful with the elapsed time notion: it can refer to the Constellation Worker time which is ahead of the Scenario time by as much as the value defined by Engine Latency.

4.7.1 Common Patterns (Interpolation)

The common pattern for interpolation will differ from the patterns observed for extrapolation (see "[Common Patterns \(Extrapolation\)](#)" on page 246) when T_{join} is greater than zero.

4.7.1.1 Optimal

Using the previous example:

- » Engine Latency = 10 ms
- » HIL Sampling Rate = 200 Hz (one sample every 5 ms)
- » Network Latency = < 1 ms
- » Resulting Time Offset = 16 ms

The HIL simulator sends the samples with a timestamp 16 ms in the future. You can observe the following optimal pattern:

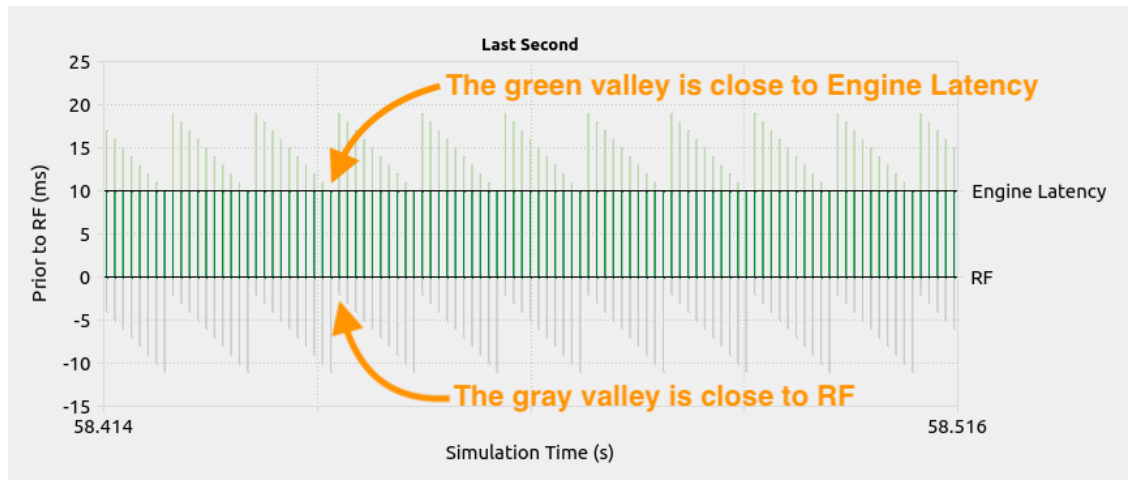

Figure 4-23: Optimal Pattern

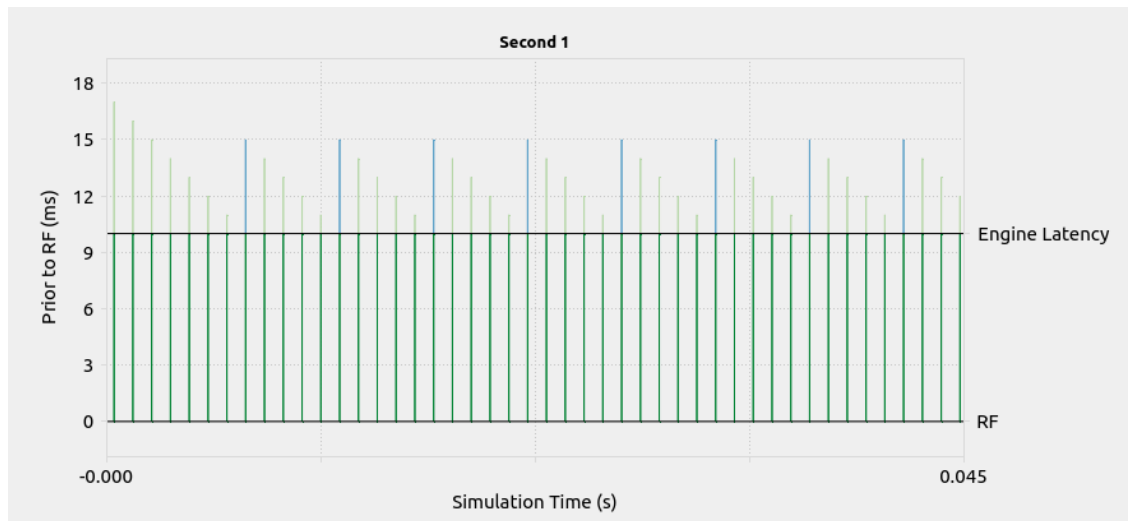

Figure 4-24: Optimal Pattern (Zoom)

Observations:

- » There is no gray color at the bottom. Because T_{join} is set to zero, Skydel will not use a sample with a timestamp in the past as long as there are available queued samples.
- » There is minimal blue color at the top. That means the samples arrive just when they are needed, and not before.

4.7.1.2 Time Offset Too Large

When the time offset is too large, the HIL simulator extrapolates too far in the future. Using the same conditions found in the optimal example above, but with a time offset of 25 ms instead of 16 ms, you can observe the following pattern:

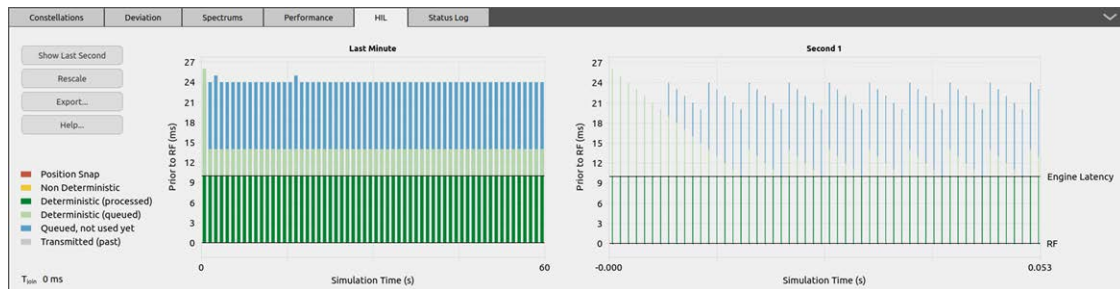

Figure 4-25: Large Time Offset Pattern

Observations:

- » There is no gray color at the bottom. Because T_{join} is set to zero, Skydel will not use a sample with timestamp in the past as long as there are available queued samples.
- » There is excessive blue color at the top. That means the time offset for extrapolation on the HIL Simulator could be smaller.
- » If the HIL Simulator reduces the sampling rate, the samples will be used for a longer duration and there will be less queuing of samples (less blue). It is usually preferable to reduce the time offset and keep the sampling rate high. Note that a sampling rate higher than 1 kHz is useless because Skydel will take a maximum of sample per millisecond and ignore the other samples.

4.7.1.3 Time Offset Too Small (or Sampling Rate Too Low)

When the time offset is too small, the HIL simulator does not extrapolate far enough in the future. Using the same conditions found in the optimal example above, but with a time offset of only 13 ms instead of 16 ms, you can observe the following pattern:

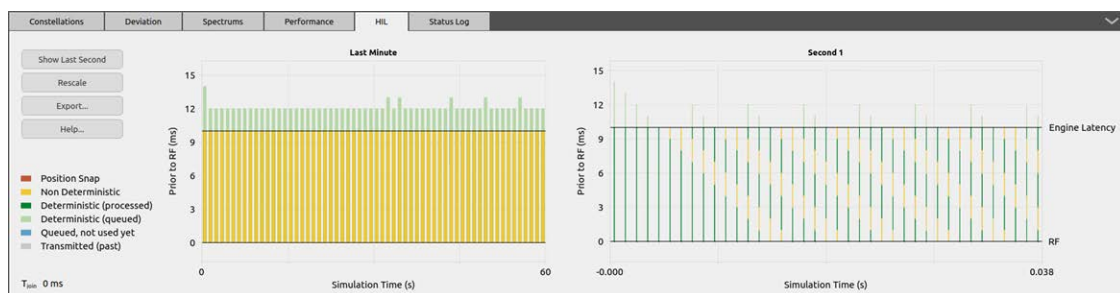

Figure 4-26: Small Time Offset Pattern

Observations:

- » There is no gray color at the bottom. Because T_{join} is set to zero, Skydel will not use a sample with a timestamp in the past as long as there are available queued samples.
- » When the constellation worker time, which is ahead of the scenario time, reaches the last queued time stamp, it can no longer interpolate with the next point, so it continues by extrapolating the trajectory as shown in yellow in the graph. To solve this issue, the HIL simulator should either increase the time offset, the sampling rate, or both.

4.7.1.4 Jitter

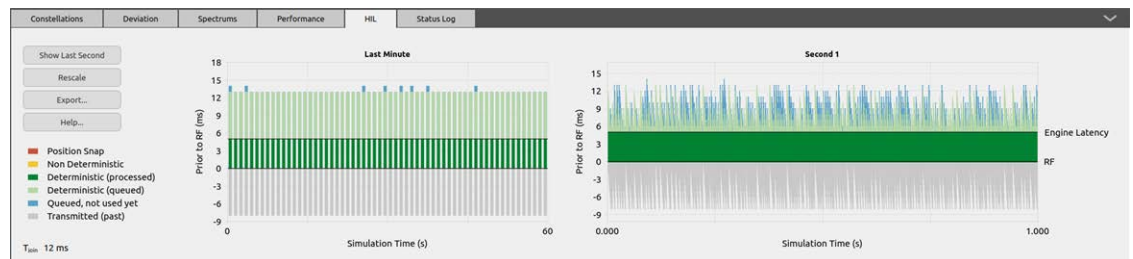

Figure 4-27: Jitter

Observations:

- » The peaks are not at regular heights.
- » The peaks are not at regular intervals.

There are multiple possible reasons that can explain this pattern. Refer to the ["Jitter" on page 249](#) section for explanations.

4.7.1.5 Lost Sample



Figure 4-28: Lost Sample

Observation:

- » The peaks are at regular intervals, except for one gap which is not compensated by closer peaks following the gap.
- » For additional information on lost samples, read this section here.

CHAPTER 5

Timing

This chapter explains timing and synchronization concepts found within the Skydel application, and how that timing relates to advanced functionality.

The following topics are included in this Chapter:

5.1 Introduction to Timing	260
5.2 Single Skydel Setup	262
5.3 Main/Worker Setup	265
5.4 Timing Receiver Setup	268
5.5 Trigger (USRP X300 AUX I/O)	269

5.1 Introduction to Timing

While Skydel can be used with little knowledge of its internal working model, some simulation use cases will benefit from a deeper understanding of its operating principles. For example, if you want to:

- » synchronize RF with external PPS;
- » synchronize multiple simulators;
- » synchronize time with the live sky;
- » control a receiver's trajectory in real-time (Hardware-in-the-loop);
- » or any combination of the above use cases.

The Skydel simulation engine can be controlled by the user interface (GUI) or a client API. To simplify the documentation, the diagrams in the following sections will refer to the API client setup as pictured below.

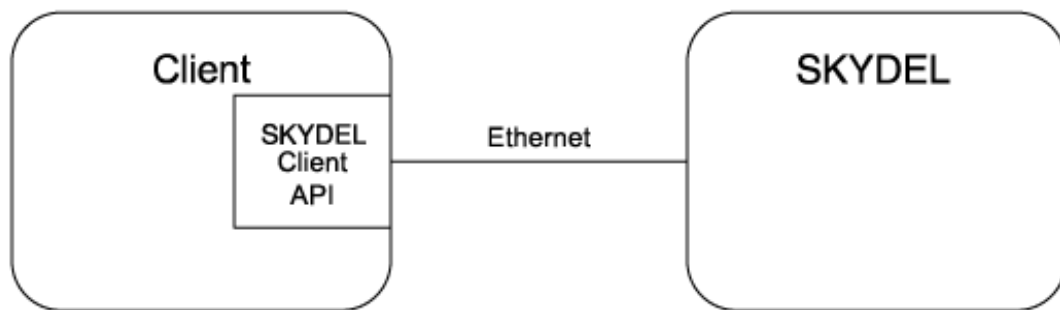

Figure 5-1: Skydel and Skydel Client

When synchronizing multiple instances of Skydel, we use a Main/Worker terminology. The client usually connects only to the Skydel Main, and the Skydel Main connects to the Worker(s). In some circumstances, the client may want to connect to the Worker as well.

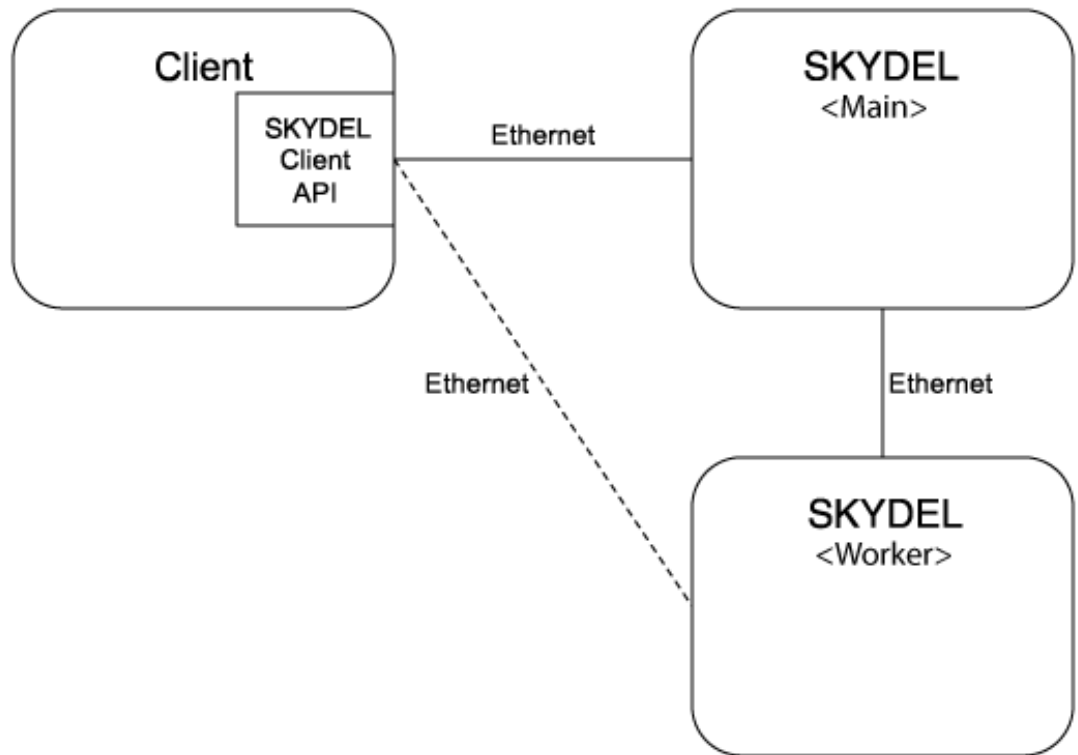

Figure 5-2: Main/Worker and Skydel Client

To better understand the timing diagrams in the following sections, it can be helpful to refer to the following Skydel state machine diagram.

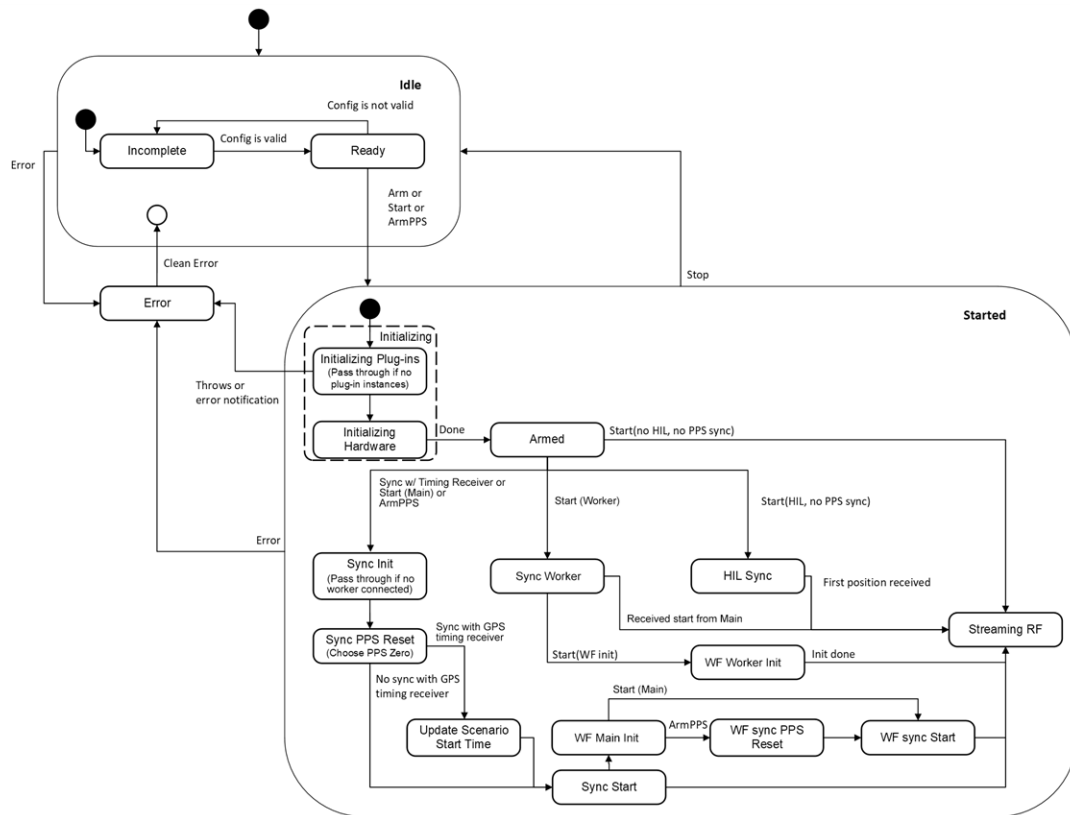

Figure 5-3: Skydel state machine

5.2 Single Skydel Setup

This section describes use cases using hardware setups based on Ettus USRP X300 radios (and an OctoClock-G clock distribution module when appropriate).

5.2.1 Normal Start

Normal Start refers to a scenario where Skydel:

- » does not synchronize with other simulators (see "[Synchronize Simulators](#)" on page 100);
- » does not synchronize the simulation's start time with a timing receiver (see "[GPS Timing Receiver Time](#)" on page 77);
- » does not synchronize (see "[Synchronize Simulators](#)" on page 100) with an external PPS source (by setting Skydel as main instance).

The sequence starts when the client API sends the Start command, or when the user clicks the Start button in the Skydel GUI.

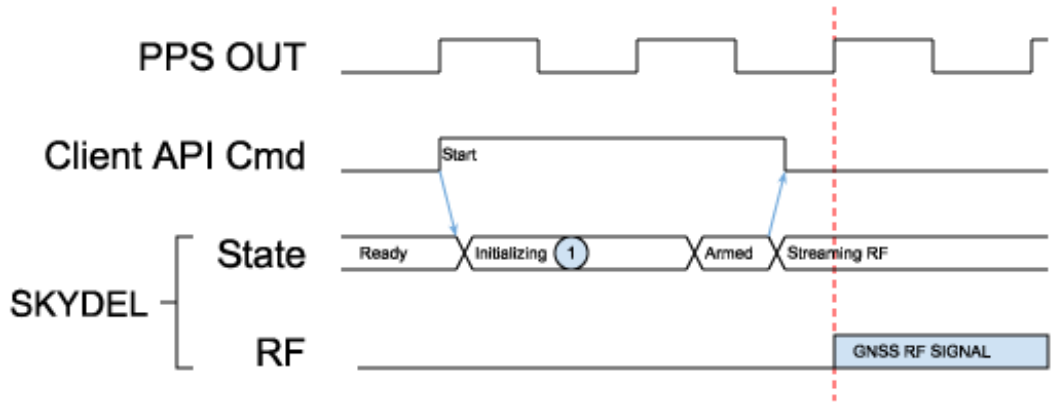

① The time required to complete the hardware initialization may be longer. The duration was compressed here to make the diagram easier to read.

Figure 5-4: Normal start

In this use case, Skydel ignores the external PPS. Instead, it uses its own internal PPS source. The PPS OUT connector on the radio is aligned with the internal PPS. The duration of the start command can change for each run, but the RF signal will always be aligned with a PPS rising edge.

The Start command is blocking until Skydel enters the Streaming RF state.

 **Note:** When Skydel enters the Streaming RF state, it doesn't mean that it is transmitting RF at the exact same moment. The GNSS RF signal transmission only starts at the next PPS rising edge.

5.2.2 Arm & Start

This use case is similar to ["Normal Start" on the previous page](#) except that the client API arms the system before starting it. The Arm command returns when the hardware is initialized and ready to start. Once the initialization is completed, the Start command is executed with minimal delay.

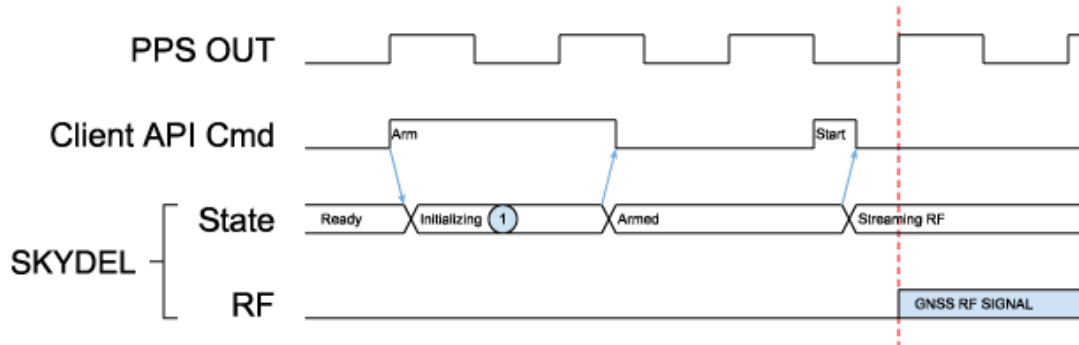

① The time required to complete the hardware initialization may be longer. The duration was compressed here to make the diagram easier to read.

Figure 5-5: Arm & Start

Note: Even if you were to arm the system before starting it, Skydel would wait for the next PPS rising edge. This means that even if the command returns after only a few milliseconds, the GNSS RF signal streaming may start up to 1 second later.

5.2.3 HIL Start

This use case is similar to "Normal Start" on page 262 except that the vehicle trajectory type is HIL. In this scenario, the client transmits the vehicle's trajectory in real-time.

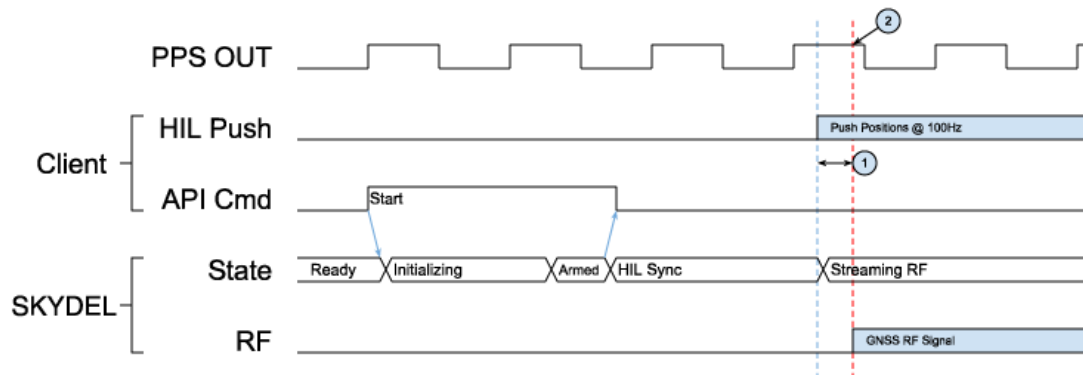

① The first vehicle position pushed (HIL Push) by the client becomes the trigger that starts the streaming 200 ms later. This delay is defined by the Streaming Buffer duration and can be changed in the Preferences general tab.

② The sequence is not aligned with the PPS signal.

Figure 5-6: Start HIL



Note: In this use case, the GNSS RF Signal and the PPS OUT are not synchronized. This is because the simulator starts as soon as it receives the first HIL position. To synchronize the GNSS RF Signal with a PPS while using HIL trajectory, refer to section "[Main/Worker Sync With PPS](#)" on the next page.

5.2.4 Sync With External PPS

To synchronize Skydel with an external PPS source, refer to section "[Main/Worker Setup](#)" below. The difference with Main/Worker scenario described in the other section is that this use case only has a Main - there are no Workers. Make sure the setup (see "[Main/Worker Setup](#)" below) is properly configured to use external 10 MHz and PPS sources and make sure the Main checkbox is set (see "[Synchronize Simulators](#)" on page 100).

5.3 Main/Worker Setup

This section describes use cases with hardware setups based on Ettus USRP X300 radios and an OctoClock-G. In all use cases, the Sync Time (Main) checkbox (see "[Synchronize Simulators](#)" on page 100) must be checked for the Main and the Sync Time (Worker) checkbox must be checked for the Worker(s).

When checking a Sync Time checkbox (either for the Main or the Worker), the Ettus X300 radio must use the external PPS signal source from the OctoClock-G; it should be connected to the PPS TRIG IN connector on the back of the X300.



Caution: When the USRP X300 radio is configured to use an external 10 MHz and PPS sources, the USRP PPS OUT is disabled and can not be used.

5.3.1 Main/Worker Normal Start

This use case describes how to synchronize multiple simulators to commence on the same PPS rising edge. The main Skydel instance will automatically select which PPS to use. To manually select the PPS, refer to section "[Main/Worker Sync With PPS](#)" on the next page.

In the following timing diagram, the sequence is initiated by the client API when it sends the Start command to the main Skydel instance. This command is blocking until the Main enters the Streaming RF state.

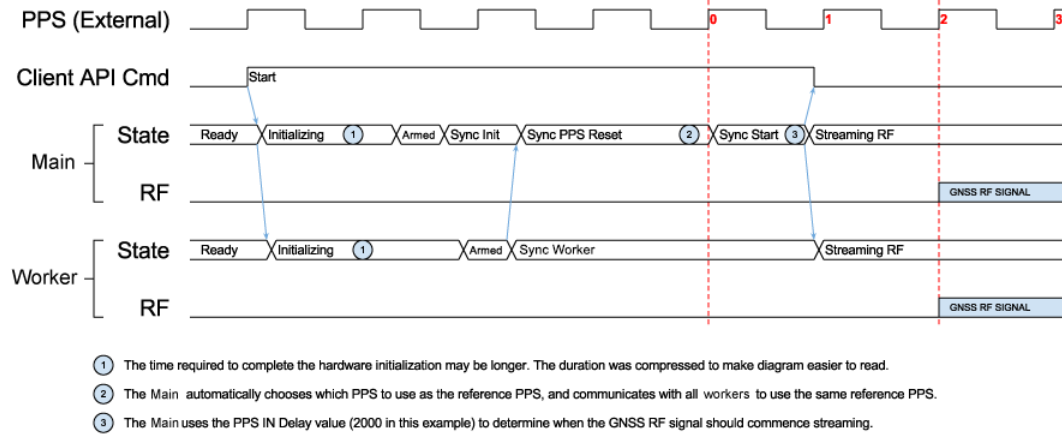

Figure 5-7: Main/Worker sync with PPS rising edge

When the Main instance receives the Start command, it begins a process to initialize itself, as well as each of the Workers. Once this initialization is completed, the Main monitors the PPS and selects one as the reference PPS. The Main also guarantees that all Workers are using the same reference PPS. Once the reference PPS has been determined, the Main uses the " PPS IN Delay" on page 37 value to program the GNSS RF signal start.

5.3.2 Main/Worker Sync With PPS

You can synchronize multiple simulators (one Main with one or more Workers) with a specific PPS rising edge.

In the following timing diagram, the sequence is initiated by the client API when it sends the ArmPPS command to the Main Skydel instance. This command is blocking until the main enters the Sync PPS Reset state.

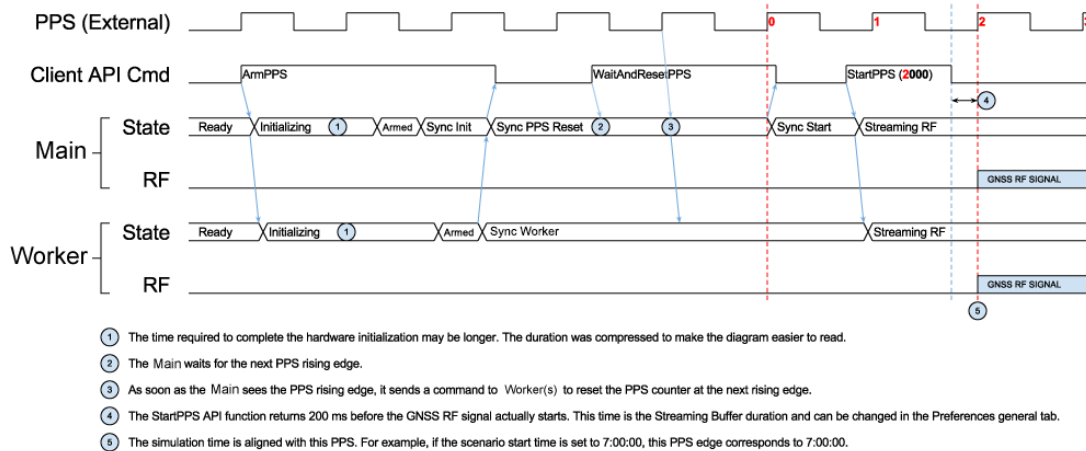

Figure 5-8: Main/Worker sync with user-defined PPS rising edge

When the Main receives the ArmPPS command, it automatically forwards the command to the Worker(s) and each Skydel instance commences the hardware initialization process. The Main Skydel instance will complete its own initialization and wait for each of the Workers to enter Sync state before entering the Sync PPS Reset state.



Note: The initialization may take more or less time depending on the hardware being used. See note 1 in above diagram.

Once the ArmPPS command returns, the client sends the WaitAndResetPPS command to the main Skydel instance. This command is blocking until the Main enters the Sync Start Time state.

When the Main receives the WaitAndResetPPS command (note 2), it waits for the next PPS rising edge (note 3). Immediately after this rising edge, Skydel knows that it has one full second to complete a time-critical process before the next rising edge. During that period of time, it will inform all Workers to use the next PPS rising edge as the reference PPS. Each Skydel instance resets the PPS counter on the same PPS rising edge. Once that task is completed, the main Skydel instance enters the Sync Start Time state.

Once the WaitAndResetPPS command returns, the client sends the StartPPS command with a delay relative to the reference PPS. This delay is specified in milliseconds.

Between the WaitAndResetPPS command and the StartPPS command, it is possible to change the scenario start time using the SetPpsOGpsTime. The start time sent will match the 0th PPS.

The StartPPS command returns 200 ms before the radios actually start transmitting the RF signal (note 4). The 200 ms is defined by the streaming buffer size in the general preferences (see "[General](#)" on page 33). The RF signal containing the GNSS signals commences at the exact moment defined in StartPPS command (note 5).

The Main/Worker synchronization also works with HIL trajectories as illustrated in the timing diagram below:

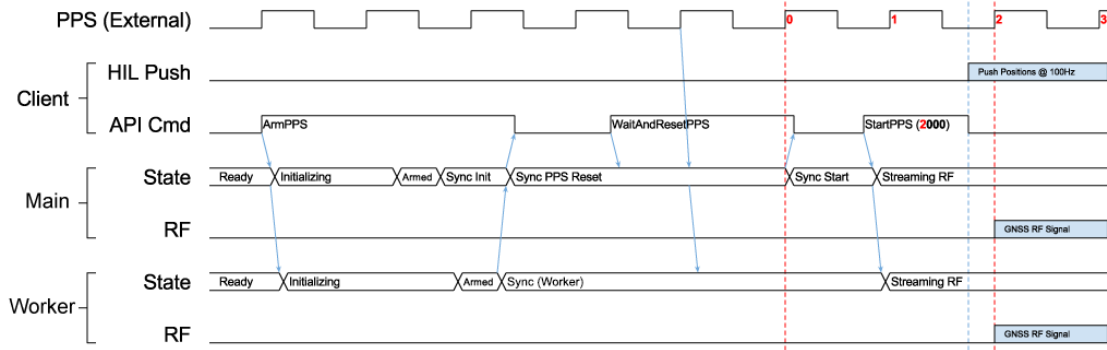

Figure 5-9: HIL and Main/Worker sync with user-defined PPS rising edge

The only difference is that when the StartPPS command returns, the client is expected to begin sending receiver positions for hardware-in-the-loop trajectories. It should start sending position for time=0s; this position corresponds to where the client tells the receiver to be at the precise moment that the RF streaming begins.

Tip: Sometimes we need to set the Main check box even if there is no Worker(s) connected. This is actually the only way to synchronize a GNSS RF Signal with an external PPS while using the HIL trajectory.

5.4 Timing Receiver Setup

To synchronize with the actual current time, Skydel needs to be connected with a GPS timing receiver, such as the OctoClock-G.

The flow is similar to " [Main/Worker Setup](#)" on page 265. The difference is that Skydel will go through an additional state called Sync Start Time. In this state, Skydel will poll the timing receiver to retrieve the current time and set the simulation start time to align the GNSS RF Signal with the GPS timing receiver time.

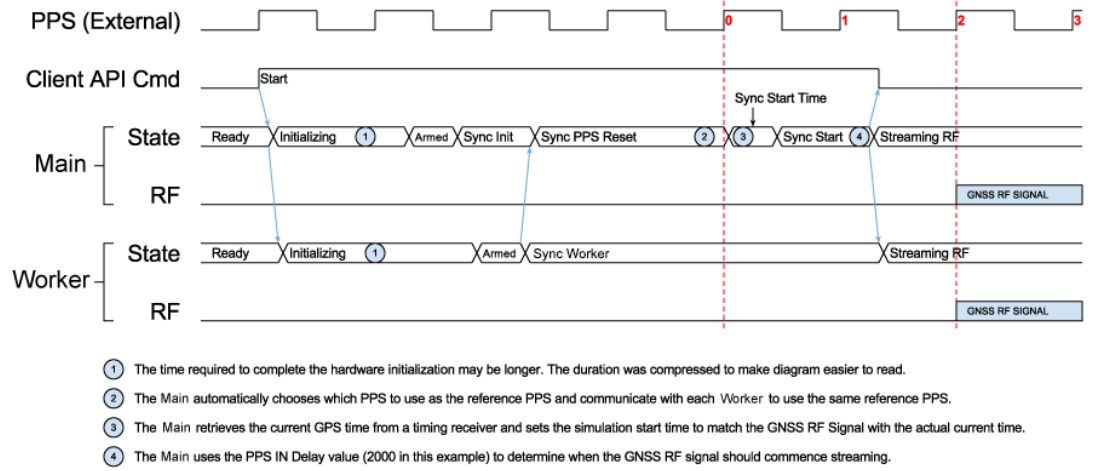

Figure 5-10: Sync with timing receiver

Note: The GPS timing receiver must be configured in the preferences.

5.5 Trigger (USRP X300 AUX I/O)

When using a X300, Skydel can take advantage of its GPIO to emit a trig signal. To do so, download the Safran GPIO trigger library that matches your operating system from the Skydel Driver/Firmware Page.

Note: This library was made using Safran’s GPIO API. This API is available as an option, for more information contact simulationsupport@nav-timing.safrangroup.com.

You then need to tell Skydel where to find the previously downloaded library in the preferences (see " USRP" on page 40).

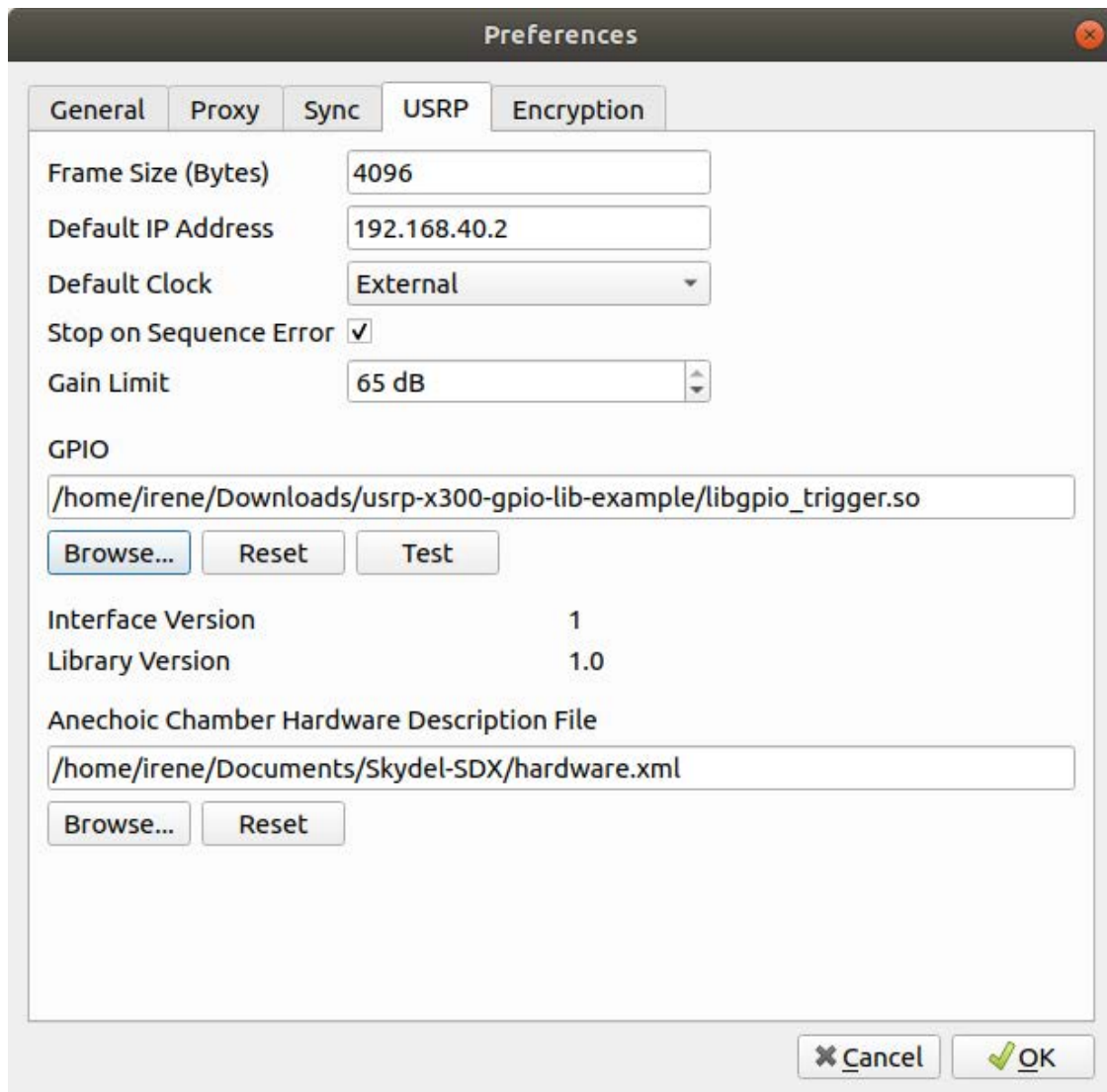

As long as this library is set here, the X300 radio will emit the following signals on its GPIO pins:

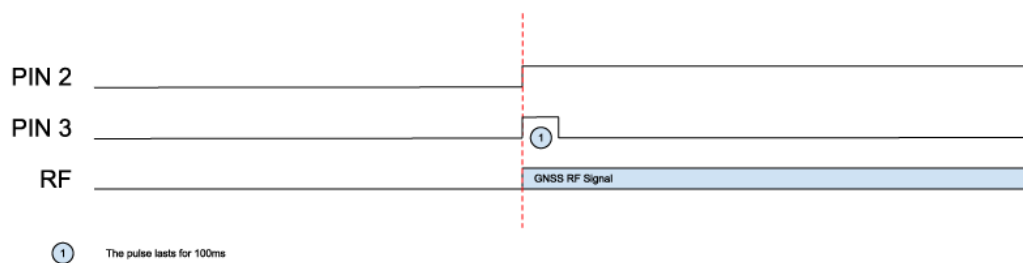

Pin 2 will stay high as long as RF is streaming and Pin 3 will be high only for 100ms.

The library source code is available and can be modified to control the pins with very accurate timing. It could be used to generate a 100 PPS signal of to trig event at specific moment during the simulation. The pins can be controlled in real-time or with a precise time stamp.

For pin numbering, refer to [Ettus documentation](#).

BLANK PAGE.

CHAPTER 6

Plugins

This chapter explains the concept, functioning, and details of plugins found within the Skydel application.

The following topics are included in this Chapter:

6.1 Introduction to Plug-ins	274
6.2 Rinex Observation Logger	278
6.3 Terrain Obscuration	280

6.1 Introduction to Plug-ins

Plug-ins extend Skydel's capabilities by accessing real-time simulation engine information to perform custom computing operations, while being integrated into the user interface.



Note:

Technically, a Skydel plug-in is a dynamic library (.so on Ubuntu and .dll on Windows). For more information on how to develop a plug-in, see the documentation here: <https://skydel.gitbook.io/skydel-plug-ins-documentation>

6.1.1 Management

Plug-ins are managed from the Plug-ins... dialog accessible through the Help menu:

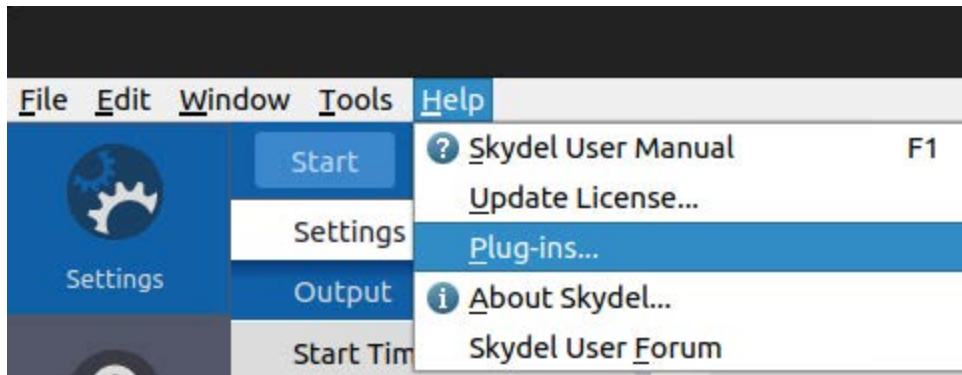

When launching the software, Skydel searches the Skydel Data Folder /Plug-ins, and returns a list of available plug-ins in the left pane. The right pane displays the selected plug-in's information, metadata, and implemented interface.

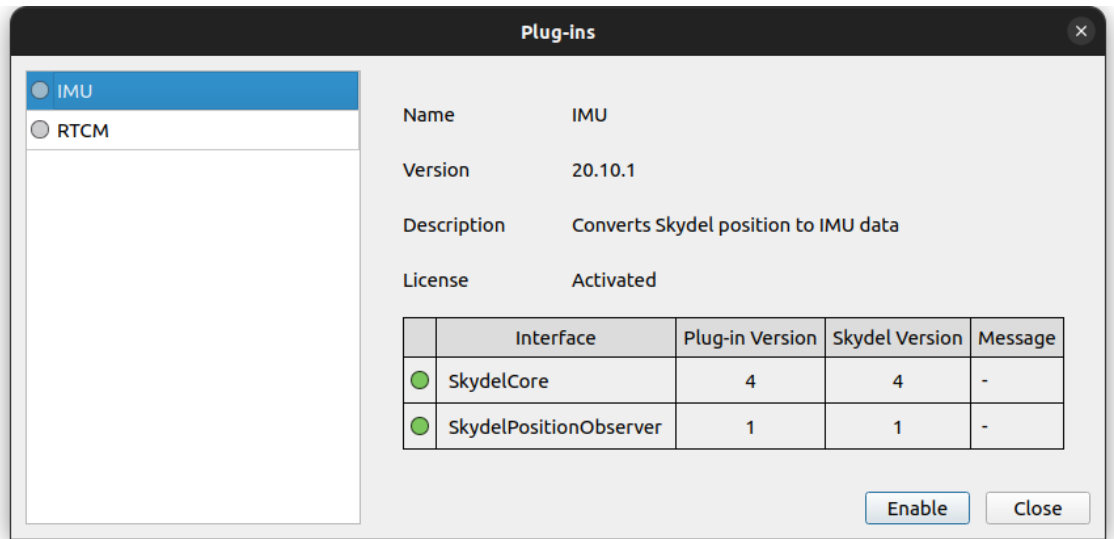

To enable a plug-in, click the Enable button. A green LED on the left pane for the associated plug-in will indicate that the plug-in is enabled.. To disable a plug-in, select the Disable button, which will display a grey LED.

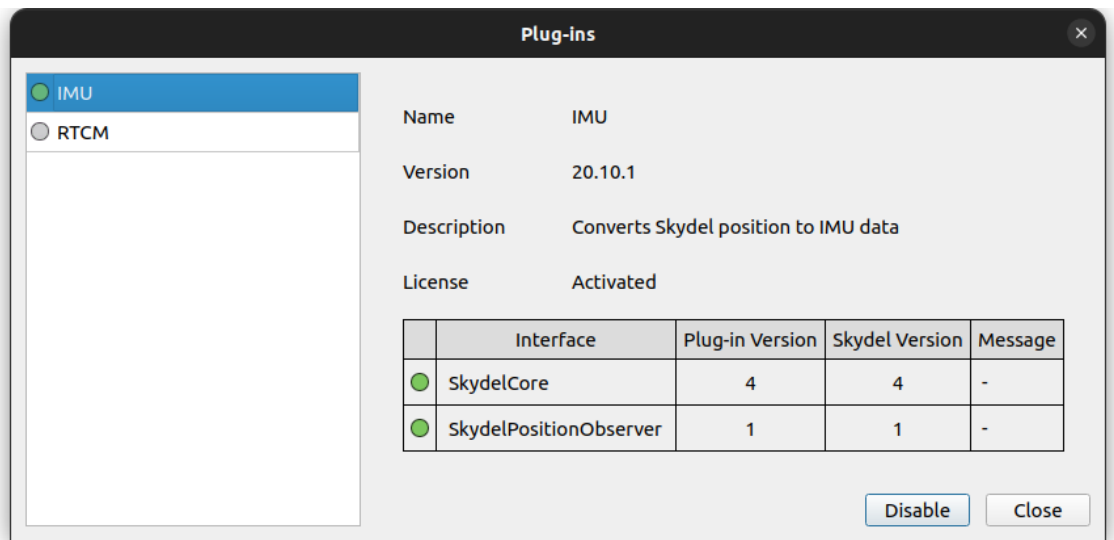

6.1.2 Incompatibility

If a plug-in is not compatible with Skydel, the LED on the left side panel will be red, and the interface table will explain why it may be incompatible.

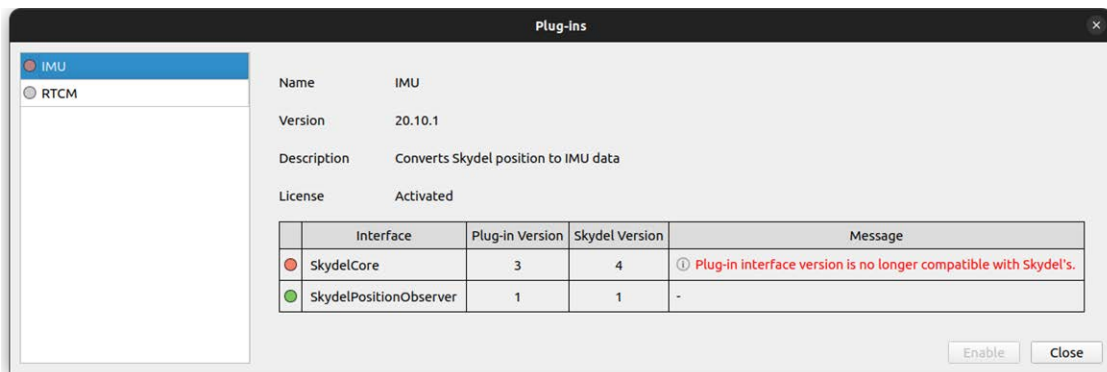

6.1.3 License Activation

Some plug-ins may require activation.

To activate a plug-in, select the Activate... button, and import the json file provided by the Safran support team.

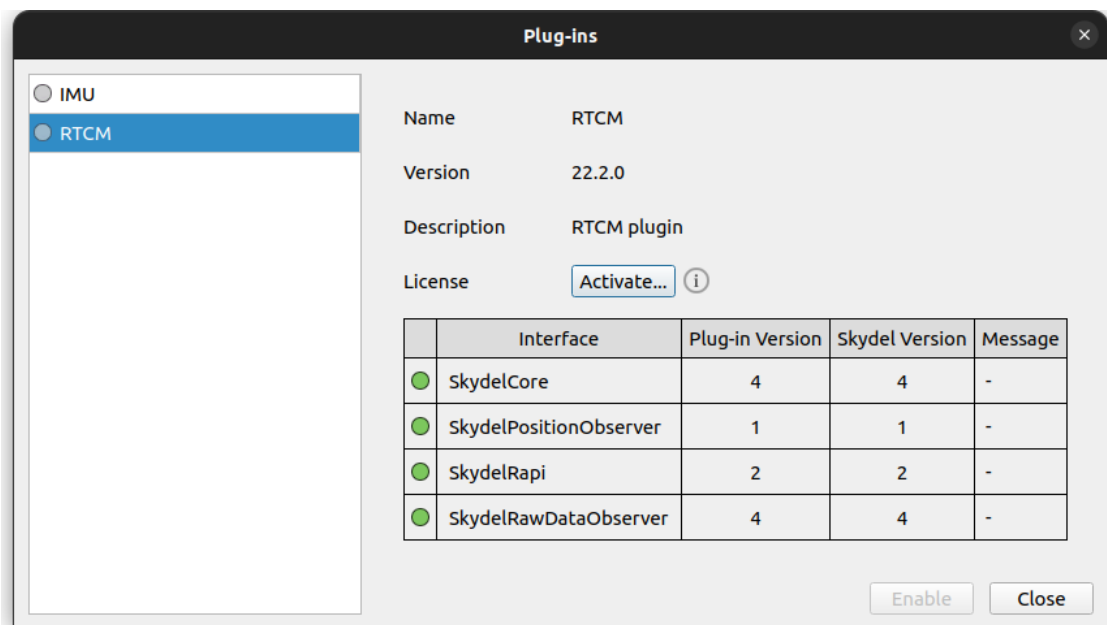

A successful activation will result in an Activated license status, and the ability to enable the plug-in.

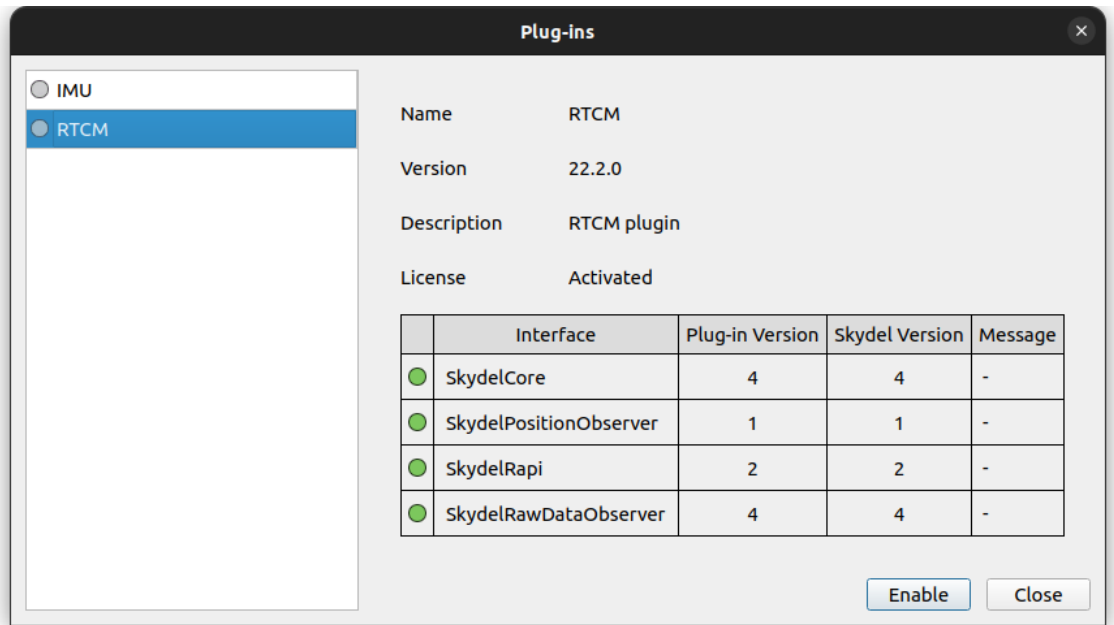

If for some reason a plug-in that requires a license activation has a red LED in the left pane, it's likely due to its license file is incompatible with the current system. Simply reselect Activate... with the appropriate license file to properly activate the plug-in.

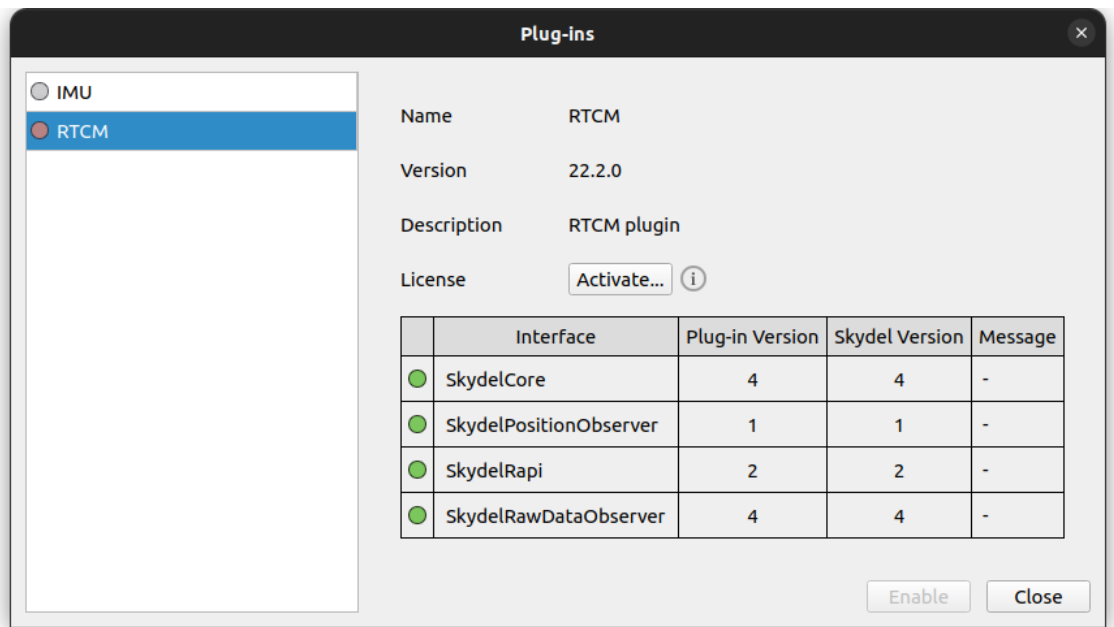

6.2 Rinex Observation Logger

6.2.1 Introduction

The **Rinex Observation Logger Plug-in** allows users to generate RINEX observation files that are populated during runtime. The plugin is designed to directly integrate into Skydel the same functionalities provided by the external Skydel tool SROG (Skydel Rinex Observation Generator).

The files follow the RINEX V4.00 standards found at https://files.igs.org/pub/data/format/rinex_4.00.pdf ↗

Currently, the mixed option generating one observation file for all active constellations is not supported. This plug-in generates one file for each active constellation.



Note: Currently, you cannot configure the log sampling rate. It is set to 1 record for each 30 seconds. In addition, users cannot set the logging folder – it is set to the Rinex Observation Logger folder under the output folder of the simulation.

6.2.2 Management

Firstly, ensure that the plug-in is enabled. Go to the Help menu, then Plug-ins... and locate the **Rinex Observation Logger Plug-in** in the list.

Click the Enable button. A green LED on the left pane will indicate that the plug-in is enabled.

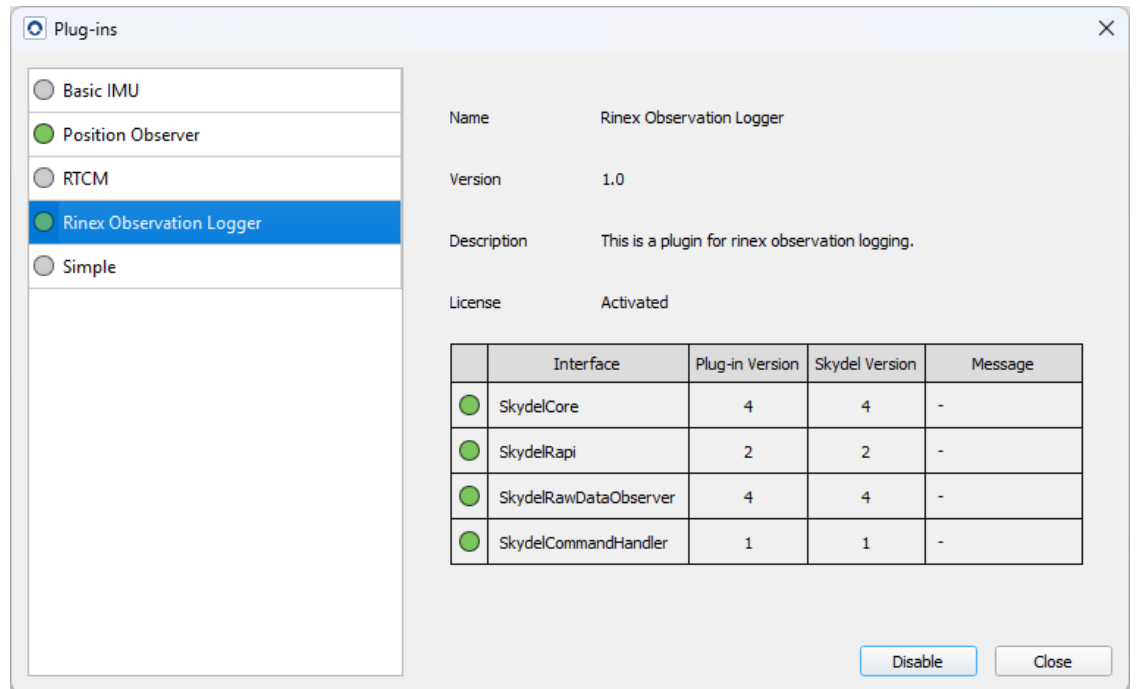

To activate the logging, go to the **Settings - Global - Logging** menu. Check the RINEX Logging check box. This will activate the logging for both the RINEX observation and navigation files.

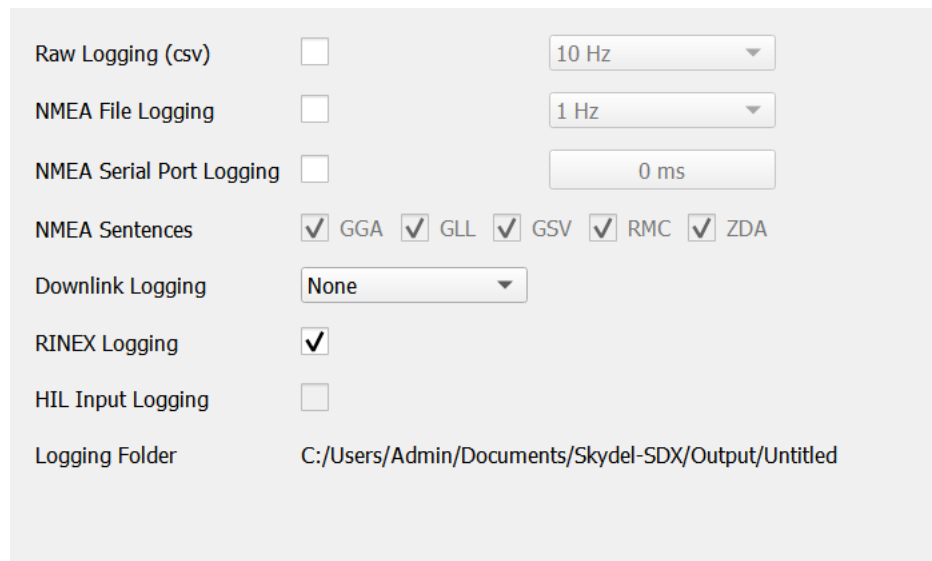

Now you can set the outputs for the simulation. For example: NoneRT with GPS L1/CA

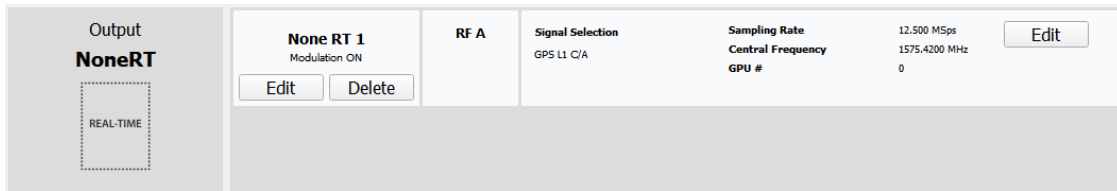

Finally, press Start to begin the simulation, and Stop once the simulation when finished.

The generated RINEX files will be located in the following directory: Skydel-SDX\Output\

6.2.3 Details

Not all fields from the header are logged in the observation files. Below is a list of the logged fields.

- » RINEX VERSION / TYPE
- » PGM / RUN BY / DATE
- » MARKER NAME
- » MARKER NUMBER
- » OBSERVER / AGENCY
- » COMMENT
- » REC # / TYPE / VERS
- » ANT # / TYPE
- » APPROX POSITION XYZ
- » ANTENNA: DELTA H/E/N
- » SYS / # / OBS TYPES
- » TIME OF FIRST OBS
- » END OF HEADER

6.3 Terrain Obscuration

6.3.1 Introduction

Skydel can simulate terrain obstruction effects on jamming, spoofing, and GNSS signals. Please note that simulating jamming and spoofing with terrain effects requires the **Advanced Jamming** and **Spoofers** features, respectively. The Terrain settings are located in the Settings - Global - Terrain menu.



Note: Terrain effects are simulated by a plug-in. If you don't see the Terrain menu, make sure the Terrain plug-in is enabled in the Plug-ins dialog under the Help menu.



Caution: In addition to the minimum system requirements, the Terrain plug-in requires an extra 625 MB of RAM.

6.3.2 General

Enable	<input checked="" type="checkbox"/>
Update Rate	Auto ▾
Elevation Data Path	<input type="text" value="\$HOME/Documents/SRTM"/> <input type="button" value="Browse..."/>

- » **Enable:** Controls whether terrain effects are simulated or not.
- » **Update Rate:** Specifies the frequency at which terrain effects are applied to each signal. In Auto mode, the system starts at the maximum update rate (50 Hz) and reduces it automatically if computations cannot be completed in time. When a fixed rate is selected, the system displays a warning message in the Status Log whenever signals cannot be updated in time. Note that the simulation is automatically stopped when the update rate fails to be maintained for five consecutive seconds.
- » **Elevation Data Path:** Specifies the folder that contains SRTM 1 Arc-Second Elevation Data files (HGT zip files). If a required elevation data file cannot be found at runtime, the system will display a warning message in the Status Log and use an elevation of 0 for that area by default.

Because of their large size, elevation data files are not included with Skydel by default. If you only need to perform a quick test of the plug-in, you can download the elevation data surrounding the vehicle's default position from the [Skydel users website](#) then extract the archive to a convenient location, and set the Elevation Data Path to that folder. For instructions on how to download the complete dataset or specific regions, see the procedure below.

6.3.3 Visualizer (Interference/Spoofers)

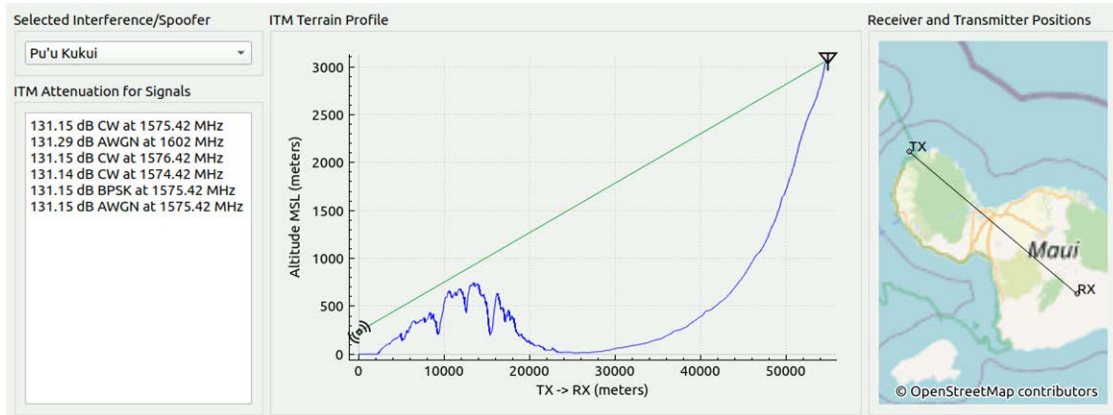

This page dynamically displays the terrain profile between the transmitter and receiver, along with their relative positions on a map during a simulation. By default, the map automatically follows transmitter and the receiver. However, you can zoom-in on an area using the mouse wheel or display a specific region by dragging the map with the left mouse button. To restore the automatic view, simply right-click anywhere on the map.

The emitter icons on the left side of the terrain profile shows the transmitter's altitude relative to the ground, while the antenna icon on the right side indicates the receiver's altitude above ground level. The line connecting the two icons appears green when there is a clear (geometrically unobstructed) line of sight (LOS) between the transmitter and receiver, and orange when it intersects the terrain (geometrically blocked). Hovering over the transmitter icon displays its azimuth and elevation angles, along with its name and visibility status. The graph can be flipped (horizontally) by double-clicking on the x-axis label. As with the map, you can zoom in on the graph using the mouse wheel and drag it with the left mouse button. To restore the automatic axis scaling, right-click anywhere on the graph.

The dropdown menu in the top-left corner selects which transmitter's data is shown, and the text box below lists the attenuation for each of its signals. Signal attenuations are computed using the Irregular Terrain Model (ITM) developed by Anita Longley and Phil Rice of the Institute for Telecommunication Sciences.



Note: The LOS shown in the terrain profile is purely geometric and provided for reference only. ITM calculations internally account for Earth curvature and propagation effects. As a result, the green or orange LOS coloring does not directly indicate signal availability. To assess signal availability, users should rely on the ITM attenuation values shown on the left, not the LOS coloring.

6.3.4 Visualizer (GNSS)

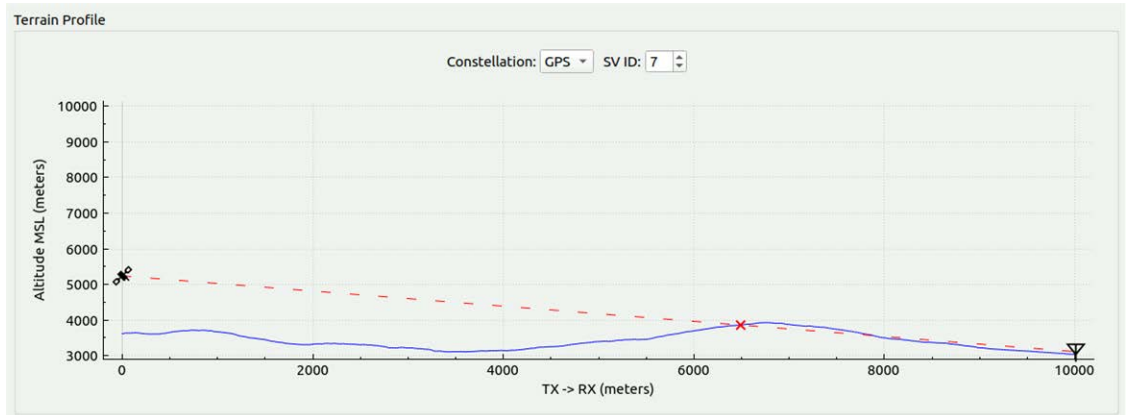

This page follows the same principles and interactions as the Visualizer for Interferences (elevation profile, LOS indication, zooming and panning behavior, automatic scaling, etc.), but with the following differences:

- » **No map display:** The GNSS visualizer does not include a map view. Only the terrain profile and related controls are shown.
- » **Constellation and Space Vehicle selection:** The transmitter/spoofers dropdown is replaced by:
 - » A **constellation** combobox (e.g., GPS, GALILEO, GLONASS, BEIDOU), and
 - » A **space vehicle (SV)** spinbox.

Entering the ID of a non-visible satellite clears and deactivates the Terrain Profile.

- » **No attenuation display:** Unlike the interference visualizer, there is no dropdown listing signal attenuation values. In the GNSS case, attenuation is not computed for obstructed paths.

Instead, visibility is handled as a binary condition:

- » If the geometric line of sight is obstructed, the signal is turned **OFF**.
- » If the line of sight is clear again, the signal is turned **ON**.
- » **SV icon:** The emitter icon on the Terrain Profile is replaced with an SV icon. Hovering over the icon displays the SV's azimuth and elevation with respect to the receiver.

As with the interference visualizer, the LOS indication in the terrain profile remains purely geometric and is used to determine whether the satellite signal is enabled or disabled.

6.3.5 Limitations

- » Scenarios must be within -56 and 60 degrees of latitude (no elevation data is available outside this region).
- » The vehicle is not automatically adjusted to remain above ground level. Users must manually modify its trajectory to ensure it does not go below the ground level.
- » GNSS Signals are only turned ON or OFF (no signal propagation model is used).
- » SV obscurations are simulated only within 10 km of the receiver.
- » SV obscurations are simulated using flat terrain profiles (effects such as Earth curvature and atmospheric refraction are not modeled).
- » Jammers and spoofers must be located within 100 km of the receiver.
 - » To compute the attenuation of jamming and spoofing signals, the receiver and transmitters must always be positioned between 0.5 and 3000 meters above ground level.

6.3.6 Downloading SRTM 1 Arc-Second Elevation Data

The plug-in uses NASA's SRTM 1 Arc-Second elevation data to generate the terrain profiles. Because the full dataset spans several gigabytes, it cannot be included with the software. The steps below explain how to download the necessary data (HGT zip files) on Ubuntu and how to configure the plug-in to use it.



Note: The download procedure on Windows is almost identical. However, we have observed some instability. For this reason, we strongly recommend downloading the files on Ubuntu and then transferring them to Windows.

1. Open a web browser and navigate to NASA's Earth Data website: <https://urs.earthdata.nasa.gov>

2. Create a free account and login.

EARTHDATA LOGIN

Username

Password

Stay signed in (this is a private workstation)

LOG IN

Need Help?

• [Forgot Username](#) • [Forgot Password](#)

Why must I register?

The Earthdata Login provides a single mechanism for user registration and profile management for all EOSDIS system components (DAACs, Tools, Services). Your Earthdata login also helps the EOSDIS program better understand the usage of EOSDIS services to improve user experience through customization of tools and improvement of services. EOSDIS data are openly available to all and free of charge except where governed by international agreements.

REGISTER FOR A PROFILE

Feedback

3. Navigate to NASA's Earthdata Search page: <https://search.earthdata.nasa.gov>
4. In the search box at the center of the page, enter "NASA Shuttle Radar Topography Mission Global 1 arc second V003", and click Search.

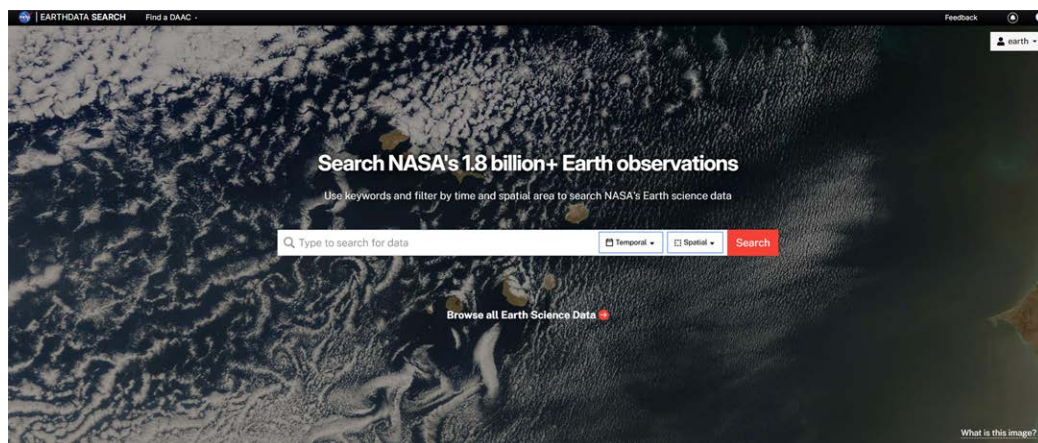

5. On the next page, click on "NASA Shuttle Radar Topography Mission Global 1 arc second V003" in the search results.

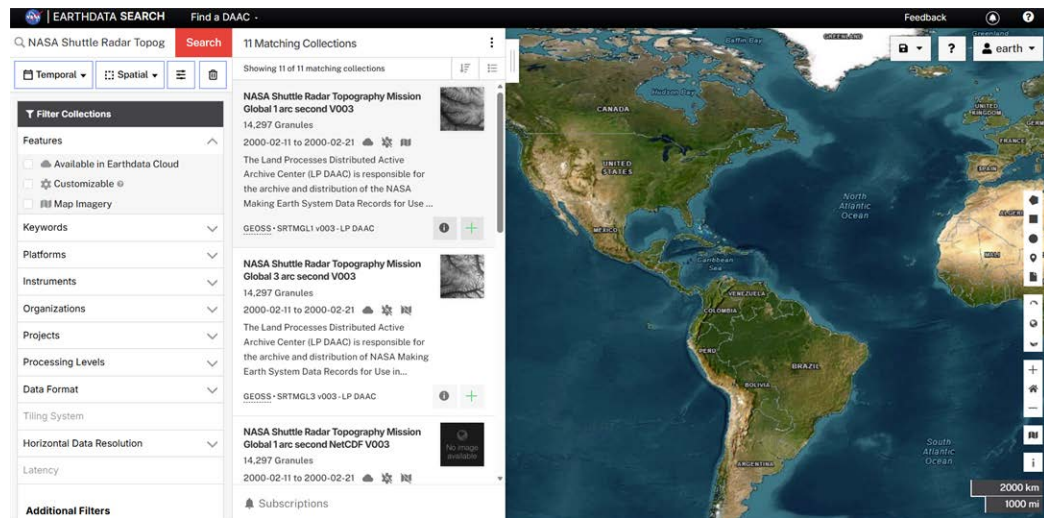

- On the dataset page for NASA Shuttle Radar Topography Mission Global 1 arc second V003, click Download All at the bottom of the screen.

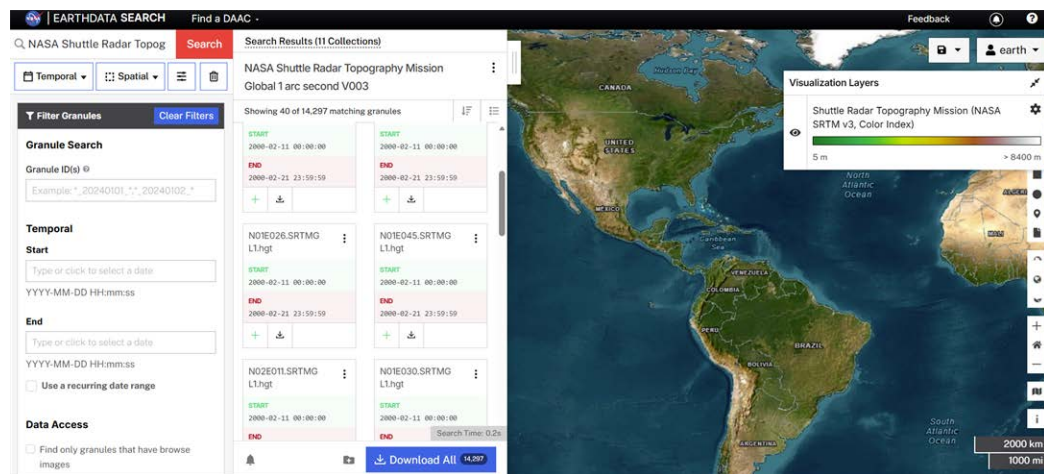

- This creates a new untitled project in NASA's Earthdata Search tool that includes all the SRTM data. To download the data, click Download Data at the bottom left of the page.

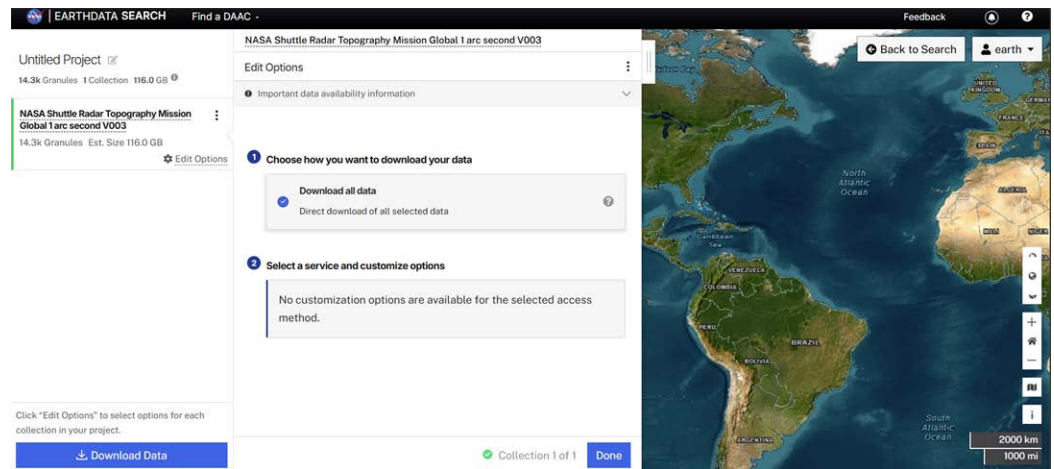

- Click the Download Script tab and copy the script shown at the bottom of the page.

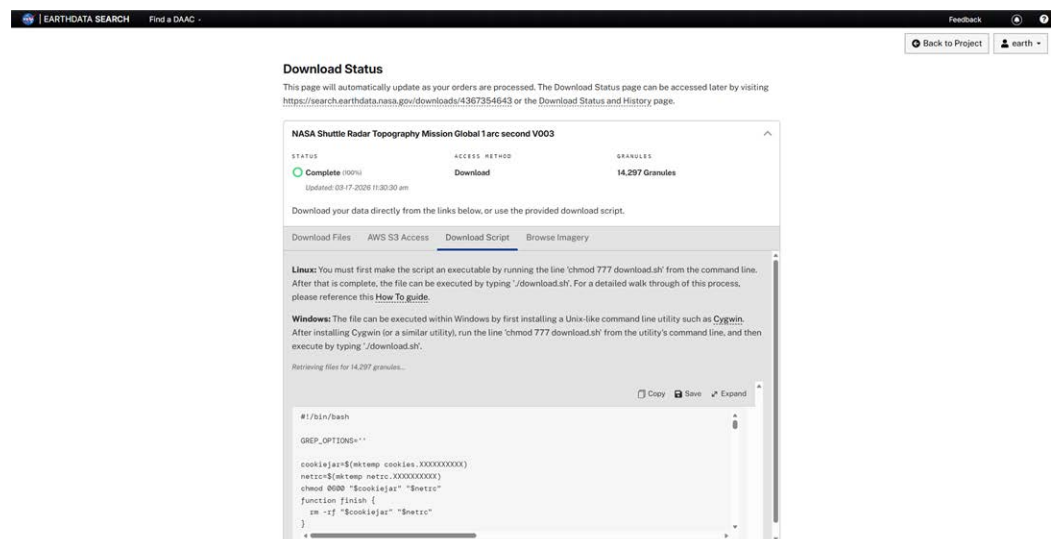

- In the folder where you want to download the data, create a new file named "download.sh", paste the script into it, then save and close the file.
- Open a terminal window in the same folder and change the file's permissions by running the following command: `chmod 777 download.sh`
- Run the script by typing `./download.sh` and pressing Enter.
- When prompted, enter your NASA username and password. The files will then begin downloading.
- To use the files in Skydel, open the Settings - Global - Terrain - General menu and set the Elevation Data Path the folder containing the HGT ZIP files downloaded at the previous step.



Caution: Ensure that the files remain in ZIP format as the application reads the data directly from these archives. Also, do not rename files as this may prevent the application from locating them.

CHAPTER 7

Software Installation

This section is for users that purchased the **software-only version of Skydel**. Users who purchased a turnkey solution will already have their software, OS, and drivers properly configured.

The following topics are included in this Chapter:

7.1 Software Configuration: Linux Ubuntu	290
7.2 Skydel-SDX Folder	295

7.1 Software Configuration: Linux Ubuntu

Supported versions:

- » Ubuntu 18.04 LTS
- » Ubuntu 20.04 LTS
- » Ubuntu 22.04
- » Ubuntu 24.04.1 LTS



Tip: You can perform Ubuntu 18.04, 20.04 LTS, 22.04, and 24.04.1 LTS package updates with the following commands. This will ensure you get the most recent Ubuntu security patches, and assure packages are upgraded in consistent manner:

```
sudo apt update
sudo apt dist-upgrade
```

7.1.1 General Parameters

Screen Privacy & Security

In the Ubuntu Settings, select the Privacy & Security tab, then Screen Lock. Set “Blank Screen Delay ” to “Never”, and disable the “Automatic Screen Lock” option. This will avoid interrupting the simulation when there is no user interaction with the computer.

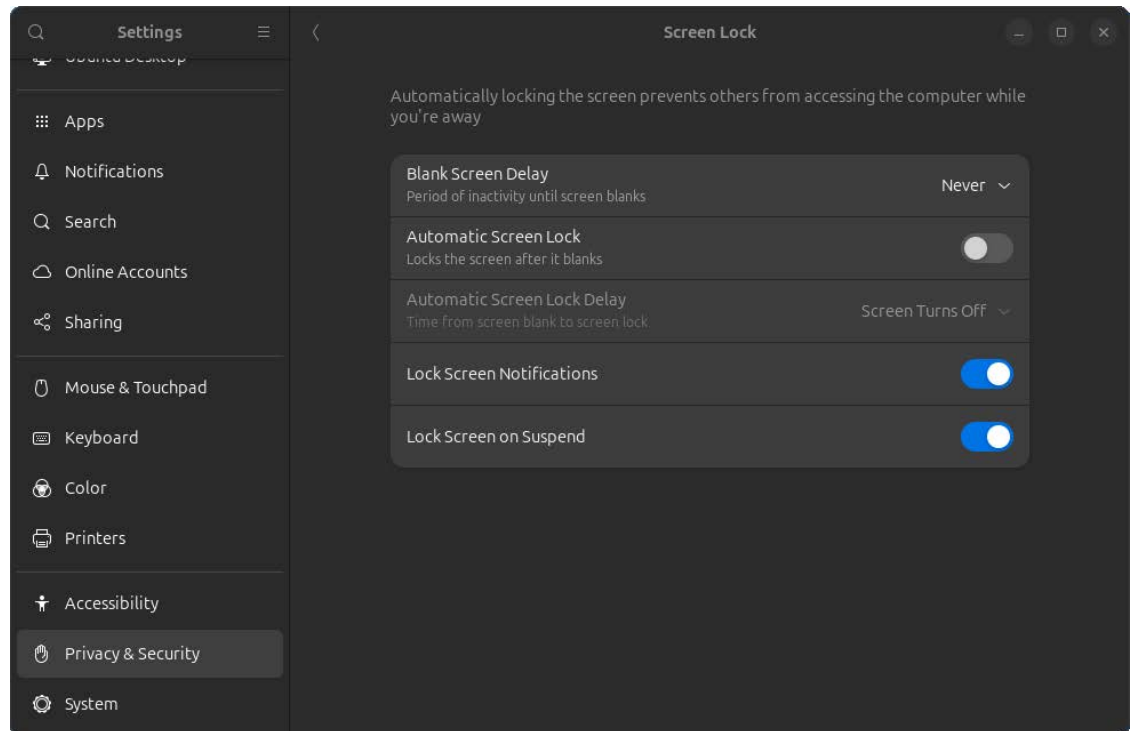

Real-Time Priority of Threads

Skydel uses processing threads that need to run at the “real-time” priority level. In order to use this priority level, the Linux user must have rights to change the thread priorities. With root rights, edit the file `/etc/security/limits.conf`, and add the following line:

```
<username> - rtprio 99
```

Dialout Group

Skydel can be connected to a GNSS receiver through a serial port in order to get the NMEA data. To be able to access the serial port, the Linux user needs to be in the `dialout` Linux group. You can add the user to this group by executing this command in a terminal window:

```
usermod -a -G dialout $USER
```

7.1.2 Nvidia GPU Driver

The installed Nvidia graphics card driver must support CUDA Runtime API 12.6.77 or higher. The Nvidia driver version must be 550.107.02 or higher.



Caution: For Ubuntu 18.04, 20.04, 22.04, and 24.04.1 Safran recommends using the "Nvidia proprietary driver", which can be installed from Ubuntu's "Software & Updates." See below.

7.1.2.1 Nvidia GPU Driver for Ubuntu 18.04, 20.04, 22.04, and 24.04.1 (Automatic)

Step 1

Ensure that your Ubuntu system is connected to the Internet.

Step 2

Add ppa:graphics-drivers/ppa repository to apt. Execute the following commands:

```
sudo apt-add-repository ppa:graphics-drivers/ppa
sudo apt update
```

Step 3

Open Ubuntu's "Software & Updates" window from Ubuntu's "System Settings". Click on the "Additional Drivers" tab.

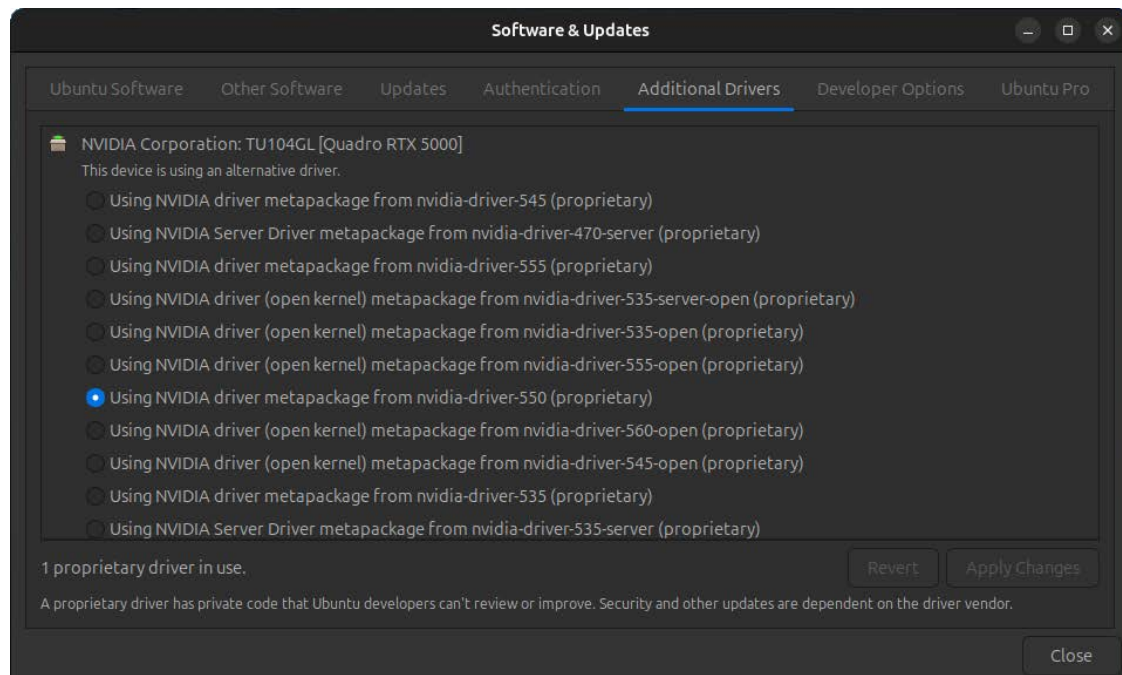

Step 4

Select "Using NVIDIA binary driver", and click "Apply changes". Once the installing is completed, reboot the computer such that the new driver is used by Ubuntu.



Note: If you previously manually installed an Nvidia driver, you might be unable to select the "Using NVIDIA binary driver". In that case, you can execute the next alternate steps

Alternate Step 4a

Execute the following command:

```
sudo ubuntu-drivers devices
```

Alternate Step 4b

From the output of the command, locate a line showing "driver : nvidia-driver-xxx", where xxx is the Nvidia driver version. Then, execute the next command:

```
sudo apt-get install nvidia-driver-xxx
```

Alternate Step 4c

Reboot the computer. The nvidia-xxx driver will now be used.



Note: Nvidia drivers are frequently updated. If the above procedure is not successful, please refer to the Skydel user forum. If you are still unable to find a solution, we encourage you to post your question/issue on the forum for a prompt response.



Resources: [Updating NVIDIA Drivers Offline \(Ubuntu\)](#)

7.1.2.2 Network Card Driver: 10 GbE Intel X520-DA2

Only required to operate Ettus X300/X310; NI USRP-294xR/295xR SDR.

Update the Driver

For 18.04 and 20.04 LTS, the driver installed by default is perfectly functional; there is no need to update it.

Configure Network Parameters

Open the Network Configuration Settings window and edit the settings of the network card connected to the USRP device:

- » set the “MTU” size to 9000;
- » in the IPv4 settings, set a static IP address: Address=192.168.40.1; Net-mask=255.255.255.0; Gateway=0.0.0.0
- » the computer must be configured to use the maximum socket buffer size: With root rights, edit the /etc/sysctl.conf file, and add the following lines:

```
net.core.rmem_max=33554432
net.core.wmem_max=33554432
```



Tip: To ensure that changes are applied, perform a logoff/logon of the Ubuntu user.

7.1.2.3 Dektec Drivers

You can find the Dektec drivers for the DTA-2115B and DTA-2116 on Dektec’s web site: www.dektec.com/downloads/SDK The Dektec drivers are included in the “Linux SDK” package. Simply follow the instructions included with the download, in order to compile and install the driver.

Please note that if you update the Ubuntu kernel of your system, you will need to re-compile and re-install it again.

7.1.2.4 Safran Skydel Installation

Before installing Skydel, make sure you remove any previous version(s) by executing the following command:

```
sudo dpkg -r skydel-sdx
```

To install the new version of Skydel, execute the following commands (note: rename the .deb file name according to the version that you want to install):

```
sudo dpkg -i skydel-sdx-YY.MM.X-YYYYYYYH.deb
sudo apt-get install -f
```

The second command will install any missing dependencies required by Skydel. Usually, the missing dependencies are libboost, libblas-common, libblas3, libgfortran3, libgstreamer-plugins-base0.10-0, and libgstreamer0.10-0 liblapack3.

skydel-sdx will be installed in /usr/bin.

All libraries will be installed in /usr/lib/skydel-sdx.

After having started Skydel for the first time, you will find a Skydel-SDX folder inside your Documents folder. See the [“Skydel-SDX Folder” on the facing page](#) section for a detailed explanation of each folder’s contents.

7.2 Skydel-SDX Folder

Once you have started Skydel for the first time, you will find a “Skydel-SDX” folder inside your Documents folder.



Note: You can customize the location of the Skydel-SDX folder in the “ Preferences” on page 32.

Folder or File	Description
Skydel-SDX/	Safran Skydel root folder
Skydel-SDX/API/	Remote API open- source libraries and examples
Skydel-SDX/API/Cpp/	Remote API in C++
Skydel-SDX/API/CSharp/	Remote API in C#
Skydel-SDX/API/Python/	Remote API in Python
Skydel-SDX/API/Documentation.txt	Remote API documentation
Skydel-SDX/Automate/	Folder where Skydel scripts (.sdxscript) files are stored
Skydel-SDX/Configurations/	Default folder where Skydel configurations are stored. This folder also contains scenario and trajectory examples.
Skydel-SDX/Output/	Folder where raw data, NMEA and I/Q sample files are written by Skydel
Skydel-SDX/Plug-in/	Folder where Skydel search in order to list all the available plug-ins
Skydel-SDX/Templates/	Default folder where almanacs and ephemeris are accessed by Skydel. This folder also contains basic antenna models that can be used in your scenario.
Skydel-SDX/simulator.log	The Skydel log file. Very useful when requesting assistance from Safran support.

BLANK PAGE.

APPENDIX

Appendix

The following topics are included in this Chapter:

8.1 Technical Support	298
8.2 References	298
8.3 IQ Files	299
8.4 Important changes introduced in version 21.3	301
8.5 NMEA Serial Port Logging	306
8.6 List of Tables	311
8.7 List of Images	311

8.1 Technical Support

To request technical support for Skydel or your GSG-8 Gen2, please go to the ["Skydel Support" page](#) of the Safran website, where you can not only submit a support request, but also find additional technical documentation.

Phone support is available during regular office hours under the telephone numbers listed below.

Thank you for your cooperation.

8.1.1 Regional Contact

Safran operates globally and has offices in several locations around the world. Our main offices are listed below:

Country	Location	Phone
France	Les Ulis	+33 (0)1 6453 3980
Spain	Granada	+34 958 285 024

Additional regional contact information can be found on the [Contact page](#) of the Safran Trusted 4D website.

8.2 References

8.2.1 Safran Skydel Download Page

Contact Safran (simulationsupport@nav-timing.safrangroup.com) to get user name and password to access the Skydel download page.

URL: users.skydelsolutions.com

8.2.2 Skydel Driver/Firmware Page

This page contains download links for drivers and firmware, which may be required for Skydel operation.

Contact Safran (simulationsupport@nav-timing.safrangroup.com) to get a user name and password for access. Note: This is the same user name and password as for the Safran Skydel Download Page.

URL: users.skydelsolutions.com/drivers-and-firmwares ↗

8.3 IQ Files

8.3.1 IQ File Data Format

The IQ File uses the extension .iq and contains the raw 16-bit IQ samples in binary format. The file has no header. The first 2 bytes is the integer value for I, the following 2 bytes is the integer value for Q. The pattern simply repeat I,Q,I,Q,I,Q, etc. The integer format is in little endian.

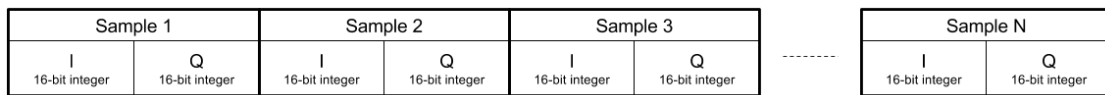

8.3.2 IQ File Metadata

This files uses the extension .xml and is consistent with the [GNSS SDR Metadata Standard](#). It contains multiple fields describing how the .iq file should be read including the sampling rate and center frequency of the signal.

8.3.3 Importing an IQ File

For Skydel to correctly use the binary IQ-Samples file (ex: my-waveform.iq), a metadata file respecting the [GNSS SDR Metadata Standard](#) must be found in the same folder (ex: my-waveform.xml). When using this standard, only metadata files with one Lane, System, Block, Chunk, Lump, Stream, Band and File are supported by Skydel.

Furthermore, the metadata must have the following values:

Chunk Key	Value
sizeword	2

Chunk Key	Value
countwords	2
endian	Little
padding	None
wordshift	Left

Stream Key	Value
ratefactor	1
quantization	16
packedbits	32
format	IQ
encoding	INT16

Band Key	Value
translatedfreq	0
delaybias	0

Skydel also supports the use of a text file as a metadata file (ex: my-waveform.iq.desc). This metadata file simply contains "Key-Value" pairs to describe the waveform. Here are the supported keys:

Key	Value	Unit	Requirement
CENTRAL-FREQUENCY	1575420000	Hz	MANDATORY
SAMPLE-RATE	12500000	Samples per sec	MANDATORY

The text file must contain 1 Key/value pair per line. For example:

- » CENTRAL-FREQUENCY=1575420000
- » SAMPLE-RATE=12500000

8.4 Important changes introduced in version 21.3



Caution: There are important changes introduced in Skydel version 21.3. Users upgrading from 20.9 or older to 21.3 or newer should read this appendix carefully.

Until version 20.9, PRN was used as primary key to identify a GNSS satellite. This is replaced in 21.3 with the space vehicle identifier, or **SV ID**. This method is more robust for several reasons:

- » The SV ID is constant, while the PRN may change.
- » Different signals from the same satellite may use different PRNs.
- » For testing purposes, you may need to assign the same PRN to different satellites which makes the PRN ambiguous.

In many situations, the SV ID and PRN values are the same by default. But for QZSS and SBAS they differ. For QZSS, it may even differ on a signal basis.

Constellation	SV ID	Default PRN
GPS	1-32	1-32
GLONASS	1-24	1-24
GALILEO	1-36	1-36
BEIDOU	1-63	1-63
SBAS	1-39	120-158
QZSS L1S, L5S	1-10	183-192
QZSS C/A, L1C, L5	1-10	193-202

Constellation	SV ID	Default PRN
NAVIC	1-14	1-14
PULSAR XL	1-258	1-258
PULSAR X1	1-258	1-20



Caution: The SV ID used by Skydel is an index. It is not the same as the satellite numbering used in ICDs. For example, GPS will use satellite No. or SVN which has a different meaning. Skydel SV ID is relevant only within Skydel software.

8.4.1 SV ID used in the GUI

The first noticeable changes in the GUI are in the settings pages such as GPS>Orbits and in the Constellations subtab as shown in the image below.

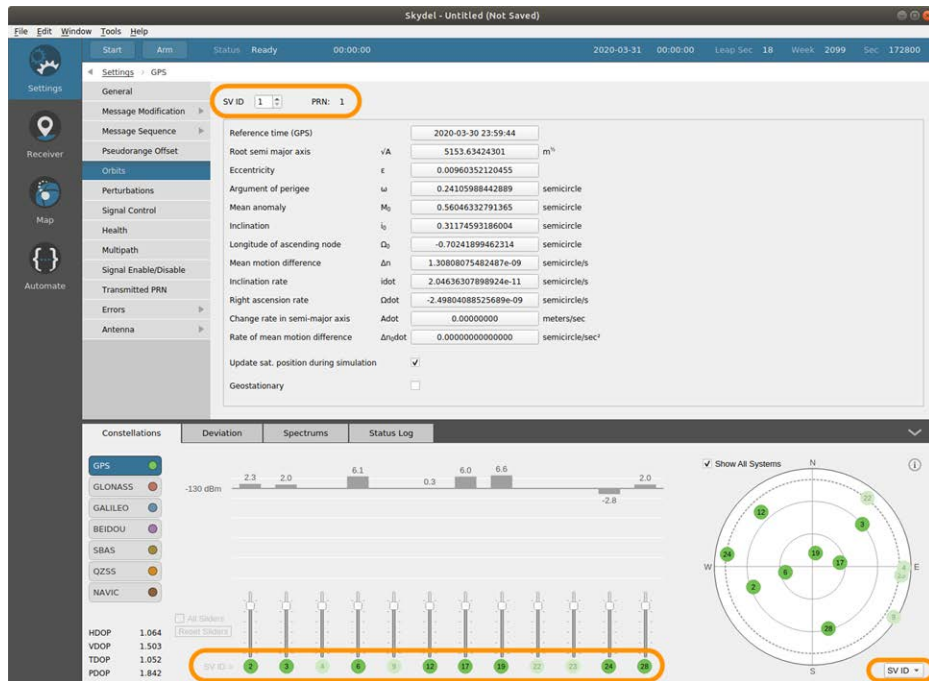

Figure 8-1: Skydel showing SV ID instead of PRN

In this image, notice 3 important changes:

- » At the top of the screen, the SV ID spin control replaces the PRN spin control. The PRN itself is shown just beside the SV ID. Note the PRN and SV ID have the same value, which is typical for most constellations, but not all of them.
- » At the bottom left of the screen, the power sliders are identified with numbers; these are now SV IDs.
- » At the bottom right in the sky view, the satellites are also numbered with SV IDs but there is a dropdown list where you can switch from SV ID to PRN. Note that showing PRN instead of SV ID will affect only the sky view and not the rest of the GUI.

For GPS, SV ID and PRN use the same value by default. For other constellations, like QZSS, the changes are more consequential. The image below shows the same settings but for QZSS.

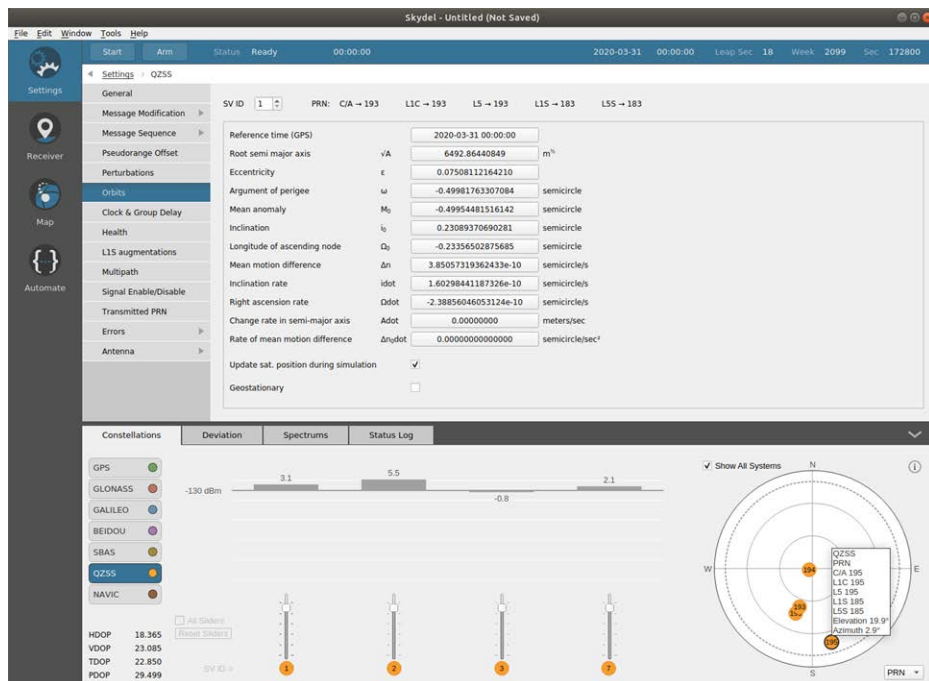

Figure 8-2: Skydel showing SV ID instead of PRN for QZSS

This time, we can see at the top of the screen that for SV ID 1, there are different PRNs used. In the sky view, when selecting the PRN in the dropdown list, the tooltip shows the PRN for all QZSS signals.

Another example, where SV ID is used instead of PRN, is where you can actually change the PRN being transmitted for each signal as shown in the following image.

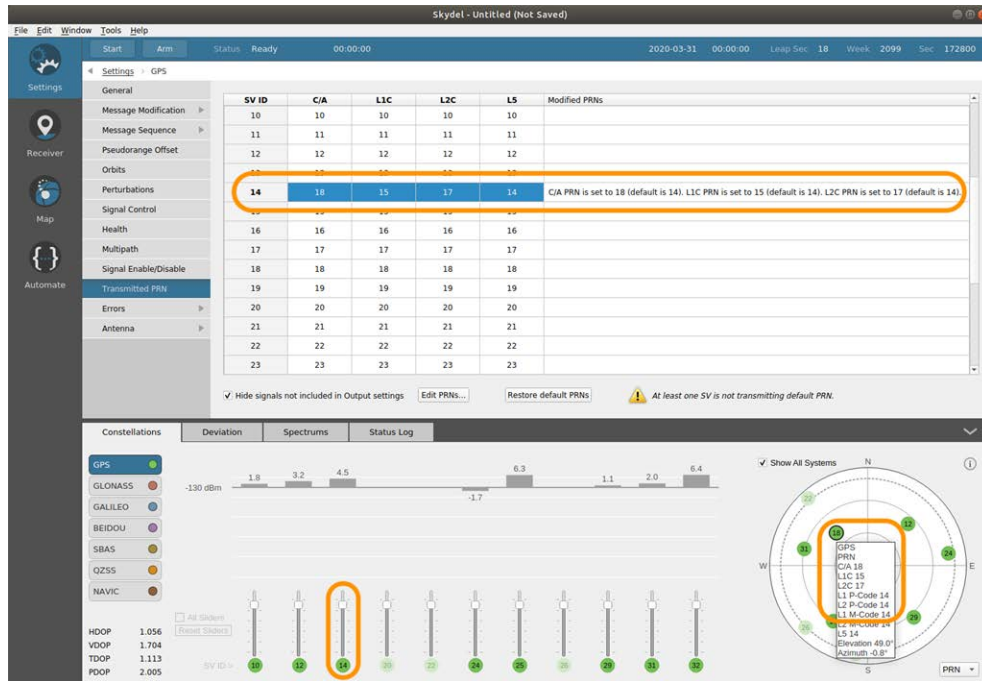

Figure 8-3: Skydel showing SV ID with multiple PRNs

As you can see, SV ID 14 uses different PRNs in this example. It uses PRN 18 for the C/A signal, 15 for L1C, and so on. The power slider still uses the SV ID. This demonstrates the need to use SV ID instead of PRN to avoid confusion.

These changes are visible in the user interface but more importantly, they affect many commands in the API.

8.4.2 SV ID used in the API

In version 21.3, certain commands were changed to replace PRN with SV ID as the primary key. Older commands are deprecated so they continue to work for backward compatibility, but they will eventually be removed from the API. For new projects, deprecated commands should be avoided.

At the same time that PRN was replaced with the SV ID, some other changes were introduced:

- » Ordering of the parameters was uniformized for better coherency between commands. For example, system always comes before signal and signal always comes before svID.
- » The naming convention also uses the suffix [...]ForSV and [...]ForEachSV where applicable.

Here are some examples of changes made to the API.

Satellite Power

```
SetSatellitePower(system, prn, powerOffset, otherSatsFollow) // deprecated
SetPowerForSV(system, svId, powerOffset, otherSatsFollow)
// new command
```

Changes:

- » The prn is replaced with svID
- » The name uses the [...]ForSV suffix convention

Enable Signal

```
EnableSignal(prn, signal, enabled) // deprecated
EnableSignalForSV(signal, svId, enabled) // new command
```

Changes:

- » The prn is replaced with svID
- » The name uses the [...]ForSV suffix convention
- » The parameter signal comes before svID

Change the transmitted PRN

```
SetGpsCodePrn(satPrn, transmittedPrn) // deprecated
SetTransmittedPrnForSV(svId, signalPrnDict) // new command
```

In this case, the changes are more significant. It is now possible to change the PRN per signal. The same GPS satellite could use different PRNs for C/A, L1C, L2C, etc.

Also, this command introduces a new parameter type: the dictionary. It is now possible to use multiple key/value pairs; you can set multiple signals with different PRNs using a single command.

Lastly, the word "GPS" was removed from the command name to generalize the concept to all constellations. Here's an example of the command expressed as a JSON object:

```
{
  "CmdName": "SetTransmittedPrnForSV",
  "CmdUuid": "{3c9af86c-23f7-4c9c-aab1-6ee4718c14b4}",
  "SvId": 7,
  "SignalPrnDict":
  {
    "L1C": 7,
    "L1CA": 8,
    "L2C": 8,
    "L5": 7
  }
}
```

It is no longer possible to identify a satellite using a PRN alone because it can be duplicated. However, if you want to retrieve the SV ID corresponding to a specific PRN, use the following commands:

```
GetPrnOfSVID(signal, svId)
GetPrnForEachSV(signal)
```

The command `GetPrnOfSVID` returns the PRN for a specific signal and satellite, while `GetPrnForEachSV` returns a vector to return the same information for all satellites.

8.5 NMEA Serial Port Logging

8.5.1 Introduction

Skydel can log NMEA data. This data will correspond to the output of a receiver that has tracked the simulation and will follow the v4.10 NMEA standard.

You can choose to output it in a file or in a serial port. This can be useful for testing your post-processing tools, or for connecting Skydel to another device that accepts NMEA data.

This section describes the NMEA Serial Port Logging feature available in the Skydel interface.

8.5.2 Configure the serial port

In the " Preferences" on page 32 menu, you can configure the NMEA logger serial port by clicking on the Edit button.

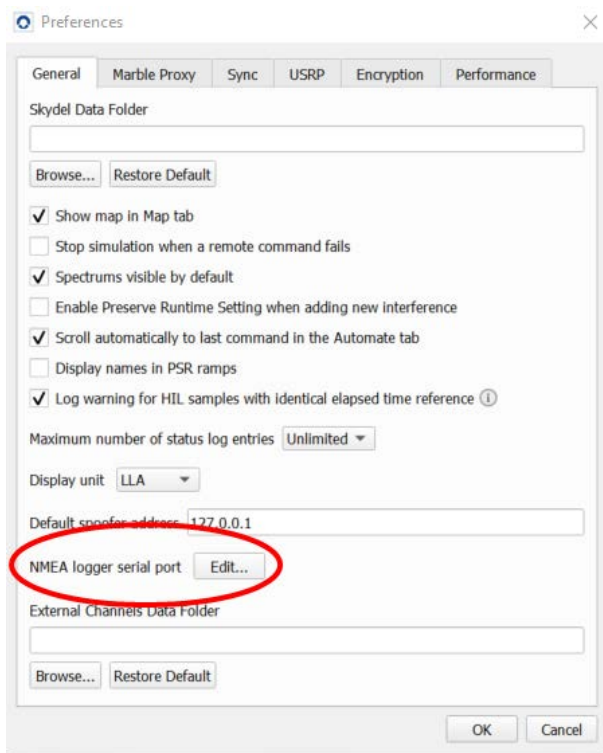

You will also be able to select the baud rate, data bits, parity, stop bits and flow control parameters from the Choose NMEA Logger Serial Port window.

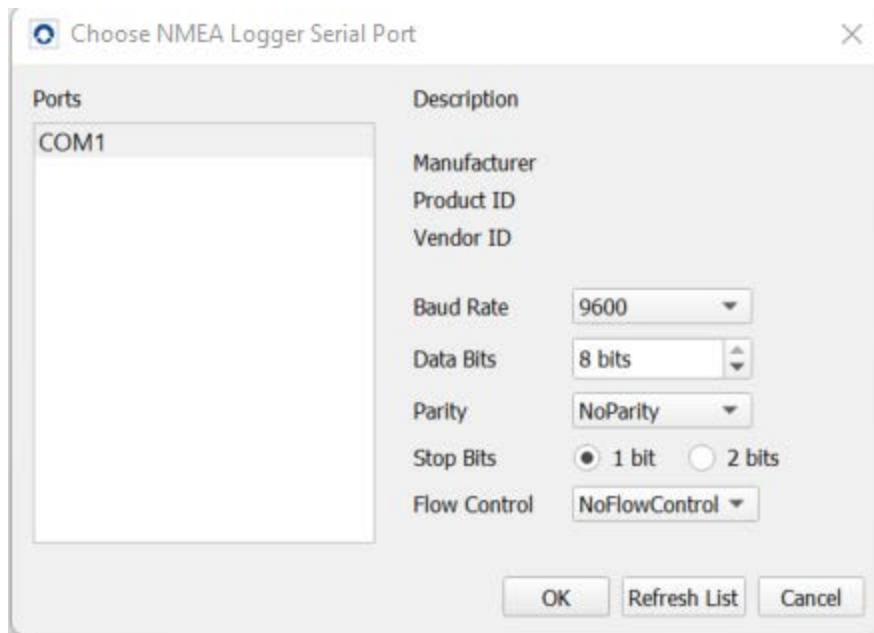

8.5.3 Enabling serial port distribution

You can activate the NMEA Serial Port Logging in the Settings/Global menu from the Skydel interface.

You can then select the timing offset you want to apply between the PPS rising edge and the NMEA message first bit.

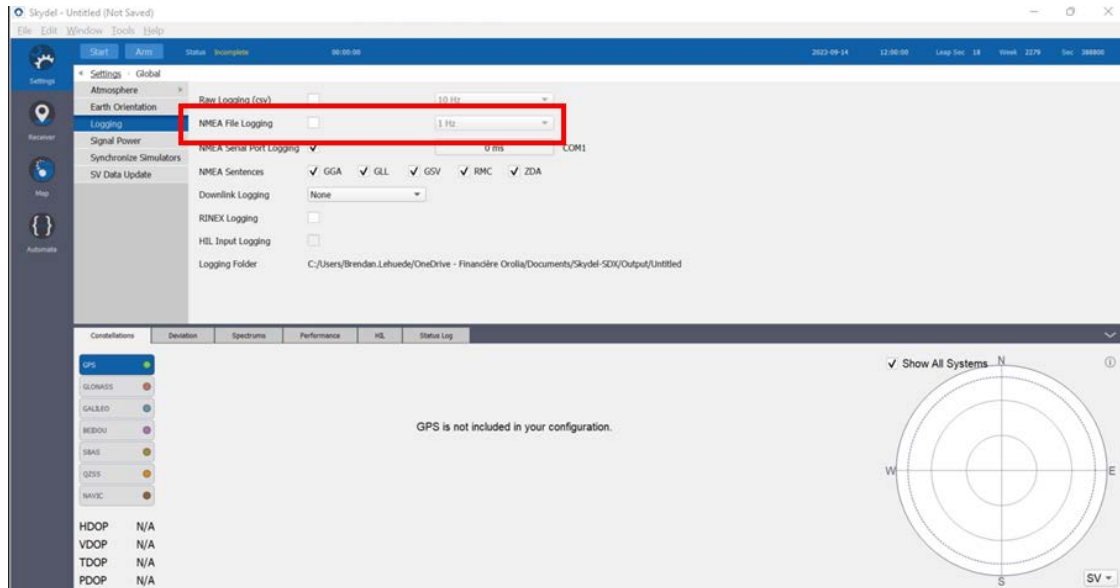

8.5.4 Alignment between PPS and NMEA messages

The first bit rising edge of the NMEA messages will be synchronized with the PPS rising edge if there's no timing offset. The NMEA message content will always correspond to the aligned 1PPS when the timing offset is 0ms. The timing offset allows the user to synchronize the NMEA message arrival with other devices.

Please see the oscilloscope views below.

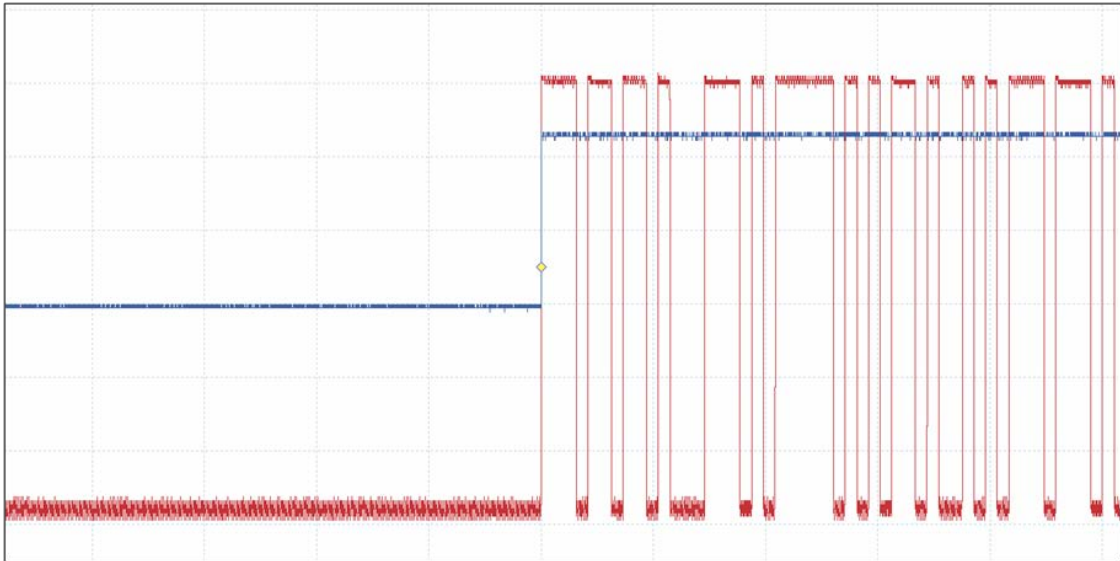

Figure 8-4: Configuration 1: Timing offset=0ms. 1PPS in blue and NMEA messages in red.



Figure 8-5: Configuration 2: Timing offset=20ms. 1PPS in blue and NMEA messages in red.

8.5.5 NMEA message type

The NMEA message types can be enabled/disabled using the NMEA Sentences field. The NMEA message sequence will remain fixed.

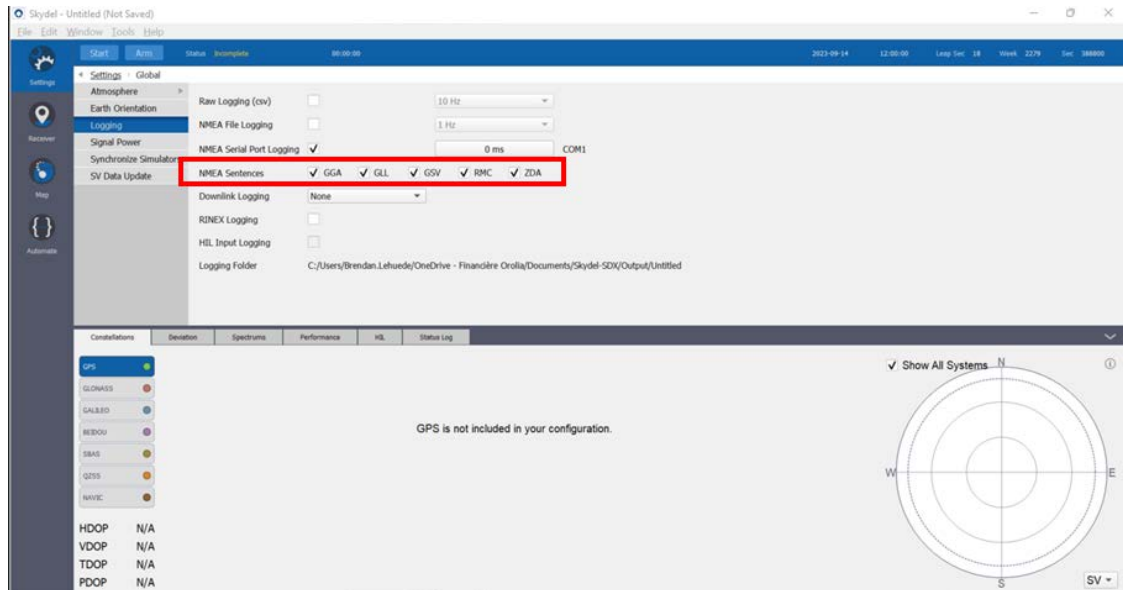

8.6 List of Tables

Table 2-1: Safety symbols used in this document, or on the product 11

8.7 List of Images

Figure 1-1: Propagation of the real GNSS signal from the satellite to the GNSS receiver 5
 Figure 1-2: Propagation of the simulated GNSS signal from GSG-8 Gen2 to the GNSS receiver 5
 Figure 1-3: IQ Signal Generation. For more on IQ file formats, see the "IQ Files" on page 1 appendix. 6
 Figure 3-1: Main Window 18
 Figure 3-2: Constellations Subtab 19

Figure 3-3: Deviation Subtab	20
Figure 3-4: Spectrums Subtab - Showing GNSS signals on RF A and B	20
Figure 3-5: Performance Subtab - Showing a minute of simulation	21
Figure 3-6: Pipeline	22
Figure 3-7: Stable Pipeline	23
Figure 3-8: Pipeline underrun	24
Figure 3-9: Performance Subtab - Showing different scenarios in Last Second graph	25
Figure 3-10: HIL Subtab	26
Figure 3-11: Status Log Subtab	26
Figure 3-12: Dashboard	26
Figure 3-13: Settings Tab	58
Figure 3-14: GPS Constellation	60
Figure 3-15: GLONASS Constellation	60
Figure 3-16: Sky View Information	63
Figure 3-17: Simplified version when a satellite uses only one PRN.	134
Figure 3-18: Detailed version when a satellite uses multiple PRN values.	134
Figure 3-19: Pseudorange Errors (Gauss-Markov function)	138
Figure 3-20: Ephemeris Errors	138
Figure 3-21: Antenna Model submenu	140
Figure 3-22: Antenna Assignment submenu	143
Figure 3-23: Script can run from external PC or on the test equipment itself	211
Figure 3-24: The Documentation tab describes each parameter for the command.	213
Figure 4-1: HIL Setup	228
Figure 4-2: SecureSync Time Reference	229
Figure 4-3: HIL Sequence Diagram	231
Figure 4-4: Performance Subtab - Showing a minute of HIL simulation	236
Figure 4-5: Trajectory Extrapolation	237
Figure 4-6: Trajectory Discontinuity Mitigation	238
Figure 4-7: Trajectory Smooth Transition	238
Figure 4-8: Non-Deterministic Trajectory	239
Figure 4-9: HIL Subtab	240
Figure 4-10: HIL Graph Zoom	240
Figure 4-11: Optimal Pattern	247
Figure 4-12: Large Tjoin Value	248
Figure 4-13: Large Tjoin Value (Zoom)	248
Figure 4-14: Small Tjoin Value	248
Figure 4-15: Small Tjoin Value (Zoom)	248
Figure 4-16: Jitter	249
Figure 4-17: Jitter (Zoom)	249
Figure 4-18: Jitter Visible on the Performance Graph	250

Figure 4-19: Lost Sample	251
Figure 4-20: Lost Sample (Zoom)	251
Figure 4-21: Late Sample (Snap!)	252
Figure 4-22: Falling Behind / Catching Up	252
Figure 4-23: Optimal Pattern	255
Figure 4-24: Optimal Pattern (Zoom)	255
Figure 4-25: Large Time Offset Pattern	256
Figure 4-26: Small Time Offset Pattern	257
Figure 4-27: Jitter	257
Figure 4-28: Lost Sample	258
Figure 5-1: Skydel and Skydel Client	260
Figure 5-2: Main/Worker and Skydel Client	261
Figure 5-3: Skydel state machine	262
Figure 5-4: Normal start	263
Figure 5-5: Arm & Start	264
Figure 5-6: Start HIL	264
Figure 5-7: Main/Worker sync with PPS rising edge	266
Figure 5-8: Main/Worker sync with user-defined PPS rising edge	267
Figure 5-9: HIL and Main/Worker sync with user-defined PPS rising edge ..	268
Figure 5-10: Sync with timing receiver	269
Figure 8-1: Skydel showing SV ID instead of PRN	302
Figure 8-2: Skydel showing SV ID instead of PRN for QZSS	303
Figure 8-3: Skydel showing SV ID with multiple PRNs	304
Figure 8-4: Configuration 1: Timing offset=0ms. 1PPS in blue and NMEA messages in red.	310
Figure 8-5: Configuration 2: Timing offset=20ms. 1PPS in blue and NMEA messages in red.	310

BLANK PAGE.

INDEX

A

Advanced Jammer [186](#)
Antenna [138, 181](#)
 Offset [182](#)
API [211](#)
Assignment [143](#)
Atmosphere [79](#)
Attenuate [5](#)
attenuator [5](#)
Automate [210](#)
Automate tab [211](#)
Automatic [Message](#)
 Sequence [156](#)

B

Basic Interference [222](#)
BEIDOU [149](#)
Body [164](#)

C

CDM-7 [45](#)
Circular [167](#)
Clock & Group Delay [125](#)
CNAV [115](#)
CNAV-2 [119](#)
Command Design Pattern [210](#)

Command Line Options [27](#)
Computer Time [76](#)
Configuration, new [49](#)
Configurations [48](#)
Constellation [105](#)
Constellations [19](#)
Custom Time [75](#)

D

Data Sets [108](#)
Dektec [37, 42](#)
Deviation [19](#)
Downlink [90](#)
Duration [78](#)
Dynamic Mode [103](#)
Dynamic Transmitter [187](#)

E

Earth Orientation Parameters [82](#)
Earth-Orbiting Spacecraft [177](#)
Elevation Mask [185](#)
Engine Latency [45](#)
Ephemeris [96, 108](#)
Ephemeris Errors [138](#)
Errors [81, 136](#)
Extrapolation Mode [103](#)

F

Fixed trajectory 167

G

GALILEO 145

Gaussian Noise 66

General settings 106

Geostationary 123

Getting Started 50

Global 79

Global settings 79

GLONASS 143

GNSS Simulation 4

GPS 106

GPS Timing Receiver Tim 77

H

Hardware- in- the- Loop (HIL) 176,
228

Health 126

HIL 25, 228

Code Example 232

Graph 239

Input 97

latency 235

Sending Positions in
Advance 253

Sequence Diagram 230

Time Reference 229

I

Interface 17

Interference 186, 222

IQ 6

Data 6

Data Files 72

File Jammer 199

Signal Generation 6

J

Jammer, IQ File 199

Jammer, multi-band 200

Jamming 222

L

Launching 16

Leap second 77, 144

License

Update 31

Licensing 29

LNAV 113

Logging 85

M

Map 208

Message Modification 111

Message Sequence 120

Models 139

Monitoring 162

Multi-band Jammer 200

Multipath 126

N

NavIC 152
NMEA 90, 306
NMEA Serial Port Logging 306
Nominal 79
NTP Server 39
NTP Server Time 76

O

Octoclock-G 38
Optimizations 44
Optimizing Performance 70
Orbital Errors 138
Orbits 121
OSNMA 146
Output 63
Output settings 63
Overview 57

P

Performance 20, 44
Perturbations 124
Plug 274
Power Levels 5
Preferences 32
Preferences, General 33
Propagation Model 83
Proxy 35
Pseudorange Errors 137
Pseudorange Offset 136
PULSAR XL 163

Python API example 104

Q

QZSS 150
QZSS L6 152

R

Radio Selectio 64
Raw 86
Raw Logging 86
Receiver 205
Reference Power Level 69
References 298
RINEX 96
Rinex Observation Logger 278

S

Safety
 instructions
 symbols 11
 Symbols 11
Satellite Data Update 102
SBAS 153
scenarios 48
Sequencer 183
Service Message 161
Settings 57, 105, 164, 186
 Constellations 105
 Global 79
 Interference 186
 Map 208
 Output 63

Receiver 205
Start Time 73
Vehicle 164
Signal Enable/Disable 130
Signal Level 97
Signal Power 97
Signal Selection 65
Signal type
 Frequency band 87, 199
Simplified Transmitter 187
simulated vehicle 164
Simulation, first 50
Simulator State 26
Six Degrees of Freedom 165
Skydel-SDX Folder 295
SNMP 224
Software Configuration, Linux
 Ubuntu 290
Software Installation 289
software-only 289
Spectrum 20
Spoofing instance 203
Start Time 73
Status Lo 26
Streaming Buffer 44
Synchronization 36
Synchronize Simulators 100
Synchronize, GPS Timing 101
Synchronize, main/worker 100

T

Technical support 298
Terrain Obscuration 105, 280

Timing 260
Timing, introduction 260
Timing, Main/Worker Setup 265
Timing, Receiver Setup 268
Timing, Single Skydel Setup 262
Timing, Trigger 269
Track Playback 168
Trajectory 192, 237
Transmitted PRN 133
Transmitter, dynamic 187
Transmitter, simplified 187
Trigger 269
Truth instance 204

U

USRP 40

V

Vehicle 164
Vehicle Simulation 175
vehicle trajectory 164
version 21.3 301

W

Welcome Screen 16