

WR-ZEN

SERIES

User Manual



WR-ZEN TP-FL



WR-ZEN TP-FL 4PPS



WR-ZEN TP-FL 8PPS

Revision: v3.4
Date: 14-October-2022



© 2022 Orolia. All rights reserved.

The information in this document has been carefully reviewed and is believed to be accurate and up-to-date. Orolia assumes no responsibility for any errors or omissions that may be contained in this document, and makes no commitment to keep current the information in this manual, or to notify any person or organization of updates. This User Manual is subject to change without notice. For the most current version of this documentation, please see our web site at orolia.com.

Orolia reserves the right to make changes to the product described in this document at any time and without notice. Any software that may be provided with the product described in this document is furnished under a license agreement or nondisclosure agreement. The software may be used or copied only in accordance with the terms of those agreements.

End-user customers of Orolia products may, without the need for a written license from Orolia, reproduce and modify any Orolia product documentation accompanying such products, for distribution within their organization in order to use the products.

Orolia authorized partners, systems integrators, government contractors, and other similarly-situated third-party installers may, without the need for a written license from Orolia, reproduce Orolia product documentation (including media type changes) and create derivative works thereof in the form of compilations, for distribution to their end-users.

Except as described above, no part of this publication may be reproduced, stored in a retrieval system, or transmitted in any form or any means electronic or mechanical, including photocopying and recording for any purpose without the written permission of Orolia.

Other products and companies referred to herein are trademarks or registered trademarks of their respective companies or mark holders.

Orolia USA, Inc.

- 45 Becker Road, Suite A, West Henrietta, NY 14586 USA
- 3, Avenue du Canada, 91974 Les Ulis, France

The industry-leading Seven Solutions products you depend on are now brought to you by Orolia, the global leader in Resilient Positioning, Navigation and Timing Solutions.

Do you have questions or comments regarding this User Manual?

➔ E-mail: techpubs@orolia.com

Blank page.

CONTENTS

CHAPTER 1

Introduction	1
1.1 About this Document	2
1.2 About WR-ZEN	2
1.3 About WRZ-OS	3
1.4 About White Rabbit / High-Accuracy Technology	4

CHAPTER 2

Product Description	7
2.1 Front panel	8
2.2 Rear panel	15
2.3 Monitoring LEDs	16
2.3.1 General Status	16
2.3.2 SFP Ports	17
2.4 Product Specifications	18
2.4.1 WR-ZEN TP	18
2.4.2 WR-ZEN TP-FL	19
2.4.3 WR-ZEN TP-32BNC	20
2.5 Safety Notes	21
2.6 Rack Installation	23
2.7 Regulatory Compliance	24
2.7.1 EMC	24
2.7.2 Safety	24
2.7.3 RoHS	24

CHAPTER 3

Device Connectivity	25
3.1 Default Configuration	26
3.2 Connecting to the Device	26
3.2.1 Necessary Items for Connectivity	26

3.2.2 Logging from the UART	26
3.2.3 Logging from SSH	27
3.2.4 Connecting on Linux (Ubuntu 18.04 LTS)	28
3.2.4.1 Logging from UART	28
3.2.4.2 Logging from SSH	29
3.2.5 Connecting on Windows	30
3.2.5.1 Logging from UART	30
3.2.5.2 Logging from SSH	31
3.2.6 Logging from web	31

CHAPTER 4

GUI & CGI Tools	35
4.1 Parameters API Introduction	36
4.1.1 Table representation	37
4.2 The Web GUI	38
4.2.1 Network configuration from web	40
4.3 CLI Configuration	42
4.3.1 Network configuration from CLI	43
4.4 CLI Monitoring	45
4.4.1 Listing parameters	45
4.4.1.1 Readback a specific parameter	46
4.4.2 Applying changes online	47
4.4.3 Other functionalities	47
4.5 Other CLI tools	48

CHAPTER 5

Timing	49
5.1 Multi-sources & Resiliency	50
5.1.1 Timing Sources	50
5.1.2 FOCA: The Failover Clock Algorithm	50
5.1.3 Virtual Clock Overview	53
5.2 General Timing Management	54
5.2.1 Presets	55
5.2.1.1 WRSlave @ wr0 (BC) [default]	55
5.2.1.2 External Atomic Clock (GM)	55

5.2.1.3 External GNSS Receiver (GM)	56
5.2.1.4 WR Slave @ wr0 → wr1 (BC)	56
5.2.1.5 WR Slave @ wr0 / PTP Fan-Out	57
5.2.1.6 WR Slave @ wr0>wr1 / PTP Fan-Out	57
5.2.1.7 Manual Free-Running	57
5.2.1.8 Custom	58
5.2.2 Reference topology	61
5.2.3 Timing source info	62
5.3 White Rabbit	64
5.3.1 Configuration	64
5.3.2 Info/Overview	64
5.3.2.1 Active servo	64
5.3.2.2 Port Instance	65
5.4 IEEE 1588-2008 (PTPv2)	68
5.4.1 License	69
5.4.1.1 PTP license management	70
5.4.2 Configuration	71
5.4.2.1 Configuration of PTP Profiles	73
5.4.3 Info/Overview	75
5.5 External Reference (GM)	79
5.5.1 Configuration	79
5.5.2 Info/Overview	80
5.6 NTP	81
5.6.1 Configuration	81
5.6.1.1 NTP Provider	81
5.6.1.2 NTP Timing Source Configuration	82
5.6.2 Info/Overview	83
5.6.3 Stratum Levels	83
5.7 Holdover	84
5.7.1 Configuration	85
5.7.2 Info/Overview	86
5.8 Miscellaneous	87
5.8.1 Update Leap Seconds File	87

CHAPTER 6

Security & Authentication	89
6.1 Upload SSH keys	90
6.2 HTTPS	90
6.3 TACACS+	93
6.3.1 Verification of TACACS+ installation	93
6.3.2 TACACS+ Client configuration	93
6.4 RADIUS	95
6.4.1 RADIUS configuration files	95
6.4.2 Verification of RADIUS installation	96
6.4.3 RADIUS client configuration	96
6.5 Firewall	98
6.5.1 Example to only allow a specific IP for management	98

CHAPTER 7

Monitoring & Logging	101
7.1 Syslog	102
7.1.1 Session logs	102
7.1.2 Permanent logs	103
7.1.3 Remote logs	103
7.1.4 Logging tools	103
7.1.5 Configuration	104
7.2 SNMP	105
7.2.1 Configuration	106
7.2.1.1 General configuration	108
7.2.1.2 Specific SNMP v1/v2 configuration	109
7.2.1.3 Specific SNMPv3 configuration	110
7.2.2 SNMP Traps	111
7.2.2.1 Trap objects	112
7.2.2.2 Trap notifications	113
7.2.2.3 Trap configuration	114
7.2.2.4 Basic trap receptor NMS configuration	114
7.3 LLDP	115
7.3.1 Standard (IEEE 802.1AB-2005) TLVs	116
7.3.2 Configuration	116

7.3.3 Info/Overview	117
7.4 Healthing	120
7.4.1 Information/Overview	120
7.4.2 Configuration	122
7.5 LCD screen menu	123
7.5.1 Screen Saver	123
7.5.2 Main Screen	124
7.5.3 Main Menu	125
7.6 External monitoring tool	129

CHAPTER 8

Device Maintenance	131
8.1 Licenses	132
8.1.1 List of related Licenses	132
8.1.2 Check Licenses	132
8.1.3 Order Licenses	134
8.1.4 Local Licenses Management	134
8.1.4.1 Map a feature to a device	135
8.1.4.2 Create A New Device	136
8.1.4.3 Load local license file in the device	136
8.1.4.4 Remove local license from device	137
8.1.5 License Server	138
8.2 Firmware Update	138
8.2.1 Hardware version and firmware	139
8.2.2 Using Web interface	139
8.2.3 Using SSH/SCP	141
8.3 Recovery Mode	142
8.3.1 Manual recovery mode	143
8.3.1.1 Using reset button	143
8.3.1.2 From SerialUART	143
8.4 Factory Config Mode	144
8.5 Failsafe Mode	144

APPENDIX

Appendix	147
-----------------------	------------

9.1 Acronyms	148
9.2 Troubleshooting	149
9.2.1 Frequently answered questions (FAQ)	149
9.2.2 Health general status	150
9.2.3 Virtual State Clock Code Error	151
9.2.4 How to report an error	151
9.2.5 Rsyslog template to improve remote login	151
9.2.6 Warranty	152
9.2.7 Contact	152
9.3 Technical Support	153
9.3.1 Regional Contact	153
9.4 VCS Code	153
9.4.1 Grand Master (GM VCS Code)	154
9.4.2 Boundary Clock (BC VCS Code)	155
9.4.3 Others	158
9.5 Persistent Custom Files	159
9.6 Timing outputs	160
9.7 TACACS+ and RADIUS server configuration	162
9.7.1 TACACS+ server installation and configuration	162
9.7.2 RADIUS server installation and configuration	163
9.8 List of supported SFPs	164
9.9 List of Tables	164
9.10 List of Images	165
9.11 Document Revision History	167

INDEX

CHAPTER 1

Introduction

The following topics are included in this Chapter:

1.1 About this Document	2
1.2 About WR-ZEN	2
1.3 About WRZ-OS	3
1.4 About White Rabbit / High-Accuracy Technology	4

1.1 About this Document

This document is the main user guide of the WR-ZEN Series. It describes the essential information about the WR-ZEN hardware, its features, and configuration options.

It is designed to allow users who have their first contact with the device to easily connect it to a management network and distribute precise timing (PTP or White Rabbit (WR), for example) through optical interfaces. It also provides advanced tips for expert users and/or details how to match the security policies defined at your company.

The set of official manuals also includes the **WRZ-OS API guide** for complete documentation about your WR-ZEN.

1.2 About WR-ZEN

The White Rabbit ZEN Time Providers (referred to as WR-ZEN in this document) are high performance timing nodes family whose design is based on the Xilinx Serie-7 FPGAs that combines an Artix-FPGA with a Dual-Core ARM.

It is composed of the following products:

- » WR-ZEN TP
- » WR-ZEN TP-32BNC
- » WR-ZEN TP-FL

They are the versatile standalone nodes that provide WR features (i.e., sub-nanosecond time synchronization in a network with thousands of nodes) controlled by a user-friendly Linux OS which runs on a dual ARM processor.

The WR-ZEN easily distributes time and frequency to other equipment by implementing standard timing protocols such as PTP, NTP and IRIG-B. The WR-ZEN combines ultra-stable clocks with low jitter and temperature compensated clock resources to enhance its synchronization accuracy. In addition, it allows integrating FMC cards.

Its robustness to failure is one of its key features thanks to redundant dual power supply and a fanless design.

It is also worth mentioning its ability to support daisy chain configurations in which each WR-ZEN device synchronizes with another WR-ZEN belonging to a higher order in the hierarchy level. At the same time, it provides synchronization to a lower level.

A typical intra-datacenter network topology is shown in the figure below, where the WR-ZEN is working as the grandmaster and is the key element for distributing the timing through WR to each cabinet of the datacenter. Different end nodes are included in the diagram to illustrate the interoperability with different interfaces.

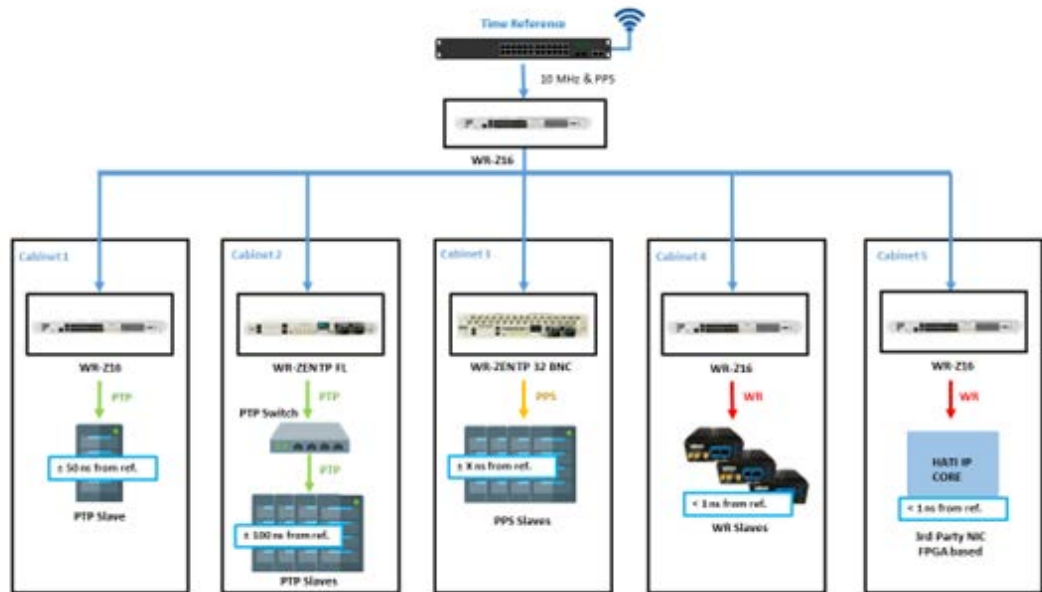

Figure 1-1: Intra-datacenter WR network topology

There are different options and licenses which enable specific functionalities of the WR-ZEN. These options are described in the table below:

Table 1-1: Options and Licenses available in WR-ZEN

Option /License	Description
Holdover option	An optional holdover oscillator can be included to maintain high accuracy (<1.5us/24h) even when all timing references are down.
PTP license	The device is shipped with the default profile of PTPv2/IEEE1588-2008. Other configuration including specific profiles support requires activation license.
HATI license	Enable the WR-ZEN to provide high accuracy synchronization to the HATI FPGA IP CORE. This license might be available per port or within a pack.

1.3 About WRZ-OS

The WR-ZEN is part of a full ecosystem of products which maintain sub-nanosecond accuracy synchronization from an external time reference to the end nodes of the timing network, where different timing interfaces are provided to inter-operate with third-party equipment.

The **WR-Z16** devices and the **WR-ZEN family** (WR-ZEN TP, WR-ZEN TP-FL, WR-ZEN TP-32BNC) run on the same platform (**WRZ-OS**) sharing the same features, timing stack and set of tools.

All the devices running the WRZ-OS provide multiple interoperability options that include 1PPS/10 MHz signals, standard PTP, and NTP. They support SNMP v2/v3, rsyslog, and have an integrated web GUI for intuitive management and enhanced command line tools for advanced users. The following list contains the different form factors offered within the WR-ZEN family and a brief description of their main characteristics:

- » WR-ZEN TP-FL: A fundamental, cost-effective 1U form factor version of the WR-ZEN TP. It has a front dual power supply. It includes 1PPS/10 MHz SMA outputs and standard PTP interoperability on its management interfaces. It can include a 4 x 1PPS expansion on demand.
- » WR-ZEN TP: Standard 1U form factor version of the time provider. It accepts multiple fans and it has a rear dual power supply. It includes multiple 1PPS/10 MHz on the SMA or DB9 outputs, standard PTP interoperability on its management interfaces, IRIG-B, NMEA and ToD.
- » WR-ZEN TP-32BNC: Expanded 2U form factor version of the WR-ZEN TP. It has a front dual power supply. It includes 1PPS/10 MHz SMA outputs and standard PTP interoperability on its management interfaces. The main characteristic is that it includes 32 BNC ports configured to work as 16 x 1PPS and 16 x 10 MHz outputs. A configuration with 32 x 1PPS is possible with an optional PPS expansion license.



Figure 1-2: WR-ZEN TP-FL (left), WR-ZEN TP (middle), WR-ZEN TP-32BNC (right)

1.4 About White Rabbit / High-Accuracy Technology

One of the key-features of the WR-ZEN family is that it fully supports the White Rabbit (WR) protocol, an extension of the IEEE 1588 (PTP), to achieve ultra-accurate sub-nanosecond synchronization in Ethernet-based networks. Since the publication of the new IEEE 1588-2019 standard, White Rabbit is also known as “PTP High Accuracy” (HA) profile, and has the following characteristics:

- » Time Precision: WR provides a common clock for physical layer in the entire network, allowing synchronization at sub-nanosecond level with picoseconds precision. In other words, the timing budget consumed by WR is almost insignificant.

- » Scalability: WR networks are designed to be highly scalable supporting thousands of nodes and long-distance links within the range of metro area deployments. Its performance is not affected by traffic as with other PTP profiles.
- » Cost effective solution: WR avoids expensive costs related to calibration and complex deployments with high requirements of maintenance, allowing plug-and-play links in Local Area Networks (LANs).
- » Integration: WR is based on existing protocols and standards (such as PTP and Ethernet) so it is very easy to integrate into your existing network infrastructure.

BLANK PAGE.

CHAPTER 2

Product Description

The Chapter presents an overview of the WR-ZEN Series, its capabilities, main technical features and specifications.

The following topics are included in this Chapter:

2.1 Front panel	8
2.2 Rear panel	15
2.3 Monitoring LEDs	16
2.4 Product Specifications	18
2.5 Safety Notes	21
2.6 Rack Installation	23
2.7 Regulatory Compliance	24

2.1 Front panel

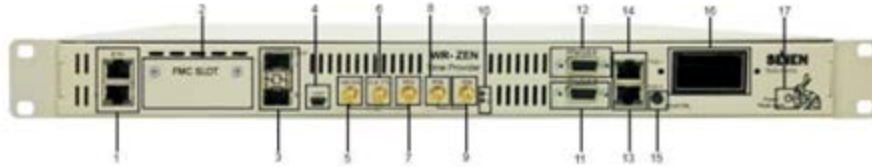



Figure 2-1: WR-ZEN TP front panel

Table 2-1: Front Panel of the WR-ZEN TP Legend

#	Name	Information	Ref.
#1	2x Management Ethernet (RJ45)	<ul style="list-style-type: none"> ● 10/100/1000 ethernet network interface (eth0 & eth1) 	"WR-ZEN TP" on page 18
#2	FMC expansion port	<ul style="list-style-type: none"> ● Slot placed to allow the use of FMC cards 	"WR-ZEN TP" on page 18
#3	2x SFP Fiber Ports	<ul style="list-style-type: none"> ● 1GBps SFP compatible 	
#4	1x ARM Mini-USB (B) UART	<ul style="list-style-type: none"> ● Serial UART Mini-USB (B) 	"White Rabbit" on page 64 "IEEE 1588-2008 (PTPv2)" on page 68
Timing output			
#5	10 MHz output	<ul style="list-style-type: none"> ● SMA connector (F) ● Output from PLL ● High level output: 2.5V (with 50 Ω termination) 	"Virtual Clock Overview" on page 53
#6	CLK TTL output	<ul style="list-style-type: none"> ● SMA connector (F) ● High level output: 2.5V +/- 0.2V (with 50 Ω termination) ● By default, it is configured to output 10MHz 	"Virtual Clock Overview" on page 53
#7	PPS output	<ul style="list-style-type: none"> ● SMA connector (F) ● Digital output ● High level output: 2.5V +/- 0.2V (with 50 Ω termination) 	"Virtual Clock Overview" on page 53
Timing input			

#	Name	Information	Ref.
#8	PPS input	<ul style="list-style-type: none"> ● SMA connector (F) ● 50 Ω termination ● TTL input (3.3V) 	"External Reference (GM)" on page 79
#9	10 MHz input	<ul style="list-style-type: none"> ● SMA connector (F) ● 50 Ω termination ● 1 V_{eff} (+/-30%) sine wave 	"External Reference (GM)" on page 79
#10	LED	<ul style="list-style-type: none"> ● Red: error LED ● Green: Status LED 	"General Status" on page 16
#11	DB9 PPx/CLK A	<ul style="list-style-type: none"> ● High level output: 1.7V +/- 0.2V (with 50 Ω termination) 	
#12	DB9 PPx/CLK B	<ul style="list-style-type: none"> ● Selectable 50 Ω termination ● High level output: 3.0V +/- 0.2V (with 50 Ω termination) ● High level output: 3.3V +/- 0.2V (without 50 Ω adaptation) 	
#13	TOD0	<ul style="list-style-type: none"> ● RJ45 RS422 ● Time of Day / NMEA 	
#14	TOD1	<ul style="list-style-type: none"> ● RJ45 RS422 ● Time of Day / NMEA 	
#15	INFO/CTRL Button	<ul style="list-style-type: none"> ● Button used to access to information a control settings 	
#16	LCD Display	<ul style="list-style-type: none"> ● Panel for alert & configuration information 	"LCD screen menu" on page 123
#17	Power/Reset Alarm button 	<ul style="list-style-type: none"> ● Power On/Off the device and perform a factory reset 	"Recovery Mode" on page 142

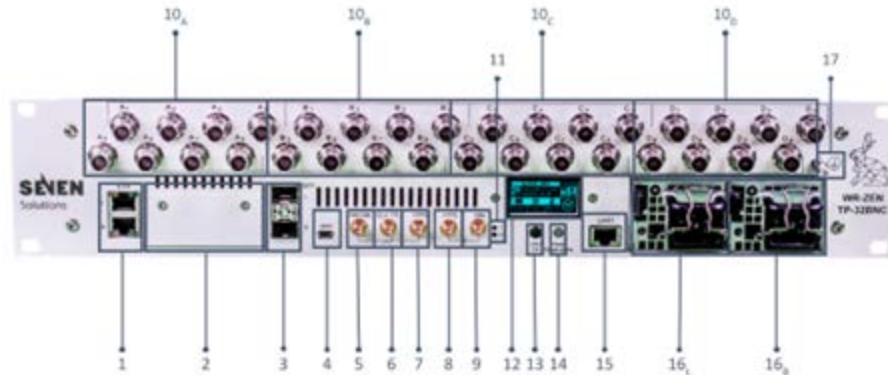







Figure 2-2: WR-ZEN TP 32-BNC front panel

Table 2-2: Front Panel of the WR-ZEN TP 32-BNC Legend

#	Name	Information	Ref.
#1	2x Management Ethernet (RJ45)	● 10/100/1000 ethernet network interface (eth0 & eth1)	"WR-ZEN TP-32BNC" on page 20
#2	FMC expansion port	● Slot placed to allow the use of FMC cards	"WR-ZEN TP-32BNC" on page 20
#3	2x SFP Fiber Ports	● 1Gbps SFP compatible	"White Rabbit" on page 64 "IEEE 1588-2008 (PTPv2)" on page 68
#4	1x ARM Mini-USB (B) UART	● Serial UART Mini-USB (B)	
Timing output			
#5	10 MHz output	<ul style="list-style-type: none"> ● SMA connector (F) ● Output from PLL ● High level output: 2.5V (with 50 Ω termination) 	"Virtual Clock Overview" on page 53
#6	CLK TTL output	<ul style="list-style-type: none"> ● SMA connector (F) ● High level output: 2.5V +/- 0.2V (with 50 Ω termination) ● By default, it is configured to output 10MHz 	"Virtual Clock Overview" on page 53
#7	PPS output	<ul style="list-style-type: none"> ● SMA connector (F) ● Digital output ● High level output: 2.5V +/- 0.2V (with 50 Ω termination) 	"Virtual Clock Overview" on page 53

#	Name	Information	Ref.
Timing input			
#8	PPS input	<ul style="list-style-type: none"> ● SMA connector (F) ● 50 Ω termination ● TTL input (3.3V) 	"External Reference (GM)" on page 79
#9	10 MHz input	<ul style="list-style-type: none"> ● SMA connector (F) ● 50 Ω termination ● 1 Veff (+/-30%) sine wave 	"External Reference (GM)" on page 79
#10 A	8x Configurable PPS/10 MHz	<ul style="list-style-type: none"> ● BNC connector (F) ● Digital output ● High level output: 1.7V +/- 0.2V (with 50Ω termination) 	
#10 B	8x Configurable PPS/10 MHz	<ul style="list-style-type: none"> ● BNC connector (F) ● Digital output ● High level output: 1.7V +/- 0.2V (with 50Ω termination) 	
#10 C	8x Configurable PPS/10 MHz	<ul style="list-style-type: none"> ● BNC connector (F) ● Digital output ● High level output (Selectable 50Ω termination): ● 3V +/-0.2V (with 50Ω termination) ● 3.3V +/- 0.2V (without 50Ω adaptation) 	
#10 D	8x Configurable PPS/10 MHz	<ul style="list-style-type: none"> ● BNC connector (F) ● Digital output ● High level output (Selectable 50Ω termination): ● 3V +/-0.2V (with 50Ω termination) ● 3.3V +/- 0.2V (without 50Ω adaptation) 	
#11	LED	<ul style="list-style-type: none"> ● Red: error LED ● Green: Status LED 	"General Status" on page 16
#12	LCD Display	<ul style="list-style-type: none"> ● Panel for alert & configuration information 	"LCD screen menu" on page 123

#	Name	Information	Ref.
#13	INFO/CTRL Button	● Button used to access to information a control settings	
#14	Power/Reset Alarm button 	● Power On/Off the device and perform a factory reset	"Recovery Mode" on page 142
#15	1x Management UART (RJ45)	Serial UART RS232 on a RJ45 connector with pinout (USB-RJ45/RS232 adaptor not included)	
		Pin #1: Pin #2: Pin #3 Pin #4 ✘ ✘ RXD GND Pin #5: Pin #6: Pin #7: Pin #8: ✘ TXD ✘ ✘	
Power Supply			
#16 L	Power Supply #1	● Swappable & monitorable module: - 100- 240VAC, 50- 60Hz,   (80W Max)	
#16 R	Power Supply #2	● Swappable & monitorable module: - 100- 240VAC, 50- 60Hz,   (80W Max)	
#17	Ground	● Ground connector of the device 	

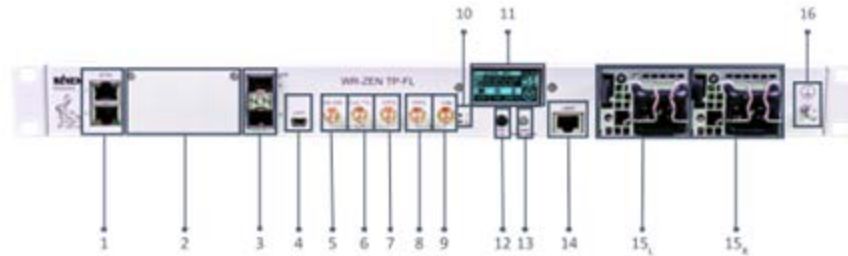







Figure 2-3: WR-ZEN TP-FL front panel

Table 2-3: Front Panel of the WR-ZEN TP-FL Legend

#	Name	Information	Ref.
#1	2x Management Ethernet (RJ45)	● 10/100/1000 ethernet network interface (eth0 & eth1)	"WR-ZEN TP-FL" on page 19
#2	FMC expansion port	● Slot placed to allow the use of FMC cards	"WR-ZEN TP-FL" on page 19
#3	2x SFP Fiber Ports	● 1Gbps SFP compatible	"White Rabbit" on page 64"IEEE 1588-2008 (PTPv2)" on page 68
#4	1x ARM Mini-USB (B) UART	● Serial UART Mini-USB (B)	
Timing output			
#5	10 MHz output	<ul style="list-style-type: none"> ● SMA connector (F) ● Output from PLL ● High level output: 2.5V (with 50 Ω termination) 	"Virtual Clock Overview" on page 53
#6	CLK TTL output	<ul style="list-style-type: none"> ● SMA connector (F) ● High level output: 2.5V +/- 0.2V (with 50 Ω termination) ● By default, it is configured to output 10MHz 	"Virtual Clock Overview" on page 53

#	Name	Information	Ref.																
#7	PPS output	<ul style="list-style-type: none"> ● SMA connector (F) ● Digital output ● High level output: 2.5V +/- 0.2V (with 50 Ω termination) 	"Virtual Clock Overview" on page 53																
Timing input																			
#8	PPS input	<ul style="list-style-type: none"> ● SMA connector (F) ● 50 Ω termination ● TTL input (3.3V) 	"External Reference (GM)" on page 79																
#9	10 MHz input	<ul style="list-style-type: none"> ● SMA connector (F) ● 50 Ω termination ● 1 Veff (+/-30%) sine wave 	"External Reference (GM)" on page 79																
#10	LED	<ul style="list-style-type: none"> ● Red: error LED ● Green: Status LED 	"General Status" on page 16																
#11	LED	<ul style="list-style-type: none"> ● Red: error LED ● Green: Status LED 	"General Status" on page 16																
#12	LCD Display	<ul style="list-style-type: none"> ● Panel for alert & configuration information 	"LCD screen menu" on page 123																
#13	Power/Reset Alarm button 	<ul style="list-style-type: none"> ● Power On/Off the device and perform a factory reset 	"Recovery Mode" on page 142																
#14	1x Management UART (RJ45)	<p>Serial UART RS232 on a RJ45 connector with pinout (USB-RJ45/RS232 adaptor not included)</p> <table border="0"> <tr> <td>Pin #1:</td> <td>Pin #2:</td> <td>Pin #3:</td> <td>Pin #4:</td> </tr> <tr> <td>✘</td> <td>✘</td> <td>RXD</td> <td>GND</td> </tr> <tr> <td>Pin #5:</td> <td>Pin #6:</td> <td>Pin #7:</td> <td>Pin #8:</td> </tr> <tr> <td>✘</td> <td>TXD</td> <td>✘</td> <td>✘</td> </tr> </table>	Pin #1:	Pin #2:	Pin #3:	Pin #4:	✘	✘	RXD	GND	Pin #5:	Pin #6:	Pin #7:	Pin #8:	✘	TXD	✘	✘	
Pin #1:	Pin #2:	Pin #3:	Pin #4:																
✘	✘	RXD	GND																
Pin #5:	Pin #6:	Pin #7:	Pin #8:																
✘	TXD	✘	✘																
Power Supply																			
#15	Power Supply #1	<ul style="list-style-type: none"> ● Swappable & monitorable module: - 100- 240VAC, 50- 60Hz, <div style="text-align: center;">   </div> <p>(80W Max)</p>																	





#	Name	Information	Ref.
#15 R	Power Supply #2	<ul style="list-style-type: none"> ● Swappable & monitorable module: - 100- 240VAC, 50- 60Hz, (80W Max)  	
#16	Ground	<ul style="list-style-type: none"> ● Ground connector of the device 	

2.2 Rear panel



Figure 2-4: WR-ZEN TP rear panel

Table 2-4: Back Panel of the WR-ZEN TP Legend

#	Name	Information	Ref.
Power Supply			
#1	Power Supply #1	<ul style="list-style-type: none"> ● Swappable & monitorable module: -100-240VAC, 50-60Hz, (80W Max)  	
#2	Power Supply #2	<ul style="list-style-type: none"> ● Swappable & monitorable module: -100-240VAC, 50-60Hz, (80W Max)  	
Plug-and-Play Modules			
#3	Plug-and-play module slot #J1	For swappable modules	
#4	Plug-and-play module slot #J2	For swappable modules	

#	Name	Information	Ref.
#5	Plug-and-play module slot #J3	For swappable modules - By default, we provide the WR-ZEN-TP with one FAN on slot #J3	
#6	Plug-and-play module slot #J4	For swappable modules	
#7	Ground	● Ground connector of the device 	

2.3 Monitoring LEDs

The status of the WR-ZEN device can be quickly verified using the 3 visible LEDs in the front-panel. The tables below detail the behavior of each LED depending on the status of the WR-ZEN.

The blinking behavior of the front panel LEDs is represented by the “Visual” column in the following tables using a sequence of three consecutive instants.

2.3.1 General Status

This LED is mainly used to inform the state of the system itself (Daemons loaded, Fans, power-supply, Temperature, CPU load, Available space, etc.).

This led is also used to identify the various stages and modes of the booting procedure.

Table 2-5: Status LED behavior

Visual	Behavior	Description
1 ● ● ● 0 ● ● ●	Steady Green	Device system state is OK
1 ● ● ● 0 ● ● ●	Steady Red	Device system state is CRITICAL: user might login to verify the source of error. The device might reboot itself if the error is persistent.
1 ● ● ● 0 ● ● ●	Steady Red & Green	Device system state is WARNING
During booting procedure		
1 ● ● ● 0 ● ● ●	1x Blinking Green	Bootloader initialization OK
1 ● ● ● 0 ● ● ●	[1-15]x Blinking Red & Green	Reset button is held during the booting procedure: - If released: entering recovery mode - If hold > 15s: entering reset factory mode
1 ● ● ● 0 ● ● ●	Steady Red	Device is booting in recovery mode

Visual	Behavior	Description
1 ●●● 0 ●●●	Steady Red & Green	Device is booting in reset factory mode
1 ●●● 0 ●●●	2x Blinking Green	Booting in normal mode
1 ●●● 0 ●●●	Idle	Device is loading kernel and transitioning between modes
1 ●●● 0 ●●●	3x Blinking Green	FPGA initialization OK
1 ●●● 0 ●●●	Steady Red & Green	The hald daemon has been loaded and it is waiting till all daemons are properly loaded
1 ●●● 0 ●●●	Nx Blinking Red & Green	Device is loading in failsafe mode and for each module skipped during initialization the device blinks in orange

2.3.2 SFP Ports

The network ports of the device are arranged in a dual stack SFP cage. The following table represents only the two first ports but can be extrapolated to the other ones. The LEDs of these SFP ports are slightly different to standard usage as it does not differentiate TX/RX but utilizes the arrows to indicate the upper/lower port and their corresponding states:

Table 2-6: Ports LED behavior

Visual	ID	Behavior	Description	
	0	wr0	wr0 corresponds to upper SFP in the stack	
	B	▲	Link down	When link is down led B is disabled
		▲	Link up	When link is up the led B stays in green
	D	▲	Activity	Blinks in orange each time a packet is received on this port
	1	wr1	wr1 corresponds to lower SFP in the stack	
	A	▼	Activity	Blinks in orange each time a packet is received on this port
	C	▼	Link down	When link is down led C is disabled
▼		Link up	When link is up the led C stays in green	

2.4 Product Specifications

2.4.1 WR-ZEN TP

System On-Chip

- » **SoC:** Xilinx Zynq series
- » **CPU:** Dual ARM® Cortex™-A9 MP@ 866 MHz
- » **Memory:**
 - » 512 MB DDR3 (32-bit bus)
 - » 256 Mbits Quad-SPI Flash
 - » 16GB SD Card

Physical Dimension

- » **Dimension:** 431 mm x 44 mm x 300 mm / (1 Rack Unit)
- » **Color:** White (Metallic)

Environmental Conditions

- » **Temperature:** -10°C ~ +50°C
- » **Humidity:** 0% ~ 90% RH

Front Panel

- » **Ethernet:** 2x 100/1000 Base-T RJ45 (Management, PTP, NTP)
- » **FMC:** 1x Low-Pin count FMC slot (LPC)
 - » Using HPC-FMC footprint to support extra GTP channel/clock on board
- » **SFP Ports:** 2x 1GbE
- » **Clocks I/O:** 5x SMA connectors (3.3V @50Ω):
 - » 10MHz SIN OUT ref.clock (PLL)
 - » CLK TTL OUT
 - » PPS OUT (LVTTTL)
 - » PPS IN (LVTTTL)
 - » 10MHz IN (TTL/CMOS/ECL/clipped sine)
- » **Timing:** Common outputs to provide Timing
 - » 2xRJ45, ToD (NMEA) RS485
 - » 2xDB9, 4x configurable* xPPS/CLK

- » *xPPS/CLK outputs are divided in two groups of 4 customized PPS/CLK (1, 10, 1k-10M)Hz similar to the SMA Aux Clk.
- » **LCD:** Information panel for alert & network
- » **Debug:** USB Mini-B (ARM-UART)

Back-panel

- » **Fan** 2 x (1-4) Swappable fan modules

2.4.2 WR-ZEN TP-FL

System On-Chip

- » **SoC:** Xilinx Zynq series
- » **CPU:** Dual ARM® Cortex™-A9 MP@ 866 MHz
- » **Memory:**
 - » 512 MB DDR3 (32-bit bus)
 - » 256 Mbits Quad-SPI Flash
 - » 16GB SD Card

Physical Dimension

- » **Dimension:** 444 mm x 43 mm x 221 mm / (1 Rack Unit)
- » **Color:** White (Metallic)

Environmental Conditions

- » **Temperature:** -10°C ~ +50°C
- » **Humidity:** 0% ~ 90% RH

Front Panel

- » **Ethernet:** 2x 100/1000 Base-T RJ45 (Management, PTP, NTP)
- » **SFP Ports:** 2x 1GbE
- » **Clocks I/O:** 5x SMA connectors (3.3V @50Ω):
 - » 10MHz SIN OUT ref.clock (PLL)
 - » CLK OUT (LVTTTL)
 - » PPS OUT (LVTTTL)
 - » PPS IN (LVTTTL)
 - » 10MHz IN (TTL/CMOS/ECL/clipped sine)
- » **LCD:** Information panel for alert & network

- » **Expansion:** 4x SMA coaxial connectors (3.3V/50Ω):
 - » PPS OUT (LVTTL)

2.4.3 WR-ZEN TP-32BNC

System On-Chip

- » **SoC:** Xilinx Zynq series
- » **CPU:** Dual ARM@ A9 MP@ 866 MHz
- » **Memory:**
 - » 512 MB DDR3 (32-bit bus)
 - » 256 Mbits Quad-SPI Flash
 - » 16GB SD Card

Physical Dimension

- » **Dimension:** 428 mm x 88 mm x 220 mm / (2 Rack Units)
- » **Color:** White (Metallic)

Environmental Conditions

- » **Temperature:** -10°C ~ +50°C
- » **Humidity:** 0% ~ 90% RH







Front Panel

- » **Ethernet:** 2x 100/1000 Base-T RJ45 (Management, PTP, NTP)
- » **SFP Ports:** 2x 1GbE
- » **Clocks I/O:** 5x SMA connectors (3.3V @50Ω):
 - » 10MHz SIN OUT ref.clock (PLL)
 - » CLK OUT (LVTTL)
 - » PPS OUT/IRIG-B (LVTTL)
 - » PPS IN (LVTTL)
 - » 10MHz IN (TTL/CMOS/ECL/clipped sine)
- » **Fanout:** 32 BNC configurable outputs divided in 2 groups (1.7V/50Ω):
 - » A&B: 10MHz (xPPS under license) with 50Ω termination
 - » C&D: xPPS, IRIG-B with selectable 50Ω termination
- » **LCD:** Information panel for alert & network
- » **Debug:** USB Mini-B (ARM-UART)

2.5 Safety Notes

Safety: Symbols Used

Table 2-7: Safety symbols used in this document, or on the product

Symbol	Signal word	Definition
	DANGER!	Potentially dangerous situation which may lead to personal injury or death! Follow the instructions closely.
	CAUTION!	Caution, risk of electric shock.
	CAUTION!	Potential equipment damage or destruction! Follow the instructions closely.
	NOTE	Tips and other useful or important information.
	MULTIPLE POWER SOURCES	This equipment may contain more than one power source: Disconnect all power supply cords before removing the cover to avoid electric shock.
	EQUIPOTENTIALITY	Identify the terminal(s) which, when connected together, bring the various parts of the device to the same potential, not necessarily being the earth (ground) potential.
	STANDBY	Identify the switch by means of which part of the equipment is switched on in order to bring it into the stand-by condition, and to identify the control to shift to or to indicate the state of low power consumption.

SAFETY: Before You Begin Installation



DANGER!

Do not block the air vents which are located on the front panel of the device, the internal temperature might increase and damage the equipment.

**DANGER!**

The FAN modules must only be replaced by a skilled person. Once reinstated, its screw must be tightened up using a flat-blade screwdriver with at least 0.8Nm to avoid any manual manipulation.

**DANGER!**

Replacement of a power supply module has been intended only for occasional use by a skilled person. Hazardous energy inside the device might be accessible when a module is extracted. Do not make any kind of contact with any part inside the unit.

**DANGER!**

Installation of this product must be located in restricted access areas where only skilled persons are authorized. This product is not to be installed by the user/operator. Installation of the equipment must comply with local and national electrical codes.

**DANGER!**

This equipment must be earth grounded. Never defeat the ground connector or operate the equipment in the absence of a suitably installed earth ground connection. Contact the appropriate electrical inspection authority or an electrician if you are uncertain that suitable grounding is available.



Caution: To increase the lifetime of your device it is recommended to use it in a controlled temperature environment and limit to the ambient condition:

Temperature: -10°C ~ +50°C; Humidity; 0% ~ 90% RH



Note: The use of dust covers is recommended for the unused SFP/SFP+ slots.

2.6 Rack Installation

The device has been designed to be mounted in a standard 19-inch (48.3 cm) equipment rack and thus respect the following physical dimensions:

- » Width: 431 mm
- » Height: 44mm (1x Rack Unit)
- » Depth: 300 mm



Caution:

The following guidelines are provided to prevent bodily-injury when mounting or servicing this unit in a rack:

- This unit should be mounted at the bottom of the rack if it is the only unit in the rack.
- When mounting this unit in a partially filled rack, load the rack from the bottom to the top with the heaviest component at the bottom of the rack.
- If the equipment rack is on wheels, ensure that the brakes are engaged and that the rack is stabilized.



Note:

Accessories: The screws needed to properly mount the device to the rack are not shipped with the equipment, nor the system ground kit. The device already mounts the L-brackets and is provided with a power cord C13 (European).



Note:

Airflow consideration: There are no standards for airflow in rack system but the device should be configured accordingly to the emplacement of hot and cold aisles. The default airflow of the device is from front-panel (cold) to back-panel (hot).

To properly mount the device to a rack cabinet:

1. Place the device on the floor or on a sturdy table near the rack.
2. Use a tape measure to verify the interior dimensions of the rack.
3. Carefully lift the device and position the rear of the device between the equipment rack mounting posts and slide the device into the rack until the L brackets on the sides of the device are flush with the equipment rack front posts.

4. Align the mounting holes in the L bracket with the mounting holes in the equipment rack posts.
5. Secure the device using four 3/4-inch screws through the elongated holes in the L bracket and into the threaded holes in the mounting post (or the clip-nuts or cage-nuts).

2.7 Regulatory Compliance

2.7.1 EMC

- » EN55032:2015
- » AC:2016
- » EN55035:2017
- » EN61000-3-2:2014
- » EN61000-3-3:2013
- » FCC: 47 CFR Part 15B (10–1–15 Edition)
- » ICES-003 Issue 6

2.7.2 Safety

- » IEC 62368-1:2014
- » AC:2015
- » A11:2017

2.7.3 RoHS

- » 2011/65/UE
- » 2015/863/UE

CHAPTER 3

Device Connectivity

This chapter includes instruction to aid in device connectivity.

The following topics are included in this Chapter:

3.1 Default Configuration	26
3.2 Connecting to the Device	26

3.1 Default Configuration

The device is factory configured with the following default settings:

Table 3-1: Default Factory Settings

Port/ Service	Default Value
eth0	Waits for DHCP offer
eth1	192.168.77.100
Timing Preset	Slave on WRO (BC) WR master on all other ports
HTTPS	Disabled
SSH/web credentials	user: root password: root

The device credentials can be configured as needed. Learn more in "[Security & Authentication](#)" on page 89.

3.2 Connecting to the Device

There are two ways to connect to the WR-ZEN device using the terminal:

- » Via UART
- » Via SSH

This section will first introduce the general concepts on how to log to the device and then it will provide the specific steps, depending on the user OS.

3.2.1 Necessary Items for Connectivity

These are the required cables and adapters:

- » RJ-45 Cat5/6/7 Ethernet cable.
- » RJ45-RS232(m) and RS232(f)-USB cable.

3.2.2 Logging from the UART

In order to connect to the WR-ZEN device, it is required to connect the RJ45-RS232(m) and RS232(f)-USB cable to the RJ45 management port at the front panel.

Multiple software can be used to read from the UART in the computer depending on the operating system used for that purpose (e.g. Minicom, Picocom or Putty). Learn more in the below sections.

The following table summarizes the settings required to connect to the serial port (UART) of the device:

Table 3-2: UART Settings

Setting	Value
Baud Rate	115200 bps
Data	8 bits
Parity	None
Stop bits	1 bit
Flow Control	none

3.2.3 Logging from SSH



Caution:

Remote authentication servers (TACACS+/Radius): If there is any remote authentication server configured and it is responding, the local credentials of the user root will not be used. Only if the remote server is not working or is unreachable, will the local credentials be available again. This can render the device accessible only by UART.

There are three main ways to connect to the WR-ZEN device from SSH:

1. To use the default static IP on eth1:
 - » Connect the RJ-45 Ethernet cable to the eth1 interface.
 - » Connect the host interface to the same LAN and configure its IP address to be within the same netmask.
 - » Access the device by typing in the host terminal:
`ssh root@192.168.77.100`
2. To use a DHCP server on eth0:
 - » Connect the RJ-45 Ethernet cable to the eth0 interface and to a LAN network with a DHCP server.
 - » Connect the host interface (your PC) to the same LAN, to obtain another IP address.
 - » Retrieve the IP address assigned to the device using UART or by scanning the local network.



Note: DHCP IP address: The assigned IP should persist between device reboots, as it will ask for the same address after every bootup.

3. To use a manual network configuration from UART:
 - » Connect the device using UART (see ["Logging from the UART" on page 26](#)).
 - » Follow the steps described in network configuration from CLI (see ["Network configuration from CLI" on page 43](#)).
 - » Reboot the device.
 - » Connect eth0 or eth1 (according to the user network configuration).

3.2.4 Connecting on Linux (Ubuntu 18.04 LTS)

3.2.4.1 Logging from UART

To connect to the device terminal via UART, use the RJ45-RS232(m) and RS232(f) USB to connect to the UART management port, in the front panel of the WR-ZEN as shown in the ["Front panel" on page 8](#) Hardware section.

The recommended software to manage UART connections on Linux is picocom, which you should be able to install just by running with super user privileges:

```
sudo apt install picocom
```

Once installed, the command to establish the connection with picocom is similar to:

```
picocom -b 115200 /dev/ttyUSB<X>
```

where ttyUSB<x> corresponds to the instance of the USB-UART driver. In most of the case, it will be ttyUSB0 (e.g., only one USB-UART cable connected to the PC) and the expected output is as follows

```
$ sudo picocom -b 115200 /dev/ttyUSB0
Calling 'sudo /usr/bin/picocom -b 115200 /dev/ttyUSB0 -b 115200'
Exiting Ctrl+A, then Ctrl+X
picocom v2.2
port is : /dev/ttyUSB0
lowcontrol : none
baudrate is : 115200
parity is : none
databits are : 8
```

```
stopbits are : 1
escape is : C-a
local echo is : no
noinit is : no
noreset is : no
nolock is : no
send_cmd is : sz -vv
receive_cmd is : rz -vv -E
imap is :
omap is :
emap is : crcrlf,delbs,
Type [C-a] [C-h] to see available commands
Terminal ready
```



Note: USB device discovery

The target device's name may vary depending on the names of other devices. The `dmesg | grep tty` command can be used to discover which name has been set to the connected device. This is an example output:

```
[4.616728] cp210x 3-6.1.2:1.0: cp210x converter detected
[4.620195] usb 3-6.1.2: cp210x converter now attached to
ttyUSB0
```

In the case of the above output, `/dev/ttyUSB0` would be the device's name.

As a recommended alternative, *Putty* for Linux works properly. Programs like *minicom* or *screen* can be used, although they are not fully recommended for color compatibility issues.

3.2.4.2 Logging from SSH

Ubuntu distributions (and many others) have already installed all ssh-related tools necessary to connect to the device. The user does not need to perform any specific steps and can directly follow instructions detailed in "[Logging from SSH](#)" on page 27.

3.2.5 Connecting on Windows

3.2.5.1 Logging from UART

The connection to the UART in the WR-ZEN Series can be made by using Putty, the SSH and Telnet client for Windows, as it supports serial connections too.

When having connected the RJ45-RS232-USB cable to the Windows PC, a new serial port identified by COM<number> at the Device Manager, as can be checked in the figure below.

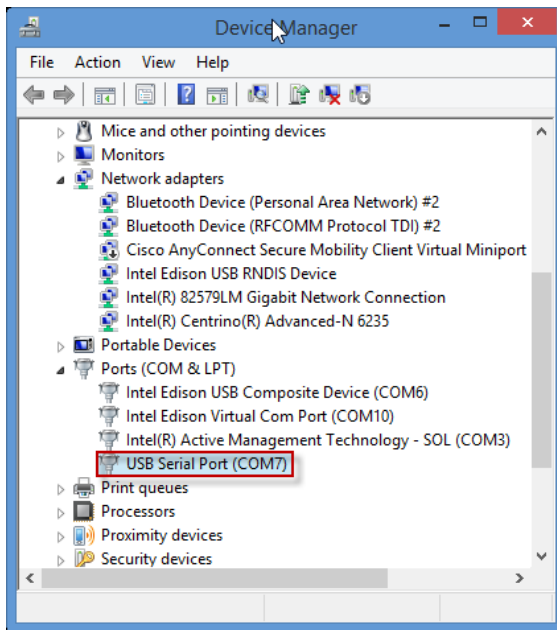

Figure 3-1: Device manager. New serial port detected.

Afterwards, the connection can be made through Putty. The connection type should be marked as Serial at <1>. The serial port name COM<number> should be placed at <2>, and the port speed (115200 Bd) at <3> (see below).

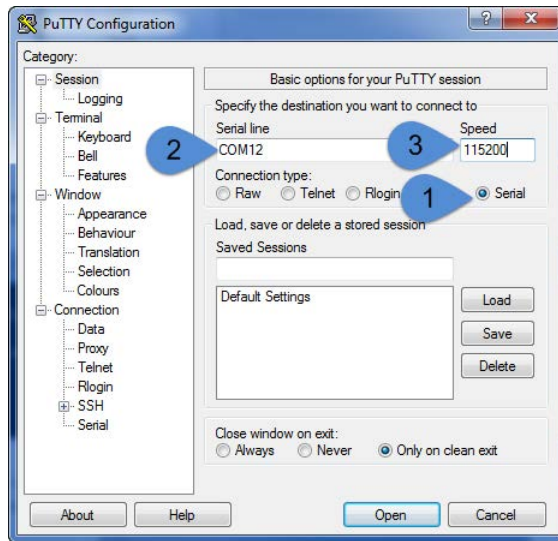

Figure 3-2: Putty configuration for serial port connection.

3.2.5.2 Logging from SSH

It is also possible to connect to the device via SSH with Putty

The process to connect to the UART using Windows (XP, Vista, 7, 8, 10) is explained below:

1. Download and install the Putty Tool.
2. Verify that the Connection type corresponds to SSH .
3. Finally, write root@<IP> under the Host Name (or IP address) field, and click on Open.

Compatibility with wrz_config

In order to make Putty compatible with the wrz_config color scheme and avoid strangecharacters, it is recommended to try the following configuration:

1. Change remote character set to ISO-8859-1.
2. Uncheck “Override with UTF-8 if locale says so”.
3. Select “Use Unicode line drawing code points” (this is the default).

3.2.6 Logging from web

Once the device is set with an IP address, it can be accessed by typing http://<device_ip> in the browser address bar. By default, https is disabled but if it has been enabled, the address bar should be replaced by https://<device_ip>.

Once connected the WR-ZEN web Dashboard will be shown as in the figure below.

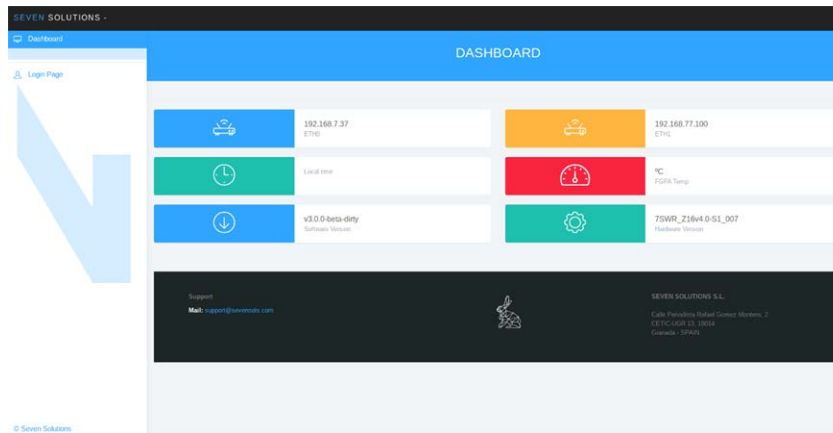

Figure 3-3: Dashboard of the web interface.

To see all the information of the device, the user must login by clicking on Login Page, and provide the corresponding password for the root user (see ["Default Configuration" on page 26](#)).

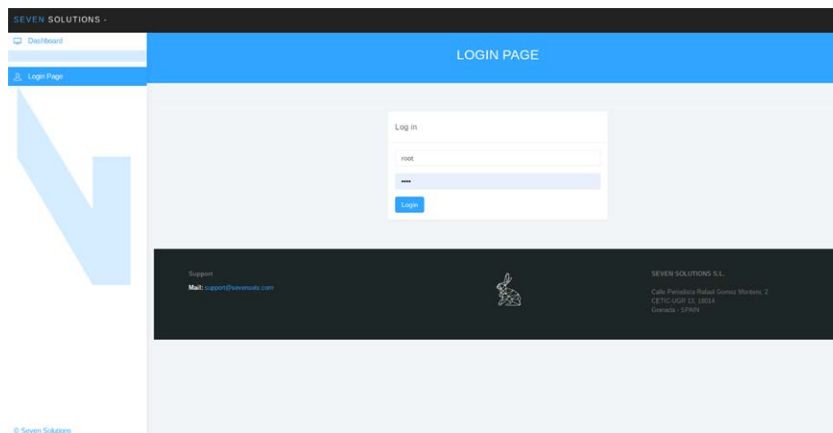

Figure 3-4: Login page of the web interface

Having logged in, all sections from the web interface will be shown, as in the figure below. Further instructions on the available features and how to use them in the WR-ZEN's web interface are detailed in the ["GUI & CGI Tools" on page 35](#) section.

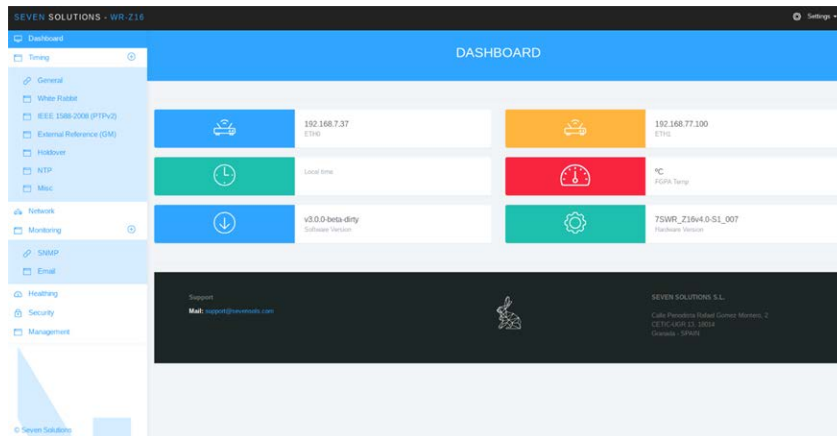

Figure 3-5: All sections on the web interface

BLANK PAGE.

GUI & CGI Tools

Depending on preference, a user can use the web GUI or the CLI tools to perform a standalone management of the device.

This section will briefly explain the main interactions for both methods and will also provide a detailed example of the configuration of the network interfaces.

The following topics are included in this Chapter:

4.1 Parameters API Introduction	36
4.2 The Web GUI	38
4.3 CLI Configuration	42
4.4 CLI Monitoring	45
4.5 Other CLI tools	48

4.1 Parameters API Introduction

Although the interaction using CLI & GUI differs, both approaches rely on the same mechanism handled by the “Generic Parameters Access (GPA)” core library.

In other words, most of the services running in the WRZ-OS can be configured & monitored through common operations using the attributes of parameters. The definition of all attributes that a parameter must handle is given below:

- » **OID**: a unique identifier that should be used that refers to a specific parameter. This OID is composed by three sub-indexes <M>.<D>.<P> corresponding to
 - » <M>: ID of the module.
 - » <D>: ID of the directory/path containing the parameter.
 - » <P>: ID of the parameter inside a specific module directory.
- » **Module**: The name of the corresponding module.
- » **Directory**: The directory attached to the parameter.
- » **Name**: The name of the parameter (Names in the GUI and CLI can slightly differ but their OID are always the same).
- » **Type**: The type of value stored by the parameters.
 - » String: Datatype to represent text.
 - » Enum/Bool: Fixed list of String-Integer associations.
 - » Integer: Integer number with different binary representations (u8, i8, u16, i16, u32, i32, u64, i64).
 - » Decimal: Floating point number (f32 or f64).
 - » Array: Vector of binary types handled like a separated string.
- » **Unit**: Corresponding unit of the parameter including scale (i.e., s, ms, us, ns, ps).
- » **Description**: Description of the parameter.
- » **Access**: How the user can interact with a parameter.
 - » Read: can read the value.
 - » Write: can directly apply (online) the value.
 - » Load: can save the value (it will be applied at next restart).
 - » Disabled: Currently disabled, writing will not apply anything and the value read value might be invalid.
- » **Visibility**: Expert parameters are by default hidden unless toggling the expert mode. Then, the disabled parameters are meaningless and thus temporary hidden to improve legibility.
- » **Status**: Current status of a parameter.

- » Warning: The current value within a given situation corresponds to a warning alert.
- » Critical: The current value within a given situation corresponds to a critical alert.
- » Out-of-Sync: The current value could not be synchronized and is outdated.
- » Unlicensed: This parameter is invalid/unusable without the proper license.
- » Unknown: The whole module that handles the parameter is down.
- » **Events:** Some relevant parameters are associated to events when they change their value (Tracked) or when their value enters an alert range (Warning, Critical) or a smart alert.

Note:

The list of all modules and corresponding parameters together with the value of their attributes can be found in the WRZ-OS API guide.

4.1.1 Table representation

For each specific feature explained through the user-guide, the following table format will be employed to describe the corresponding parameters along with their relevant attributes.

An example is given for the network interface where the same directory has been separated into two tables to follow the same structure as the web GUI panels. The following table corresponds to the parameters related to the configuration of the network interface.

Table 4-1: Configuration parameters of the network interface.

OID	Name	Value Type	Description
1.xxx0.x	/net/<iface>/xxx		Directory related to the <iface> name where OIDs follow the given pattern: wr0 → 201x, wr1 → 211x, ..., wr15 → 361x & eth0 → 680x, eth1 → 690x.
0.xxx0.7	DHCP	<Bool>	Enable/Disable the DHCP IPv4 discovery.
0.xxx0.3	IPv4 Address	<Array> [4 x u8]	IPv4 address of <iface> (format: [0-255].[0-255].[0-255].[0-255]).
0.xxx0.4	IPv4 Net-mask	<Array> [4 x u8]	Subnet mask of <iface> (format: [0-255].[0-255].[0-255].[0-255]).
0.xxx0.5	IPv4 Gate-way	<Array> [4 x u8]	Default gateway for <iface> (format: [0-255].[0-255].[0-255].[0-255]).

The next table corresponds to the parameters that provide information (read-only) about the corresponding interface:

Table 4-2: Information related to the network interface

OID	Name	Value Type	Description
1.xxx0.x	/net/<iface>/xxx		Directory related to the <iface> name where OIDs follow the given pattern: wr0 → 201x, wr1 → 211x, ..., wr15 → 351x & eth0 → 680x, eth1 → 690x.
0.xxx0.1	Status	<Enum> 0. Link Down 1. Link Up 2. Not Found	Status of the interface.
0.xxx0.2	Ethernet Address	<Array> [6 x u8]	MAC address of the corresponding interface with upper case hexadecimal format (e.g., 64:FB:81:20:84:06).
0.xxx0.8	Speed	<String>	Auto-negotiated speed of <iface>.
0.xxx0.9	Tx Packets	<Integer> (u32)	Transmitted packets on <iface>.
0.xxx0.10	Rx Packets	<Integer> (u32)	Received packets on <iface>.
0.xxx0.11	Tx Bytes	<Integer> (u32)	Transmitted bytes on <iface>.
0.xxx0.12	Rx Bytes	<Integer> (u32)	Received bytes on <iface>.
0.xxx0.13	Tx Errors	<Integer> (u32)	Transmission errors on <iface>.
0.xxx0.14	Rx Errors	<Integer> (u32)	Reception errors on <iface>.

4.2 The Web GUI

The web GUI is a user-friendly interface that allows you to monitor and manage the device through a web browser.

After navigating to the device, a dashboard tab will be shown that resumes the main information of the device as the IP addresses for the management ports, the current time and FPGA temperature, and the software and hardware versions.

	192.168.7.36 ETH0		192.168.77.100 ETH1
	2020-06-15 16:01:47 (UTC) Local time		80 °C FPGA Temp
	v3.0.0-S15-127-g63485b85 Software Version		7SWR_Z16v4.0-S1_006 Hardware Version

Figure 4-1: Dashboard in web interface

The device requires the user to log in to enable further navigation. Once this step is performed, the web GUI is divided in three main parts. On the left column, a navigation menu is displayed showing all the different tabs available in the device.

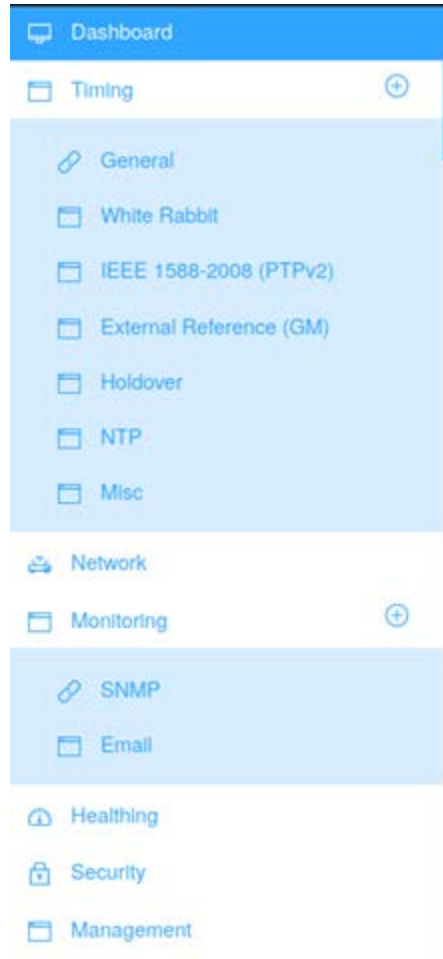

Figure 4-2: Settings menu in web interface

After clicking in each of these tabs, the user is redirected to the page that will show all the available parameters for monitoring or management. It is noteworthy that some of these tabs contain sub-tabs that organize the information depending on the application, the interface or the nature of the parameter (read or write).

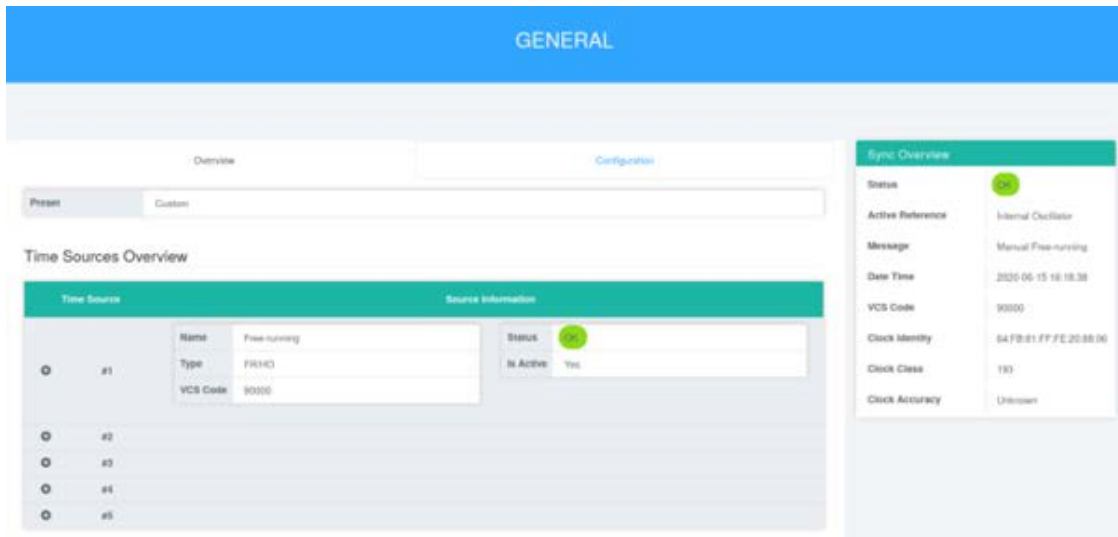
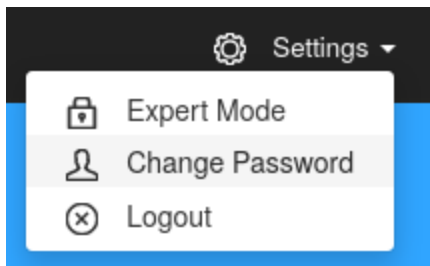

Figure 4-3: Time sources configuration in web interface

Finally, a settings menu on the upper right corner is shown. This menu allows to change the password, enable the expert mode that includes additional parameters and log out from the device:



The web session will automatically terminate after 15 minutes of inactivity. This setting can be disabled or configured via the Expert mode in the Security section.

4.2.1 Network configuration from web

To illustrate how the user should interact with the web interface, an example of the configuration of a static IP for eth0 network interface follows.

First, select the Network section from the left column, then select the tab ETH0 to configure the corresponding interface (ETH0 is the default selection when entering the network configuration).

Then in the CONFIG panel, the user must disable the DHCP option by clicking No in the drop-down list box. If the DHCP is left enabled (Yes), the IPv4 fields will be blocked as read-only, and the displayed values will be retrieved from DHCP responses.

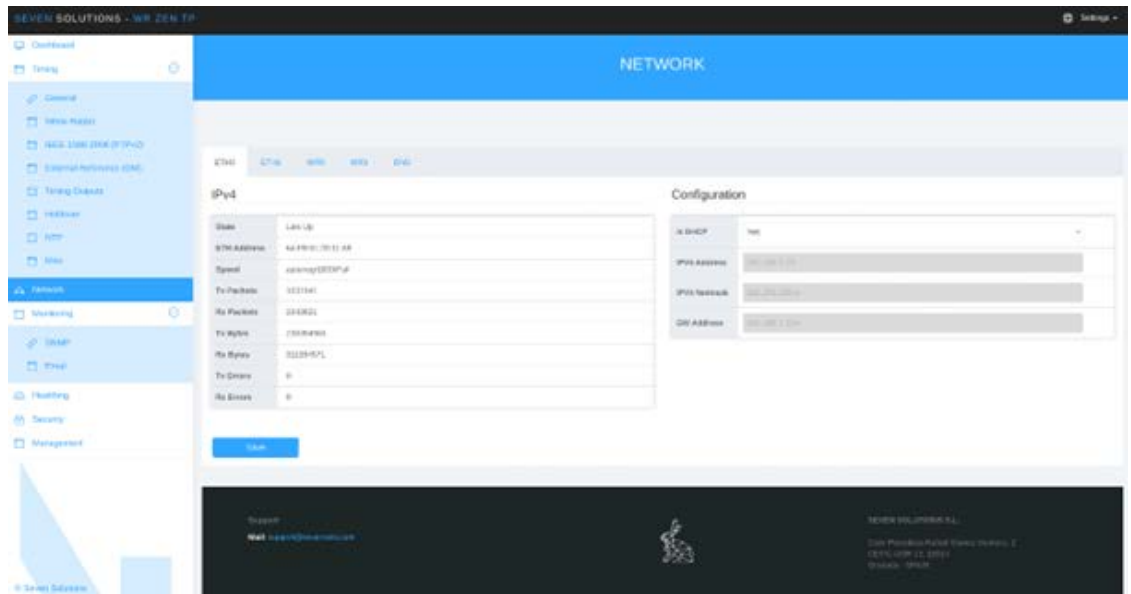

Figure 4-4: Network interface panel in web GUI

Once DHCP is disabled (see below), the user will be able to edit the static IP settings to fit its network configuration.



Figure 4-5: Configuration of static IP using web interface

Finally, the user can save the changes by clicking on Save button. After this action, a warning message will appear (shown in the following image), mentioning that the performed changes will only have effect after the next reboot. This is because the parameters related to network configuration have Load access instead of Write & Load access and thus cannot be directly applied. The user can then directly execute a reboot (clicking on Reboot button) or continue to perform other configurations before rebooting.



Figure 4-6: Warning message to reboot the device so a saved change can take effect

**Note:**

DNS Resolution: The last tab of network configuration entitled DNS can be used to add a custom DNS server needed to resolve IP address. This is useful in case an URL is used instead of an IP when configuring the server for a device (e.g., NTP, Auth, etc.).

4.3 CLI Configuration

If the user prefers to configure the device from the command line, execute the `wrz_config` command.

The `wrz_config` tool provides an interactive menu directly from the command line with a structure similar to the web GUI. The main menus are the following:

- » Timing: All timing-related configuration of the device (see ["Timing" on page 49](#) for more information).
- » Network: Network configuration of the management & timings interfaces (["Network configuration from CLI" on the facing page](#)).
- » Healthing: Power Supplies & Fans related configuration (["Healthing " on page 120](#)).
- » Security: Configuration related to the security of the device (["Security & Authentication" on page 89](#)).
- » Management: Logging & Monitoring (["Monitoring & Logging" on page 101](#)) configuration and aspects related to the maintenance of the device (["Device Maintenance" on page 131](#)).

```
.config - wrzTP Family Configuration

wrzTP Family Configuration
Arrow keys navigate the menu. <Enter> selects submenus ---> (or empty
submenus ----). Highlighted letters are hotkeys. Pressing <Y>
includes, <N> excludes, <M> modularizes features. Press <Esc><Esc> to
exit, <?> for Help, </> for Search. Legend: [*] built-in [ ]

Timing --->
Network --->
Healthing --->
Security --->
Management --->
[*] Show Expert Parameters

<Select> < Exit > < Help > < Save > < Load >
```

Figure 4-7: Main wrz_config interface. Modules to modify

The user can then navigate between the different menus and sub-menus using arrow keys and the <Select> and <Exit> actions.

To get more information about a specific parameter such as its description or its corresponding OID the user can press the <Help> action.

When exiting the wrz_config tool, the user will be asked if he wants to save the changes in the configuration or not.



Note:

Expert parameters: To ease the navigation during configuration some expert parameters are by default hidden. In the main, menu the user can toggle a configuration flag to make visible these expert parameters.



Note:

Changes applied at reboot: It is important to highlight that the changes performed through the wrz_config tool will only be applied at next reboot. Indeed, each init.d services will load their corresponding values from /root/.config file during startup.



Caution:

Avoid manual editing of .config file: In order to avoid errors such as duplicated entries, it is not recommended to manually edit the /root/.config. This might have been suggested for some specific configurations of the previous version (WRZ-OS v2.x) but this practice is now discouraged.

4.3.1 Network configuration from CLI

To illustrate the usage of wrz_config tool, the configuration of the network interface is detailed as a step-by-step procedure. The behavior can then be emulated in other menus in the configuration tool.

To set the IP address for the eth0 management interface:

1. The first step is to execute the wrz_config command from a terminal.
2. Then, the Network section must be selected from the main menu:

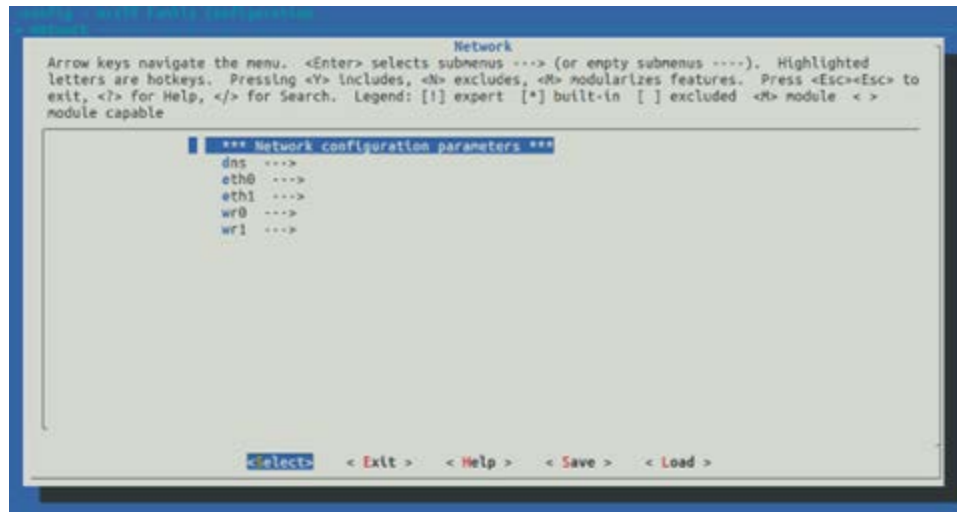

3. Then the corresponding network interface (eth0) to be modified must be selected:.

Figure 4-8: wrz_config interface. Network interfaces to change

4. If the static IPv4 settings must be loaded, disable DHCP

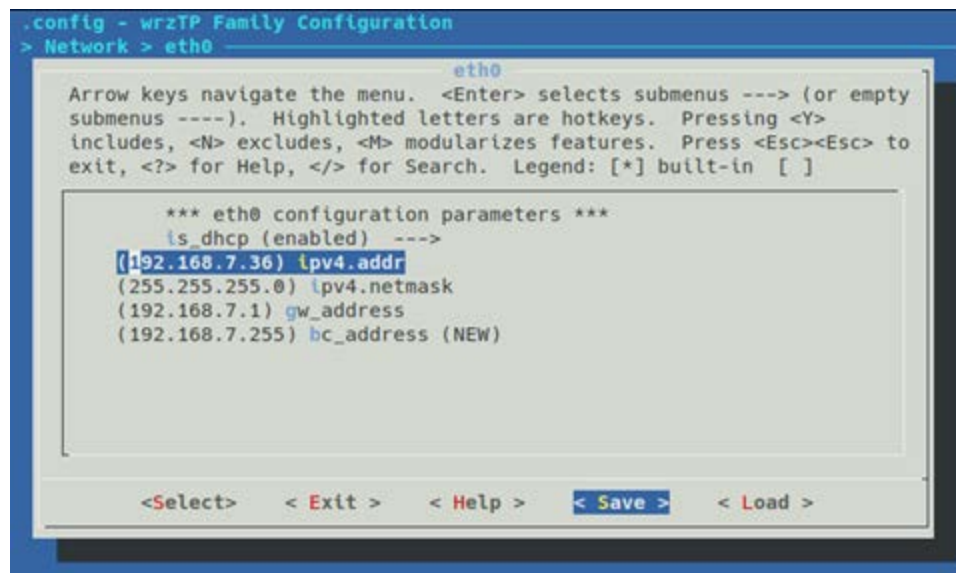

Figure 4-9: wrz_config interface. Interface parameters to change

5. Do not forget to <Save> the changes once the configuration is done. The following message will prompt. To load this configuration at next reboot the default filename (.config) must be used.

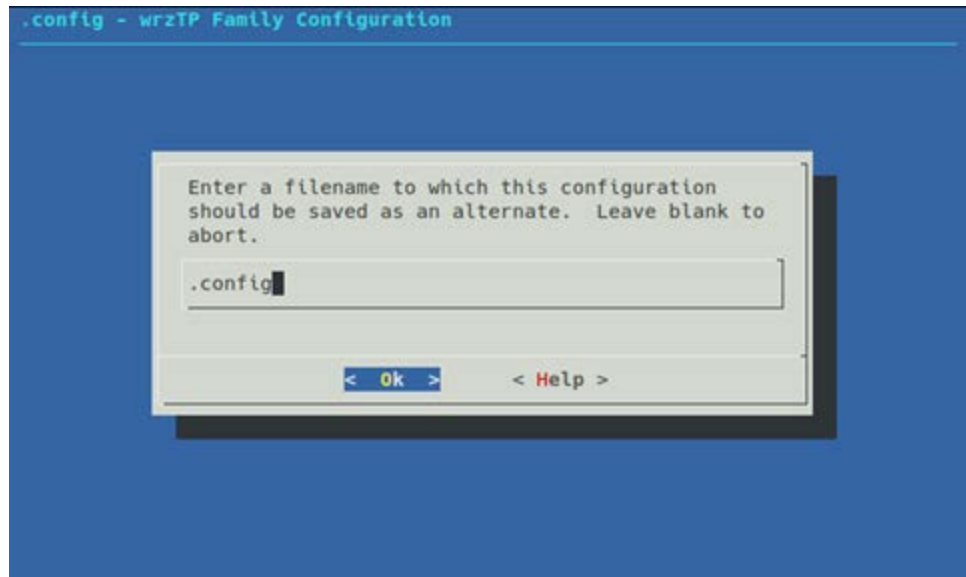

Figure 4-10: wrz_config interface. File in which to save the new applied configuration

6. Select Exit or press <Esc> to return to the command line.



Note:

Verify network configuration after reboot: Network configuration changes are only applied at startup. Thus, it is recommended to reboot the device to verify that the IP settings has been properly updated using the typical ifconfig <ifname> command or through gpa_ctrl tool.

4.4 CLI Monitoring

The gpa_ctrl command tool can be used to monitor the current value and state of all the parameters in the WRZ-OS.

4.4.1 Listing parameters

If the user directly executes gpa_ctrl without any arguments, it will list all the parameters of the WRZ-OS. Then, by specifying some arguments and options the user can slightly modify its usage.

```
gpa_ctrl [OPTIONS] [<module_name> [<path> [<write_val>]]
```

The figure below illustrates the usage of gpa_ctrl to monitor all parameters corresponding to the power supplies by executing the command: gpa_ctrl hald pws/

```

root@sup-tpf1-461:~# gpa_ctrl hald pws
-----|
C 0.9110.1 pws/pwsl/status      : NOT DETECTED
0.9110.2 pws/pwsl/temperature   : 0                C
0.9110.3 pws/pwsl/v_in         : 0.00            V
0.9110.4 pws/pwsl/v_out        : 0.00            V
0.9110.5 pws/pwsl/power_in     : 0.00            W
0.9110.6 pws/pwsl/power_out    : 0.00            W
0.9110.7 pws/pwsl/disable_alert : No
0.9120.1 pws/pwsr/status      : OK
0.9120.2 pws/pwsr/temperature   : 38                C
0.9120.3 pws/pwsr/v_in         : 238.50           V
0.9120.4 pws/pwsr/v_out        : -5757.00         V
0.9120.5 pws/pwsr/power_in     : 22.00            W
0.9120.6 pws/pwsr/power_out    : 16.00            W
0.9120.7 pws/pwsr/disable_alert : No

```

Figure 4-11: Example of gpa_ctrl usage to list power supplies parameters.

The list of related parameters displays in 5 columns:

1. The state of the parameters. In this example only the status of the right power supply (0.9110.1) is in a critical state (C).
2. The OID of the parameter.
3. The path of the parameter inside the module.
4. The value of the parameter.
5. The unit of the parameter (if relevant).

The user can also list only the parameters related to the right power supply by executing:

```
gpa_ctrl hald pws/pwsr/
```

4.4.1.1 Readback a specific parameter

It might also be interesting to only readback a specific parameter. To only get the status of the left and right power supplies the user should execute:

```

root@zen- 425:~# gpa_ctrl hald pws/pwsl/status; echo $?
OK
0
root@zen- 425:~# gpa_ctrl hald pws/pwsr/status; echo $?
Warning: C pws/pwsr/status
NOT DETECTED
204

```



Note:

Return code and stdout/stderr: The gpa_ctrl print parameters to stdout/stderr according to their status such that an advanced user can easily filter them. It also returns specific error code depending on the status. For more information please read carefully gpa_ctrl -h.

4.4.2 Applying changes online

If a parameter is writeable, this means that it can be directly applied by using the following syntax:

```
gpa_ctrl <module_name> <param_path> <new_value>
```

For example, to disable the alert for the right power supply the user must execute:

```
gpa_ctrl hald pws/pwsr/disable_alert Yes
```

If the command returns without any errors, this mean that the changes have been properly applied. This can be checked by reading back the output of

```
gpa_ctrl hald pws/pwsr/
```

4.4.3 Other functionalities

To improve legibility, the parameters can be displayed in a tree view by adding the `-t` flag:

```
root@zen-425:~# gpa_ctrl -t hald pws
0          hald      LEGEND: dir writable readable expert
0.9100    pws
0.9110    └─ pws1
0.9110.1  │   └─ status (OK)
0.9110.2  │   └─ temperature (40C)
0.9110.3  │   └─ v_in (235.500000V)
0.9110.4  │   └─ v_out (11.968750V)
0.9110.5  │   └─ power_in (29.000000W)
0.9110.6  │   └─ power_out (23.000000W)
0.9110.7  │   └─ disable_alert (Yes)
0.9120    └─ pwsr
0.9120.1  │   └─ status (NOT DETECTED)
0.9120.2  │   └─ temperature (0C)
0.9120.3  │   └─ v_in (0.000000V)
0.9120.4  │   └─ v_out (0.000000V)
0.9120.5  │   └─ power_in (0.000000W)
```

The user can get more information about the parameters by using the verbose flag `-v`:

```

root@zen-425:~# gpa_ctrl -v hald pws/pwsr
-----
desc: The Hardware Abstraction Layer Daemon (HALD)
      status: Running (0)
      nparams: Warning:0, Critical:0, Out-of-sync:0
-----
0.9120.1 pws/pwsr/status : NOT DETECTED range:[0,65535]
         | "Global Status. 0:ok; otherwise:error."
0.9120.2 pws/pwsr/temperature : 0 C
         | "Temperature of PWS in °C"
0.9120.3 pws/pwsr/v_in : 0.000000 V
         | "Power Supply: Volts IN"
0.9120.4 pws/pwsr/v_out : 0.000000 V
         | "Power Supply: Volts Out"
0.9120.5 pws/pwsr/power_in : 0.000000 W
         | "Power consumed from Line in Watts"
0.9120.6 pws/pwsr/power_out : 0.000000 W
         | "Power given from Power Supply"
0.9120.7 pws/pwsr/disable_alert : Yes range:[0,1]
         | "Enable/Disable the critical alert when the power supply is not plugged"

```

Or specifically list of the corresponding enum values using the `-i e` Option

```

root@zen-425:~# gpa_ctrl -i e hald pws/pwsr/status
{0:'OK', 1:'NOT DETECTED', 2:'POWER OFF', 4:'TEMP PROBLEM', 8:'IN UNDERVOLT', 16:'OUT OVERCURR',
32:'OUT OVERVOLT', 64:'CML ERROR', 128:'DEVICE BUSY', 256:'UNKNOWN', 512:'OTHER ERROR', 1024:'FAN PROBLEM', 2048:'POWER NOT GOOD', 4096:'MFR SPECIFIC',
8192:'VIN PROBLEM', 16384:'OUT PROBLEM', 32768:'VOUT PROBLEM'}

```

You can also display the expert parameters by adding the `-a` flag.

4.5 Other CLI tools

This section enumerates some other tools that are referenced across the user-guide in order to manage the device from the console.

- » `wrz_version`: Legacy tool to get information about version of firmware and hardware.
- » `wrz_flashfw`: Tool used to flash an uploaded firmware (See ["Firmware Update" on page 138](#)).
- » `wrz_logdump`: Tool used to report an error log for the support team (See ["How to report an error" on page 151](#)).

More information about each tool can be found in their respective section or simply by adding the `-h` flag to output the help message embedded in the executable.

Timing

The main purpose of the WR-ZEN is to distribute ultra-accurate synchronization through a timing network.

The device can be configured as a Grand-Master ("[External Reference \(GM\)](#)" on page 79) to retrieve time from an external source and then redistribute it using IEEE1588-2008/PTPv2 or White Rabbit protocols.

Through its virtual clock ("[Virtual Clock Overview](#)" on page 53) centralization system, it allows to combine these protocols in multiple ways and enable resiliency by configuring multiple timing sources. Additionally, an optional Holdover ("[Holdover](#)" on page 84) oscillator can be included to maintain high accuracy (1.5us < 24h after learning 3 days) even if all timing references are down.

Finally, the WR-ZEN family can provide timing to third party devices using ultra precise 10MHz/PPS output signals or through NTP ("[NTP](#)" on page 81) if accuracy is not a strong necessity.

The following topics are included in this Chapter:

5.1 Multi-sources & Resiliency	50
5.2 General Timing Management	54
5.3 White Rabbit	64
5.4 IEEE 1588-2008 (PTPv2)	68
5.5 External Reference (GM)	79
5.6 NTP	81
5.7 Holdover	84
5.8 Miscellaneous	87

5.1 Multi-sources & Resiliency

To ensure continued operation over possible failures, the WR-ZEN incorporates an innovative system that handles multiple timing sources. It also synthesizes these timing sources into a simplified state (a.k.a Virtual Clock State) to ease the monitoring of the device and distributes a common timing information to the down layers.

5.1.1 Timing Sources

The WRZ-OS can handle multiple timing sources in order to discipline the local oscillator of the device. These timing sources can be of different types:

- » External Reference (Front panel connectors)
- » White Rabbit (High-Accuracy PTP)
- » NTP (Survey mode only) → Coming soon!
- » Holdover (Always used as last timing source if available)



Note: PTP as timing source: A pure PTP timing source (slave) should not be selected if the timing is then re-distributed using WR (master). Indeed, the jittered correction run by PTP clock is not compatible with the precision needed for WR/HA distribution. However, a combination of PTP+SyncE as timing source, allows to re-distribute timing using WR without significant penalties.



Note: NTP Timing source (Survey mode): Due to its poor accuracy, NTP protocol is always in Survey Mode and thus cannot actively discipline the local clock.

Then, a maximum total of 5 timing sources of the same or different types can be handled. "[FOCA: The Failover Clock Algorithm](#)" below details the common parameters shared by all the timing sources and how they are used to determine their states.

5.1.2 FOCA: The Failover Clock Algorithm

The FOCA has been designed for the purpose of automatically switching from one timing source to another by applying the following policy:

In case of failure of the active timing source, switch to the next ready timing source.

This algorithm is based on the "Best Master Clock Algorithm (BMCA)" detailed in the PTP IEEE 1588-2019 standard but acts only in case of failure and not when the "best" source

appears in the network. It also enforces the evaluation of the timing sources in a rank order configured by the user. FOCA algorithm has been designed to provide a “safer” approach than BMCA or even ABMCA (Alternate BMCA) to handle switching between multi-references. Its main characteristics are:

- » Provides a deterministic behavior.
- » Does not allow a new (rogue) node to become the active reference.
- » Recovers back to normal state must be done under the supervision of an operator.
- » Allows switching between cross WR/PTP profiles and multiple external timing sources.
- » Has been designed with tree network topology in mind and it is not optimized for ring topology.

The following figure depicts a configuration where the first two timing sources are employing WR protocol, followed by an external GNSS receiver connected to the front panel reference (GM) and finally ending with the holdover to slowly drift until corrective maintenance. It also illustrates how the two strategies of the FOCA algorithm behave.

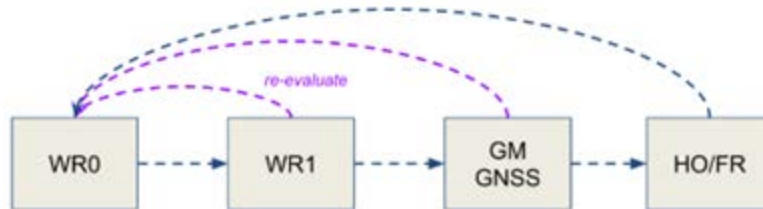

Figure 5-1: Multi-timing sources handle by FOCA policy with its two strategies: only fall-down (blue) & re-evaluation (purple)

An example of the behavior is given by the scenario illustrated in the next image where the following events are shown:

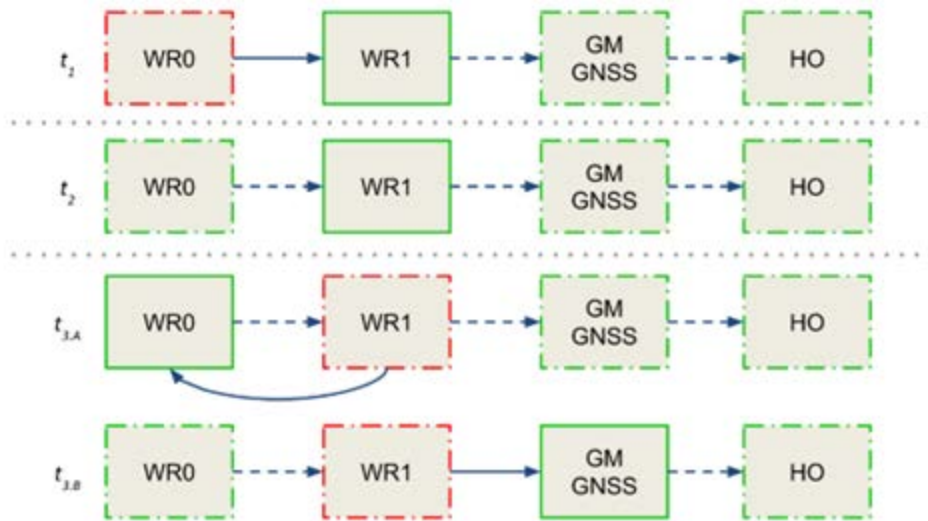

Figure 5-2: FOCA algorithm under scenario 1

- » In t_1 , the active reference (solid green line) is WR1 because the primary reference has reached a CRITICAL state (dashed red line).
- » In t_2 , the primary reference WR0 becomes available again (dashed green line) but the device keeps using WR1 as the active reference as no failure has been detected on this timing source.
- » In t_3 , an error is detected on WR1 and the FOCA algorithm will act differently according to the configuration of its strategy.
 - A. If the strategy is to re-evaluate all timing sources when a failure occurs, and the primary reference is eligible, the WR0 will be selected as the active reference.
 - B. If the strategy is to only fall-down, the FOCA algorithm will select the next available timing source in the list and will thus lock on the external GNSS reference. With this strategy the only way to use back WR0 as the active reference is to restart the devices' synchronization daemon (/etc/init.d/ppsi restart) or to reach the last timing source and wait for a critical error.

Another key aspect of FOCA is how to determine when there is a “failure” on a timing source. Some cases are obvious such as the link is down, no packets are exchange but other cases can be more complex to identify: all these cases are detailed in the appendix VCS code tables (“Grand Master (GM VCS Code)” on page 154).

For a deeper understanding of the behavior of the FOCA algorithm it is recommend reading the section “Others” on page 158 in the appendix where more scenarios are detailed.

Note: FOCA is based on BMCA, thus it is compatible with all the clock quality and timing information fields. In other words, this means that a device running FOCA strategy can provide timing to a BMCA device and BMCA information is provided to FOCA algorithm.

5.1.3 Virtual Clock Overview

The concept of “Virtual Clock” has been introduced in the new version of WRZ-OS to aid monitoring of the global timing status of the device. It allows to abstract the way the timing sources discipline the local oscillator and summarizes how the device will announce its own clock information through the outputs.

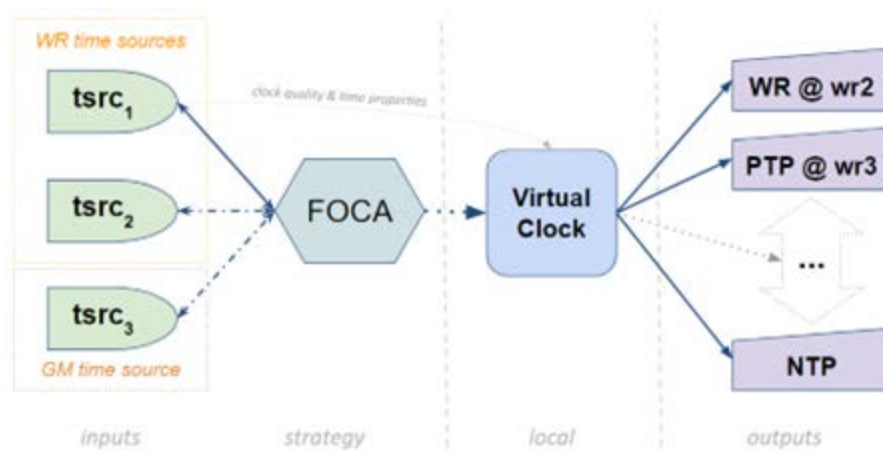

Figure 5-3: Data-flow between timing sources, virtual clock and outputs

When using the FOCA policy (see ["Data-flow between timing sources, virtual clock and outputs" above](#)), the virtual clock will be fed by the active timing source (e.g., tsrc₁), then this information (clock quality & time properties) will be forwarded by all the outputs:

- » directly in case of PTP/WR protocol.
- » by properly modifying the corresponding fields in the case of NTP, NMEA, etc.

The following figure displays the overview panel of the virtual clock information when the device is using an external reference from front-panel (GM) as the active source where:

Sync Overview	
Status	OK
Active Reference	GM: Front-panel
Message	Locked
Date Time	2020-07-16 08:15:59
VCS Code	10000
Clock Identity	64:FB:81:FF:FE:20:88:06
Clock Class	6
Clock Accuracy	<= 100 ns

Figure 5-4: Virtual Clock Overview

- » Status: Summarizes the timing status with Disabled, OK, Warning & Critical values. It is also related to the “Timing Output LED”.
- » Active Reference: A text to inform which timing sources have been selected by the strategy (e.g., FOCA) to actively discipline the device.
- » Message: A helper string to easily identify the corresponding VCS Code.
- » VCS Code: The Virtual Clock Status Code provides a precise but simple way to identify the current timing status of the device. The complete table with all VCS codes is detailed in the Appendix, under ["VCS Code" on page 153](#).
- » Clock Identity, Class & Accuracy: Values announced by the device to inform its own clock information to the timing network. These values are fully compatible with the BMCA defined in the IEEE 1588-2019 (PTP) standard.



Note: Expert Virtual Clock Info: With the expert view enabled (See ["GUI & CGI Tools" on page 35](#)), the user will be able to see all the values announced by the device (e.g., timing source, priority2, etc.)

5.2 General Timing Management

To ease the configuration of the device the WRZ-OS implements presets to allow a quick setup of the timing sources and of the master ports to redistribute time.



Note: If the device has been shipped with the holdover option, this timing source will be, by default, configured as the last timing source independently of the preset.

5.2.1 Presets

5.2.1.1 WR Slave @ wr0 (BC) [default]

- » The primary timing source is provided using WR protocol through interface wr0.
- » The other (wr1) is configured as WR master.

This is the default preset as it is the standard/legacy configuration of most of the WR devices. This is the simplest Boundary Clock behavior where the device is disciplined by a single reference and forward its timing to the down layers through all the other ports.

5.2.1.2 External Atomic Clock (GM)

- » The primary timing source is provided using an external atomic clock reference through the front-panel 10 MHz and 1PPS inputs (Grand-Master).
- » All timing ports (i.e., wr0-wr1) are configured as WR masters.
- » Clock accuracy is announced below or equal to 25 nanoseconds.
- » Alignment of PPS_in VS PPS_out must be done manually (within picoseconds)
- » PPS only needed at startup

It is recommended to use this preset when the device is configured to be the Grand-Master in the timing network and is disciplined using an Atomic Clock as external reference.

Here, Atomic Clocks means that a very stable oscillator based on hyperfine transition (e.g. Caesium) that provides very low daily uncertainties (e.g., 1 ns/day) is combined with a GNSS receiver to remove its slow drift using averaging methods. For telecom, this combination is also known as ePRTC and typically provides a UTC representation accurate within 10 ns or less. Moreover, in order to guarantee the best timing performance (phase noise & determinism) the automatic alignment of the PPS output onto the PPS input has been disabled.



Caution: 10 MHz + PPS signal calibration: When using this preset, the PPS must always keep the same delay in respect to the 10 MHz signal. The user can use the GM Offset field to compensate this fixed delay.

5.2.1.3 External GNSS Receiver (GM)

- » The primary timing source is provided using an external GNSS receiver reference through the front-panel 10 MHz and 1PPS inputs (Grand-Master).
- » All SFP ports (i.e., wr0-wr1) are configured as WR masters.
- » Clock accuracy is announced below or equal to 100 nanoseconds.
- » Alignment of PPS_in VS PPS_out is done automatically (adding ~50ps of uncertainties).
- » PPS_in is mandatory to announce a valid time.

It is recommended to use this preset when a third-party GNSS is providing the reference to the Grand-Master device. This preset will also ensure the automatic alignment of the PPS input to the PPS output after each time the GNSS locked itself.



Caution: GNSS PPS output: The GM can lock to the PPS from the GNSS receiver before GNSS signal locked (before its 10MHz are locked in phase to its PPS). This causes a jump in the time reference. To avoid this situation, the user should configure the GNSS to not output any PPS before locking to GNSS signals.



Note: Inform GNSS status via PPS: This preset enforces a continuous detection of the PPS input. This means that if the GNSS receiver is configured to disable its PPS when it unlocks (e.g., signal lost), the Grand-Master will then automatically degrade itself as a Free-Running Grand-Master (see VSC-10102 in "[Grand Master \(GM VCS Code\)](#)" on page 154).

5.2.1.4 WR Slave @ wr0 → wr1 (BC)

- » The primary timing source is provided using WR through interface wr0. It can fail-over to a secondary timing source provided using WR through interface wr1.

This preset provides multi-source redundancy by allowing to configure the two first optical ports as possible timing sources. This means that in case of failure of the first port (i.e., wr0), the device will automatically switch to wr1 as it is configured as secondary source.

5.2.1.5 WR Slave @ wr0 / PTP Fan-Out

- » The primary timing source is provided using WR protocol through interface wr0.
- » The wr1 is configured as WR master and the ethernet ports (i.e., eth0 & eth1) are configured as PTP masters.

This preset targets devices used as last hop with PTP. The primary timing source is provided using WR protocol through interface wr0. The other port is configured as IEEE 1588-2008 (PTPv2) masters to distribute timing to 3rd party devices.



Note: PTP Master configuration: This preset only configures the role and protocol (PTP or WR) used for all network interfaces with some default settings. A specific configuration of PTP (e.g., Profile, packet rates, etc.) can then be performed under the PTPv2 configuration tab if a valid license has been detected.

5.2.1.6 WR Slave @ wr0>wr1 / PTP Fan-Out

- » The primary timing source is provided using WR through interface wr0. It can fail-over to a secondary timing source provided using WR through interface wr1.
- » The ethernet ports (i.e., eth0 & eth1) are configured as PTP masters.

This preset targets critical devices used as last hop with PTP. The primary timing source is provided using WR through interface wr0. It can failover to a secondary timing source provided using WR through interface wr1.



Note: PTP on copper ports (eth0 & eth1): In v3.x, PTP will be activated on copper ports only while using "PTP Fanout" presets or by manually enabling while forcing the "Custom" preset. In default mode it is disabled.

5.2.1.7 Manual Free-Running

- » The primary timing source is the free running internal oscillator in the device.
- » All SFP ports (i.e., wr0 & wr1) are configured as WR masters.
- » The device announces itself as a Free-running GM using arbitrary timescale (ARB).

This preset is useful for laboratory and test networks where each node is disciplined by the same free-running oscillator. Selecting this preset will also silence the possible warnings in devices of the down-layers and will preclude the use of the holdover as it cannot learn from a free-running oscillator.



Caution: It is highly recommended to avoid integrating a Manual Free-Running device to a timing network in production as in some corner cases the BMCA/FOCA algorithms might select this timing source when it is not the expected choice.

5.2.1.8 Custom

The Custom Preset has been designed to permit modifications of any previous presets in order to meet any kind of user needs. As shown in "[Custom Preset for timing sources configuration](#)" below, it is recommended to:

1. First select a preset which is the most similar to the desired configuration.
2. Then add/modify the different timing sources in the order they should be evaluated by the FOCA algorithm. If the field Type is leaved empty, it will not be evaluated.
3. Finally, each type of timing source will enable its own sub-set of parameters in order to complete the configuration
 - a. For WR type, the user should select the corresponding interface name (e.g., wr0)
 - b. For GM type, you first need to expand (+) the Advanced Configuration to configure the subset specific to a GM time source (see "[VCS Code](#)" on page 153 for more details).

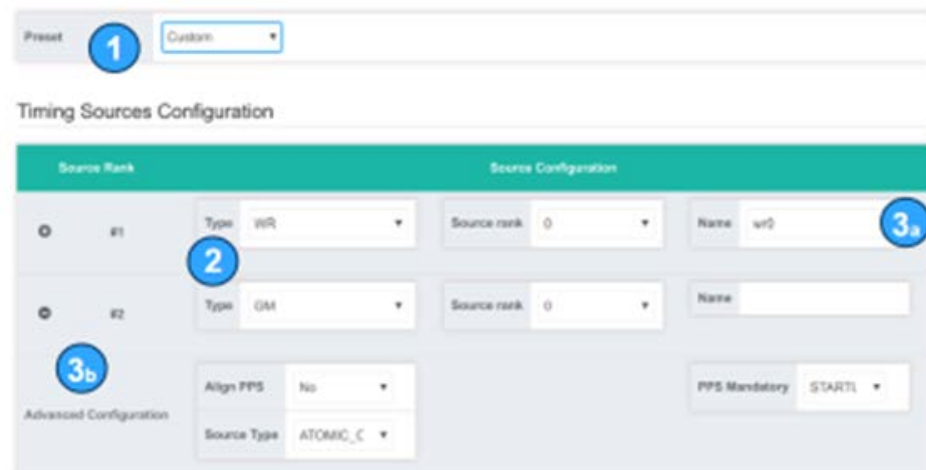

The screenshot shows the configuration interface for timing sources. At the top, a 'Preset' dropdown menu is set to 'Custom', marked with a blue circle '1'. Below this is the 'Timing Sources Configuration' section, which is divided into two columns: 'Source Rank' and 'Source Configuration'. There are two rows of configuration for sources #1 and #2. Source #1 has 'Type' set to 'WR' (marked with a blue circle '2'), 'Source rank' set to '0', and 'Name' set to 'wr0' (marked with a blue circle '3a'). Source #2 has 'Type' set to 'GM' (marked with a blue circle '3b'), 'Source rank' set to '0', and 'Name' is empty. Below the source configuration, an 'Advanced Configuration' section is expanded, showing 'Align PPS' set to 'No' and 'Source Type' set to 'ATOMIC_C'. A 'PPS Mandatory' dropdown menu is set to 'START1'.

Figure 5-5: Custom Preset for timing sources configuration

Note: CLI and Custom Preset: The steps to follow in wrz_config (CLI) are slightly different than in the web as it is needed to select the Custom Preset to bring up the corresponding subset of parameters to the menu. If the Custom preset is not chosen in advance, these parameters will stay hidden and thus not configurable.

Fanout ports configuration

The presets define the type of protocol selected for all the interfaces. If the user needs a specific combination that mixes WR on some ports and PTP/IEEE-1588 on others, he/she first select the Custom preset and then configure the Fan-out ports.

Through Web

After applying the Custom profile under the Timing > General > Configuration tab, the user might need to wait few seconds until the preset is completely loaded.

Then by clicking on the (+) icon of the Fanout Configuration panel, all the remaining interfaces will be available for configuration. The user should then just change the protocol used by a specific interface and its role (e.g, in the figure below, the wr4 port is used as PTP master).

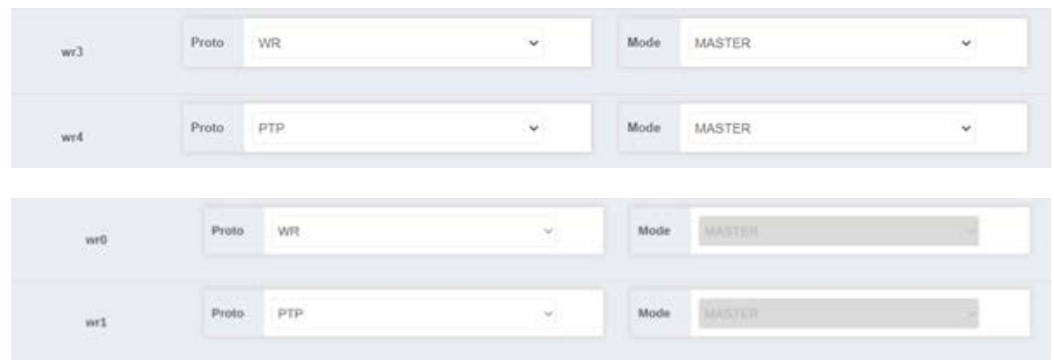

Figure 5-6: Mixing PTP and WR master ports (wr0 & wr1)

Through CLI

As shown in "[Custom Preset with CLI tool](#)" on the next page, the user first needs to select the preset=Custom to reveal the Ports Configuration submenu and other parameters.

```

*** Timing configuration parameters ***
preset (Custom) ---->
Ports Configuration ---->
White Rabbit ---->
PTP / IEEE 1588 ---->
Grandmaster ---->
Holdover ---->
NTP ---->
Miscellaneous ---->

```

Figure 5-7: Custom Preset with CLI tool

Then each port can be configured independently with:

- » Protocol: WR, PTP, Disabled
- » Role: Master, Slave, Auto, Survey
- » Source Rank: [0-255], Order the timing source given the source rank priorities where:
 - » 1 is the first source to be executed and 255 the last one.
 - » If the source rank is set to 0, the port will not be included as a timing source.
 - » This parameter is not used when the port role is Master.

```

.config - wrzTP Family Configuration
> Timing > Ports Configuration > wr0
wr0
Arrow keys navigate the menu. <Enter> selects submenus ----> (or empty
submenu ----). Highlighted letters are hotkeys. Pressing <Y> includes,
<N> excludes, <M> modularizes features. Press <Esc><Esc> to exit, <?>
for Help, </> for Search. Legend: [*] built-in [ ] excluded <M> module

*** wr0 configuration parameters ***
(1) src_rank (NEW)
proto (WR) ---->
mode (SLAVE) ---->

<Select> < Exit > < Help > < Save > < Load >

```

Figure 5-8: Port configuration (e.g., wr0) from CLI tool

Note: PTP modes on Custom preset: The Custom preset allows to configure any desired interface as PTP master through Web and CLI. However, PTP slave mode in ethernet ports can only be configured through the CLI.

5.2.2 Reference topology

The following figure summarizes how devices can be configured with different presets to operate on a generic timing network. To improve the comprehensibility of the reader, this reference topology has been separated in several theoretical layers:

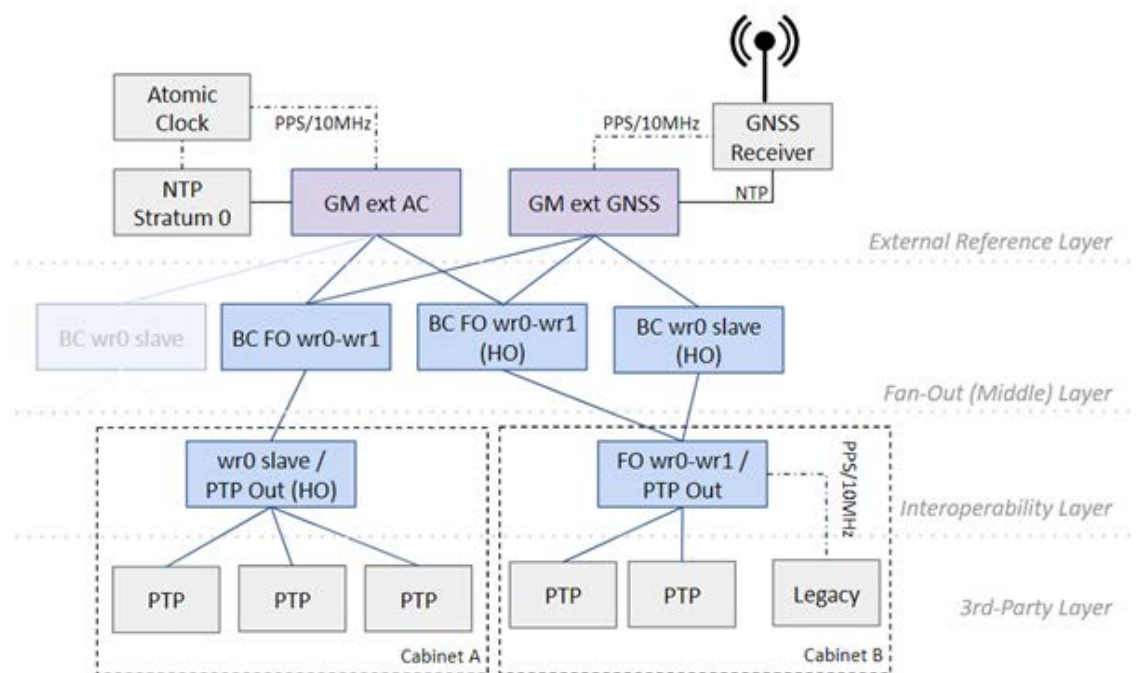

Figure 5-9: Reference topology with different presets.

- » External Reference Layer: It includes the devices that will be fed by several external references (in grey), such as an Atomic Clock or a GNSS receiver, and will receive ToD (Time of Day) from an NTP server (external or embedded). These devices will act as Grand-Master (GM) in the timing network and their timing information will be forwarded to all the timing nodes.
- » The Fan-Out Layer or Middle Layer: The devices in this layer are mainly dedicated to spread (fan-out) the timing synchronization to more devices on the down layers. In order to ensure continuous operation, they can be configured with redundant timing sources (e.g., BC FO wr0-wr1) or could incorporate the Holdover option (e.g., BC wr0 slave HO).

- » The interoperability Layer: The devices that belong to this layer are also known as last-hop devices. Typically, one of these devices is placed per rack cabinet and is in charge of distributing the ultra-accurate timing provided by the White Rabbit network to other 3rd party devices in the cabinet via PTP, via 10MHz/PPS (legacy devices), etc.

Note: This reference topology is a simplified version of a real timing network and the proposed structure in layers might not be respected: A last-hop device could be connected directly to the GM or an external GNSS reference could be used as backup in the fan-out/interoperability layer.

Note: Some devices in the reference topology strategically include the hold-over option (HO) to ensure continuous operation even if not locked to any timing sources. This option is automatically enabled if detected and the provided presets can be used without any modifications.

5.2.3 Timing source info

Each timing source shares a common set of values processed by the strategy in order to decide how to discipline the virtual clock of the device.

By clicking on the tabs Timing > General the user will be able to quickly get an overview of the state of all timing sources. The figure below shows the parameters related to the primary (#1) timing source.



Figure 5-10: Info for Timing Source #1

The parameters contained in the previous table are described as follows:

OID	Name	Value	Description
3.13x0.x	tsrc_info/x/xxx		Information about the <u>x</u> timing source.
3.13x0.1	Name	<String> (i.e., wr0, front-panel, eth1, etc.)	Name of the corresponding timing source.

OID	Name	Value	Description
3.13x0.2	Type	GM WR PTP HO/FR	Type of timing source, each type can have slightly different state machines to properly handle its timing source.
3.13x0.3	VCS Code	<Integer>	Code defined in the VCS table (" VCS Code " on page 153) that corresponds to a given condition for this timing source.
3.13x0.4	Status	Disabled OK Warning Critical	Status that corresponds to the code defined in the VCS table.
3.13x0.6	Is Active	<Boolean>	Flag that indicates if this timing source has been selected by the policy to actively discipline the virtual clock of our device.

The timing source can be expanded to show its advanced view by clicking on the (+) button:

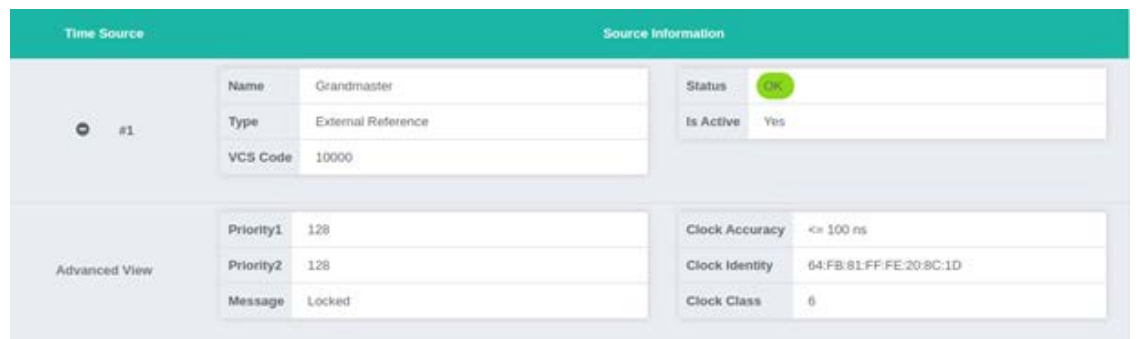

Figure 5-11: Advanced info Timing Source #1

The advanced view parameters are described below:

Table 5-1: Timing source info description

OID	Name	Value	Description
3.13x0.xx	tsrc_info/x/xxx		Information about the x timing source.
3.13x0.5	Message	<String>	Message that corresponds to the code defined in the VCS table.
3.13x1.xx	tsrc_info/x/Q		Clock Quality of the x timing source.
3.13x1.1	Clock Identity	<String>	Unique identity of PTP instance in the network.

OID	Name	Value	Description
3.13x1.2	Priority1	<Integer> Default: 128	Force BMCA decision using 1st priority (Lower values take precedence).
3.13x1.3	Priority2	<Integer> Default: 128	Manually force BMCA to select a clockID when clock quality is the same (Lower values take precedence).
3.13x1.10	Clock Class	<Integer> Default: 248	The Clock Class is one of the attributes that characterizes the timing source.
3.13x1.11	Clock Accuracy	<Enum>	It indicates the expected accuracy of the timing source. It shall be conservatively estimated based on the time source.

For example, Figure ["Info for Timing Source #1" on page 62](#) shows that the primary timing source is currently active but with a warning state and its corresponding VCS code #10201. By expanding the advanced view (Figure ["Advanced info Timing Source #1" on the previous page](#)), the user can easily verify that this warning is caused by the fact that the time of day (ToD) is not properly set due to an NTP Error.

5.3 White Rabbit

5.3.1 Configuration

After configuring if White Rabbit is a Slave (Timing Source) or a Master port, the only configuration that might be realized is which Transport Protocol should be used.

By default, WR uses the data layer (RAW Ethernet packets - IEEE 802.3) to communicate to other WR devices but it can be configured to also use the UDP/IPv4 packets.



Figure 5-12: Configuration of WR instance.

5.3.2 Info/Overview

5.3.2.1 Active servo

When the device is running as a WR Boundary Clock, this means that one of the fiber network interfaces is an active slave. The data related to how the servo disciplines the internal

oscillator can thus be visualized under the active servo panel.

OID	Name	Value Type	Description
1.1220.x	act/servo		Information about the active servo instance
1.1220.1	Interface Name	<String>	Name of the network interface on which the servo is running.
1.1220.6	State	0. Disabled 1. Adjusting Time 2. Adjusting Phase 3. Adjusting Phase 4. Locked 5. Wait Stable Phase 6. Invalid 7. Undefined 8. Not Updated 9. Wait Time Adjust 10. Wait Phase Adjust 11. Initializing	Servo State: where 'Locked' corresponds to the legacy TRACK_PHASE state and means that the corresponding interface is actively disciplining the device. Disabled is used when the port is setup as Master or does not receive any valid PTP/WR exchange. Note: The 1st state corresponds to adjustments in seconds order, and the 2nd one to adjustments in nano-seconds order.
1.1220.5	Up Count	<Integer> (u32)	Number of updates for the servo. It is typically increased by 1 each second.
1.1220.10	Mean Delay	<Decimal> (f64) Unit: s	Cable round trip time excluding fixed+semistatic (cRTT).
1.1220.11	Delay MS	<Decimal> (f64) Unit: s	Calculated Delay between Master and Slave considering asymmetry and fixed delays.
1.1220.21	Egress Latency	<Decimal> (f64) Unit: ns	Fixed latency between the moment when a PTP packet is timestamped to its exit on the physical layer (i.e., optical fiber). Legacy: 'WR Slave ΔTx'.
1.1220.20	Ingress Latency	<Decimal> (f64) Unit: ns	Fixed latency between the moment when a PTP/WR packet ingresses from the physical layer to its timestamp. Legacy: 'WR Slave ΔRx'.

5.3.2.2 Port Instance

A WR port instance is then associated to each network interface. The table displayed in the following image provides a quick overview of the state of each interface.



Interface	Link	Port State	Clock State	Source Rank	Peer MAC	Peer VID	N Tx PTP	N Rx PTP
wr0	Up	Slave	Locked to REF	1	08:00:30:2C:3E:51	0	102383	231427

Figure 5-13: WR Interfaces overview (Only first interface captured (wr0)).

The parameters shown are explained in the following table:

OID	Name	Value Type	Description
1.xx10.x	net/wrX/1/		Information about WR for the wrX network interface. (Where OIDs follow the given pattern: wr0 → 20xx, wr1 → 21xx, ..., wr15 → 35xx)
1.xx10.5	Link	Down Up	Specify if the link is up or down.
1.xx10.10	Port State	0. None 1. Initializing 2. Faulty 3. Disabled 4. Listening 5. Pre-Master 6. Master 7. Passive 8. Uncalibrated 9. Slave	Current state of the port that changes according to the PTP protocol events. <ul style="list-style-type: none"> • If this port is configured as a timing source, it can be Slave (active) or Passive (only handle announce messages) → Color: Blue. • The port state is Disabled when the link is down or when the port has been configured with PTP instead of WR. • The port state will be Master if it distributes WR timing (Color: Purple). • Finally, the other states are transition states (mainly used by BMCA) or error states.
1.xx10.11	Clock State	0. Idle 1. Locking 2. Locked to REF 3. Holdover 4. Error 5. Free-Running	State of the clock (internal oscillator) shared by all PTP instances. "Locked to Ref" is the desired stated.
1.xx10.20	Peer MAC	<Data Array> (6 x u8)	MAC address of the latest peer.
1.xx10.23	Peer VID	<Integer> (u16)	VLAN ID of the connected peer.
1.xx10.25	Peer N Tx PTP	<Integer> (u32)	Number of transmitted PTP packet on this port.
1.xx10.26	Peer N Rx PTP	<Integer> (u32)	Number of received PTP packet on this port.

If the interface is currently running WR ("Port State" not "Disabled"), the user can expand (+) a specific interface to display an Advanced Overview (See the figure below):

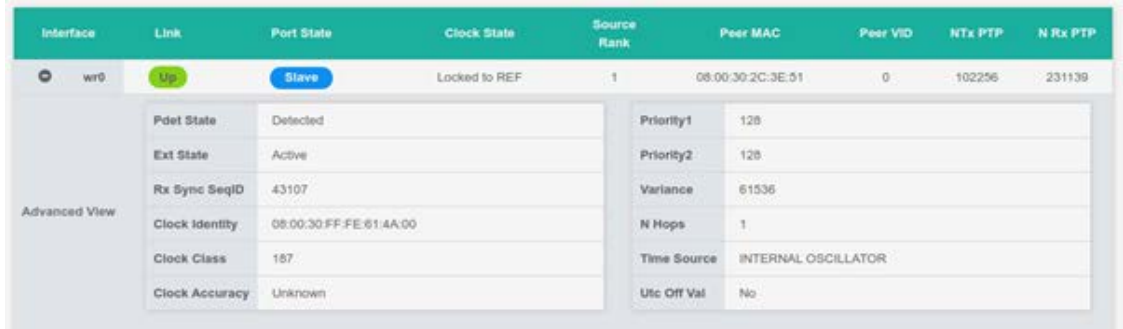

Figure 5-14: Advanced WR interface Overview (WR0 configured as slave)

Note: The clock information (clock quality & time properties) displayed in the expanded view above corresponds to the announced messages received on this specific interface and not the transmitted ones. This information is irrelevant (disabled) if the link is down or when the connected peer is not sending any announce messages (e.g., slave role).

The information shown in the advanced overview menu is explained in the following table:

OID	Name	Value Type	Description
1.xx10.x	net/<wrX>/1/		Information of the corresponding WR port instance (wrX). (Where OIDs follow the given pattern: wr0 → 20xx, wr1 → 21xx, ..., wr15 → 35xx)
1.xx10.6	PDet State	0. None 1. Waiting 1st Msg 2. Checking 3. Detected 4. Failure	State of the Protocol Detection.
1.xx10.5	Ext State	0. Disabled 1. Active 2. PTP Only	State of the extension. If PTP Only this means that the WR extension has not been detected.
1.xx10.5	Rx Sync ID	<Integer> (u16)	Receive Sync Sequence ID.
1.xx10.5	Peer VID	<Integer> (u16)	VLAN ID of the connected peer.
1.xx31.xx	net/<wrX>/1/clk/Q/		Clock Quality of the corresponding WR port instance (wrX).
3.13x1.1	Clock Identity	<Data Array> (8 x u8)	Unique identity of PTP instance in the network.

OID	Name	Value Type	Description
1.xx31.2	Priority1	<Integer>	Force BMCA decision using 1st priority (Lower values take precedence).
1.xx31.3	Priority2	<Integer>	Used by BMCA to force selection between two clocks when their clock qualities are the same (Lower values take precedence).
1.xx31.10	Clock Class	<Integer>	The Clock Class is one of the attributes that characterizes the port instance.
1.xx31.11	Clock Accuracy	<Enum>	It indicates the expected accuracy of the timing source. It shall be conservatively estimated based on the time source.
1.xx31.12	Variance	<Integer> (u16)	Estimation of the variations of the Local PTP Clock as measured by comparison to a suitable reference clock.
1.xx31.20	N Hops	<Integer> (u32)	Number of PTP communication paths traversed between this PTP instance to the GrandMaster PTP Instance (aka stepsRemoved).
1.xx32.xx	net/<wrX>/1/clk/tprop/		Time Properties of the corresponding WR port instance (wrX).
1.xx32.1	Time Source	<Enum>	This information-only attribute indicates the immediate source of time used by the Grandmaster.
1.xx32.12	UTC Offset Valid	<Bool>	True, if the current UTC offset is known to be valid (It will handle the next leap second jump).



Note: To obtain more details about time properties & clock quality of a given WR port instance, the user should use `gpa_ctrl` tool with the `-a` (expert) flag or with the `-A` (expert & disabled) flag.

5.4 IEEE 1588-2008 (PTPv2)

The IEEE 1588-2008 (PTPv2) module offers interoperability with a wide range of 3rd party devices. It has been specifically designed to work as PTP master while supporting the following profiles:

- » Default
- » Telecoms profiles:
 - » G.8265.1
 - » G.8275.1+Sync-E
- » Power profile: IEEE C37.238-2011

 **Caution:** Limitation on packet rate: It is not recommended to distribute PTP at full packets rate (128 pkt/s) on all its 16 network interfaces at the same time. In advanced configuration the user can modify CPU priorities to avoid dropping packets on most critical ports. Unicast negotiation can also be used to smartly decrease the packet rate depending on CPU load.

5.4.1 License

 **Note:** PTP License: A specific license must be purchased in order to get full access to the IEEE 1588-2008 (PTPv2) module. When no license is provided, the PTP instance will start with default profile and parameters. The user will only be allowed to configure the Role of the port (Master, Slave & Disabled).

The following table compares the configuration of IEEE-1588 (PTP) when using or not a valid license. It is worth highlighting that without license the PTP master instances will announce themselves with default constant values instead of forwarding the VCS clock information from the active timing source ("[Virtual Clock Overview](#)" on page 53)

Table 5-2: IEEE 1588 configuration with/without license

PTP	With License	Without License
Mode	Auto, Master, Slave, Disabled	Master, Slave or Disabled
BMCA	Enabled or Disabled	Disabled
Transfer mode	Multicast or Unicast	Multicast
Unicast Negotiation	Enabled or Disabled	Disabled
Delay Mechanism	End to End (E2E) or Peer to Peer (P2P)	End to End (E2E)
Network mode	IPv4 or Ethernet (layer 2)	IPv4
Domain	0-255	0
Announce ratio	[1 msg/16s,16 msg/s] ([-4,4])	1 msg/s

PTP	With License	Without License
Sync ratio	[1 msg/128s,128 msg/s] ([-7,7])	1 msg/sec
Delay Req ratio	[1 msg/128s,128 msg/s] ([-7,7])	1 msg/sec
Clock Quality & Timing Properties		
Clock Class	From VCS or user defined (0-255)	248
Priority1	From VCS or user defined (0-255)	128
Priority2	From VCS or user defined (0-255)	128
Clock Accuracy	From VCS (See "External Reference (GM)" on page 79)	Unknown
Variance	From VCS	65535 (maximum)
Timing Source	From VCS (See "External Reference (GM)" on page 79)	OTHERS
Traceability Flags	From VCS	False
PTP Timescale	From VCS or user defined	True
UTC Offset	From VCS	37
Advanced Settings		
Offset correction	Any number (in nanoseconds)	0
Servo Fit Algorithm	Normal, Soft, Hard, Hardx2	Normal

5.4.1.1 PTP license management

All the topics related to PTP license management such as purchasing, activating and checking are explained within the Licenses section (["Licenses" on page 132](#)).

Once the license is activated (see image below) the web interface should allow the user to configure these settings as explained in ["Configuration" on the facing page](#).



Figure 5-15: Unlicensed VS Licensed PTP daemon

 **Note:** The CLI tool allows to modify and save all the parameters listed in "IEEE 1588 configuration with/without license" on page 69 even without license. However, they will not be Applied/Loaded until the PTP license is validated.

5.4.2 Configuration

 **Note:** Master/Slave port configuration: The role of the port is given by the Preset ("Presets" on page 55) and cannot be modified directly from the PTPv2 configuration tab. The section "Custom" on page 58 should be read in case the user needs to modify the role for a specific port.

 **Note:** PTP provides many options to support a wide range of applications. Then, the PTP profiles restrain some specific settings in order to limit compatibility to only a subset of PTP. The user should thus consider these restrictions when configuring PTP for a specific profile.

The parameters associated to PTP are listed below:

OID	Name	Value Type	Description
19.xx13.x	net/<iface>/1/cfg		Configuration of the corresponding <iface> port instance.
19.xx13.8	Profile	0. Default 1. Custom 2. Telecom 8275.1 3. Telecom 8265.1 4. C37.238-2011 Power	Profile selected (Default, telecom...) with a set of options pre-configured.
19.xx13.9	Transport Protocol	5. Layer 2 6. UDP/IPv4	Define the network layer that delivers the PTP packets.
19.xx13.10	Delay Mechanism	0. E2E 1. P2P	Path delay measuring mechanism used by the PTP Port {E2E (End to End delay request-response mechanism), P2P (Peer to Peer delay mechanism)}.
19.xx13.14	Domain	<Integer> [0-255] Default: 0	Domain number associated to the PTP transactions. Several domains can work simultaneously. PTP profiles can restrict the value of domain number (i.e., 8275.1)

OID	Name	Value Type	Description
19.xx13.11	Transport Mode	0. Multicast 1. Unicast	By default, multicast is used to automatically discover the PTP peers. When unicast mode is selected, the PTP topology must be pre-defined by filling unicast destination.
19.xx13.12	Unicast Negotiation	<Bool>	Enable unicast negotiation support. This option is needed by ITU-T G8265.1
19.xx13.13	Unicast Destination	<String>	IPv4 address (or coma separated list of IPv4 addresses). Mandatory for slave unicast as they must request to a predefined GM(s). Mandatory for GMs with unicast negotiation disabled as they must deliver to a pre-configured group of slaves.
19.xx13.56	Sync-E	<Bool>	Disable/Enable Sync-E operation mode
19.xx13.20	Announce Rate	<Enums> Default: 1 packet/s	Rate of announce messages transmitted to be used by BMCA/FOCA. From 1 packet each [2,4,8,16,32,128] seconds to [1,2,4,8,16] packets per second.
19.xx13.21	Sync Rate	<Enums> Default: 1 packet/s	Rate of sync (and follow-up) messages from master to slave (Figure " Simplified PTP packets exchange for delay measurement (1) End-to-end (2) Peer-to-peer. " on the facing page). From 1 packet each [2,4,8,16,32,128] seconds to [1,2,4,8,16,32,61,128] packets per second.
19.xx13.22	Delay Req Rate	<Enums> Default: 1 packet/s	Rate of delay request from slave to master. From 1 packet each [2,4,8,16,32,128] seconds to [1,2,4,8,16,32,61,128] packets per second.
19.xx13.23	Peer Delayreq Rate	<Enums> Default: 1 packet/s	Rate of Peer delay request when operating in P2P mode. From 1 packet each [2,4,8,16,32,128] seconds to [1,2,4,8,16,32,61,128] packets per second.
19.xx13.18	User offset	<Integer> Default: 0 ns	User offset to compensate internal PTP delay.
19.xx13.24	PTP Timescale	<Enum> 1. PTP 2. ARB	By default the "PTP" timescale distribute the best estimate of standard TAI timescale include the UTC offset. If the user application does not need to be "traceable" to UTC/TAI, the user can define its own timescale and inform the network that timescale is arbitrary (ARB),
9.xx12.x	net/<iface>/server/cfg/		Configuration of the ESMCd daemon
9.xx12.1	Force SSM Code	<Enum> - Auto QL PRC QL SSU A QL SSU B QL SEC QL DNU	SSM code provide by the ESMCd daemons. When Auto the SSM code will be automatically selected depending on the state of the device (i.e., QL PRC when locked to external ref, QL DNU when free-running)

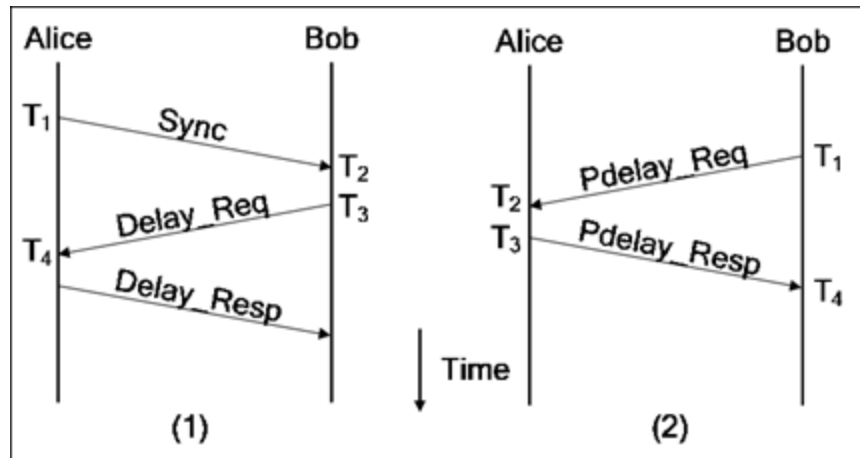

Figure 5-16: Simplified PTP packets exchange for delay measurement (1) End-to-end (2) Peer-to-peer.

5.4.2.1 Configuration of PTP Profiles

A valid license is needed to perform the configuration of PTP profiles.

The easiest way to configure a specific PTP profile is through the web interface. The user can quickly select its desired profile as illustrated in below and then all the related settings will be modified accordingly to fit the selected profile.

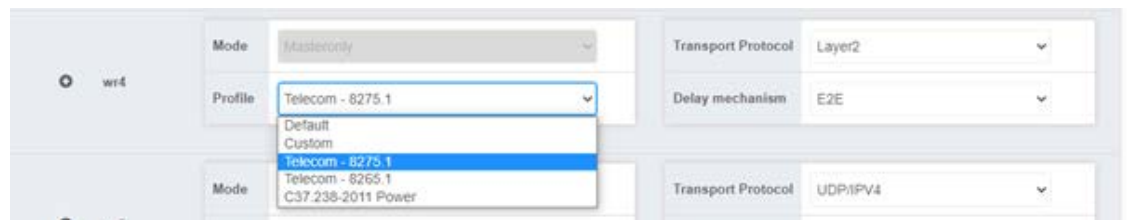

Figure 5-17: Selecting ITU-G 8275.1 Telecom profile for wr4 interface

Then if some advanced settings need to be modified the user can click on the (+) button to expand the configuration of a given interface.

Note: Custom Profile: In case some (advanced) settings are modified not accordingly to the specification of the selected profile the web interface will automatically change to use the Custom profile. It will not restrict the user to any configuration.

The tables below summarize the limitation of the configuration for the different PTP profiles supported by the WR-ZEN device. Worth mentioning that some of the settings have

no default value but must fit with a specific range. Strikethrough settings are ignored by the profile and can be leaved empty or with previous value.

Telecom ITU-T 8275.1

The objective of this profile is to distribute accurate time over a full timing support network with sync-e capability.

OID	Name	Default Value	Range		Note
			Min	Max	
19.xx13.x	net/<iface>/1/cfg				
19.xx13.9	Transport Protocol	Layer 2 (IEEE802.3)			VLAN tags not allowed
19.xx13.10	Delay Mechanism	E2E			
19.xx13.14	Domain	24	23	48	
19.xx13.11	Transport Mode	Multicast			
19.xx13.20	Announce Rate	8			
19.xx13.21	Sync Rate	16			
19.xx13.22	Delay Req Rate	16			
19.xx13.24	PTP Timescale	PTP			
19.xx13.56	Sync-E	Enabled			

Telecom ITU-T 8265.1

The objective of this profile is to distribute frequency within 16 ppb over a network with some non-aware PTP nodes.

OID	Name	Default Value	Range		Note
			Min	Max	
19.xx13.x	net/<iface>/1/cfg				
19.xx13.9	Transport Protocol	IPv4/UDP			
19.xx13.10	Delay Mechanism	E2E			
19.xx13.14	Domain	-	4	23	
19.xx13.11	Transport Mode	Unicast			
19.xx13.12	Unicast Negotiation	True			
19.xx13.13	Unicast Destination	<IP>			
19.xx13.20	Announce Rate	1/2	1/16	8	
19.xx13.21	Sync Rate	-	1/16	128	

OID	Name	Default Value	Range		Note
			Min	Max	
19.xx13.22	Delay Req Rate	-	1/16	128	
19.xx13.24	PTP Timescale	PTP			
19.xx13.56	Sync-E	Disabled			

Power Profile: IEEE C37.238-2011

This profile has been created to target Power Systems Applications.

OID	Name	Default Value	Range		Note
			Min	Max	
19.xx13.x	net/<iface>/1/cfg				
19.xx13.9	Transport Protocol	Layer 2 (IEEE802.3)			VLAN tags (IEEE802.1Q) are mandatory, with a default priority of 4, and default VLAN ID of 0.
19.xx13.10	Delay Mechanism	P2P			
19.xx13.14	Domain	0	0	127	
19.xx13.11	Transport Mode	Multicast			
19.xx13.20	Announce Rate	1			
19.xx13.21	Sync Rate	1			
19.xx13.23	Peer Delay req Rate	1			
19.xx13.24	PTP Timescale	PTP			
19.xx13.56	Sync-E	Disabled			

5.4.3 Info/Overview

Each PTP port runs its own PTP instance independently on a specific process. The information about the instance can be obtained from command line, using for example the following command for the first port (wr0):

```
gpa_ctrl wptpd net/wr0/1/info/
```

Or through the web interface as shown below, where each port is displayed by a row (see the table "[PTP information for a port interface](#)" on the next page for more details on the provided parameters).

Interface	Port State	Clock State	Servo State	Source Rank	Sync Mode	Rx Sync Packets	Tx Sync Packets	Rx Delayreq Packets	Tx Delayreq Packets
eth0	None	Idle	Disabled	-	Two Step	0	0	0	0
eth1	None	Idle	Disabled	-	Two Step	0	0	0	0
wr0	None	Idle	Disabled	-	Two Step	0	0	0	0
wr1	Master	Locked to Ref	---	-	Two Step	0	396331	0	0

Advanced View	
State Transitions	0
State Reason	Unknown
Calculated Offset	-1.000000000 s
One-Way Delay	-1.000000000 s
Mean Path Delay	-1.000000000 s

SyncE	
SyncE State	Unlocked
SSM code	No initialized

Figure 5-18: wr0 port as active PTP slave with its advanced view expanded.

Table 5-3: PTP information for a port interface

OID	Name	Value Type	Description
19.xx12.x	net/<iface>/1/info		Information on the corresponding <iface> port instance.
19.xx12.2	Port State	<Enum> 0. None 1. Initializing 2. Faulty 3. Disabled 4. Listening 5. Pre-Master 6. Master 7. Passive 8. Uncalibrated 9. Slave	Current state of the port that changes according to the PTP protocol events. <ul style="list-style-type: none"> If this port is configured as a timing source, it can be Slave (active) or Passive (only handle announce messages) → Color: Blue. The port state is Disabled when the link is down or when the port has been configured with WR instead of PTP. The port state will be Master if it distributes PTP timing (Color: Purple). Finally, the other states are transition states (mainly used by BMCA) or error states.
19.xx12.3	Clock State	<Enum> 0. Idle 1. Locking 2. Error 3. Locked to Ref 4. Free-running	State of the clock (internal oscillator) shared by all PTP instances. "Locked to Ref" is the desired stated.

OID	Name	Value Type	Description
19.xx12.4	Servo State	<Enum> 0. Disabled 1. --- 2. Waiting Sync Sec (+) 3. Waiting Sync Sec (-) 4. Error 5. Frequency estimation 6. Tracking 7. Not updated 8. Locked	State of the PTP servo. For a port set as slave, the servo should reach the "Locked" state to properly perform the synchronization. NOTE: The state "---" has been created for PTP master ports because for this mode the servo state is irrelevant.
19.xx12.12	Mode of Operation	<Enum> 0. Two Step 1. One Step 2. Disabled	Reports the current mode of operation received from the master. Two steps=Sync+FollowUp, One step=Sync
19.xx12.26	Rx Sync Packets	<Integer>	Number of received sync messages (Incrementing for Slave instances)
19.xx12.31	Tx Sync Packets	<Integer>	Number of transmitted sync messages (Incrementing for Master instances)
19.xx12.28	Rx DelayReq Packets	<Integer>	Number of received delay request message (Incrementing for Master instances)
19.xx12.33	Tx DelayReq Packets	<Integer>	Number of received delay request message (Incrementing for Slave instances)

Then if a specific interface is not disabled (Port State \neq None), by clicling on the (+) a user will expand the interface to its Advanced View to get more information about the PTP exchange. The bi-directional exchanges of PTP is resumed in "[Simplified PTP packets exchange for delay measurement \(1\) End-to-end \(2\) Peer-to-peer.](#)" on page 73, where the number of packets for each type of messages is provided by the parameters in advanced view (see the table below).

Table 5-4: Advanced PTP information for a port instance

19.xx12.x	net/<iface>/1/info		Information on the corresponding <iface> port instance.
19.xx12.2	Calculated Offset	<Decimal> (f64)	The value represents the actual offset (in seconds) between master and slave. It is calculated from the retrieved timestamps with corrections from calibrations & asymmetries settings.
19.xx12.3	One-Way Delay	<Decimal> (f64)	One-way path delay in seconds (equivalent to delay_MS)

19.xx12.26	Rx Sync Packets	<Integer>	Number of received sync messages (Incrementing for Slave instances)
19.xx12.28	Rx DelayReq Packets	<Integer>	Number of received delay request message (Incrementing for Master instances)
19.xx12.25	Rx DelayReq Packets	<Integer>	Number of received announce messages (Incrementing for Slave/Passive instances)
19.xx12.27	Rx DelayReq Packets	<Integer>	Number of received Follow up messages (Incrementing for Slave instances with Two Steps)
19.xx12.29	Rx DelayReq Packets	<Integer>	Number of received Delay Response messages (Incrementing for Slave instances when a PTP exchange is completed)
19.xx12.31	Tx Sync Packets	<Integer>	Number of transmitted sync messages (Incrementing for Master instances)
19.xx12.33	Tx DelayReq Packets	<Integer>	Number of received delay request message (Incrementing for Slave instances)
19.xx12.30	Tx Announce Packets	<Integer>	Number of transmitted announce messages (Incrementing for Master instances)
19.xx12.32	Tx FollowUp Packets	<Integer>	Number of transmitted Follow up messages (Incrementing for Slave instances with Two Steps)
19.xx12.34	Rx DelayResp Packets	<Integer>	Number of transmitted Delay Response messages (Incrementing for Master instances each time a DelayReq is received)
19.xx62.4	Sync-E State	<Enum> 0. Unknown 1. Locked 2. Unlocked	State of the sync-E slave
19.xx21.2	SSM Code	<Enum> - Not Initalized - QL PRC - QL SSU A - QL SSU B - QL SEC - QL DNU	SSM code received by ESMCd client in the last event packet



Note: ESMCd module: For an enhanced monitorization of Sync-E layer the user can directly retrieve the value exchanged by the ESCMd module by executing the command `gpa_ctrl esmcd`.



Note: PTP in management ports (Eth): In scenarios with a high load of traffic, a non-optimal amount of timestamps is lost through copper ports (eth management ports). However, this behavior does not appear in optical ports. Hence, even though this functionality has been saved to keep the compatibility with previous firmware architectures, it is not recommended to use PTP through management ports.

5.5 External Reference (GM)

5.5.1 Configuration

The Configuration of the GM is partially done by the Preset and then by the Configuration Tab under the Timing > External Reference (GM) section.

If the user selects the Custom Preset it might be able to configure the following parameters when expanding (+) to the Advanced View for the GM source type:

OID	Name	Value Type	Description
3.7110.x	gm/cfg/xxx		Configuration of the GM timing source (By Preset).
3.7110.2	Align PPS	<Boolean>	Enable this to align the PPS output to the PPS input during the locking procedure. It should be enabled when using a GNSS receiver as external reference as PPS might be shifted from 10MHz after each GNSS relock.
3.7110.4	Source Type	<ul style="list-style-type: none"> • ATOMIC CLOCK • GNSS • PTP • OTHER 	Type of timing source announced by the GM. It should correspond to the type of external reference that provides 10MHz/PPS to the front-panel of the device. (This field is informative and not used for decision making).
3.7110.7	PPS Mandatory	<ul style="list-style-type: none"> • YES • NO • STARTUP_ONLY 	Controls whether an PPS input signal is needed to enter/stay active for the GM source.

The user can also configure the following parameters independently from the chosen preset:

OID	Name	Value Type	Description
3.7110.x	gm/cfg/xxx		Configuration of the GM timing source (By Preset).

OID	Name	Value Type	Description
3.7110.1	GM Offset	<Integer> Default: 0	Offset to compensate user cable delay for PPS input (in picoseconds). When Align PPS is enabled the PPS output should be aligned to the PPS input but the user might want to compensate this delay.
3.7110.2	Priority1	<Integer> Default: 128	PTP Priority1 announced when the GM is active. It is mainly used by BMCA to force the best-clock selection using 1st priority (Lower values take precedence).
3.7110.3	Priority2	<Integer> Default: 128	PTP Priority2 announced when the GM is active. It is mainly used by BMCA to force the choice between two references when their clock qualities are the same (Lower values take precedence).
3.7110.11	Clock Accuracy	<Enum> Default: Unknown	It announces the expected accuracy provided by the external reference. It shall be conservatively estimated based on the type of time source (e.g., Atomic Clock <= 1ns, GNSS receiver <= 50ns).



Caution: If GM is used as a timing source, it should always be associated to the configuration of at least one NTP server to properly recover the time of day (ToD).

5.5.2 Info/Overview

The GM timing source provides its own overview panel where the user can easily audit the condition of its external reference (see figure below).

Overview

Message	Locked	Detected	PPS & CLK
Source Rank	1	Align PPS	No
Source Type	ATOMIC_CLOCK	PPS Mandatory	STARTUP_ONLY

Leap Second File

Expiration Date	2020-06-28 00:00:00
Valid	Yes

Figure 5-19: Overview tab for GM timing source.

It basically offers a readback of the configuration value (Source Type, Source Rank, Align PPS and PPS Mandatory) as detailed "[Configuration](#)" on the previous page, along with a user friendly Message that summarize the state of the GM internal state machine and a Detected value that reports the situation with the external reference inputs signals. Finally,

the validity of the leap second file needed to perform the conversion from UTC (NTP timescale) to TAI (PTP timescale) is detailed in the panel. A detailed explanation of the parameters is provided below:

OID	Name	Value Type	Description
3.7120.x	gm/info/xxx		Specific information about the state of GM timing source.
3.7120.0	Message	<String>	User friendly message that summarizes the current state of the GM timing source.
3.7120.2	PPS Detected	<ul style="list-style-type: none"> • NONE • PPS (Only) • CLK (Only) • PPS & CLK 	Report the detection of external reference input on the front panel.
3.7120.4	Leap Second File Expiration Date	<String>	Expiration date of the leap seconds files. If there is more than one file, this will show the date that is further in the future. The date format is YYYY-MM-DD HH:MM:SS.
3.7120.5	Leap Second File Validity	<Bool> <ul style="list-style-type: none"> • No • Yes 	"Yes" if the leap seconds file is valid. "No" if it is expired or missing. See "Update Leap Seconds File" on page 87 for updating this file.

5.6 NTP

This section is about the configuration and monitorization related to the NTP protocol.



Note: Periodic pooling of NTP offset: In the current version of WRZ-OS it is recommended to set the NTP server in every node of the topology, either GM or BC, to check the coherence of the timing reference.

5.6.1 Configuration

5.6.1.1 NTP Provider

The WRZ-OS allow the device to provide its time through NTP on the management interfaces using the following parameters:

OID	Name	Value Type	Description
3.7005.x	ntp/cfg/provider/xxx		Configuration on how to provides NTP to 3rd party devices.

OID	Name	Value Type	Description
3.7005.1	Enabled	<Boolean> • YES • NO	If 'Yes' the device will act as an NTP server on its management interfaces to distribute its own Time of Day to other devices.
3.7005.4	Stratum Mode	• Auto • Manual	Mode to provide the NTP stratum. If Manual it will directly set the value from 'Manual Stratum', otherwise it will take into account the virtual clock quality (timing source, clock accuracy, etc.) to modify this value.
3.7005.7	Manual Stratum	• Stratum 1 • Stratum 2 • Stratum 3 • Stratum 3E • Stratum 4 • Stratum 4E • Stratum 15	Manually force the Stratum announced by the NTP server. See "Stratum Levels" on the facing page for more information



Caution: Reboot to apply NTP provider parameter: Many of the settings to configure the NTP server are only loaded during initialization of the device and thus a reboot might be needed in order to apply them.

5.6.1.2 NTP Timing Source Configuration

The configuration of an NTP timing source is divided in two parts. The first panel provides the configuration shared by all the NTP timing sources:

OID	Name	Value Type	Description
3.7001.x	ntp/cfg/xxx		Configuration on how to provides NTP to 3rd party devices..
3.7001.2	Refresh Rate	<Integer> • Default: 30	Time lapse between NTP server queries (in seconds).
3.7001.3	Retries	<Integer> • Default: 5	Number of retries for NTP server queries performed at the initialization of the device.

The second panel is a table where each column represents an NTP timing source:

OID	Name	Value Type	Description
3.70x0.x	ntp/x/cfg/xxx		Configuration of the <u>x</u> NTP timing source (x=[1-5]).
3.70x0.0	IPv4 Server	<String>	IP or URL of the reference NTP server.



Note: NTP Passive Timing Source: Due to its poor performance NTP timing sources are always forced to be “Passive Only”. However, adding them to the configuration will provide a more robust solution as they can be used to cross-validate the active timing source.

5.6.2 Info/Overview

This panel provides an overview of the status for each NTP instance:

OID	Name	Value Type	Description
3.70x5.x	ntp/x/info/xxx		Information of the <u>x</u>th NTP timing source (x=[1-5]).
3.70x5.1	Server Status	<ul style="list-style-type: none"> • Disabled • OK • NTP sync error • NTP stopped replying 	NTP server status. Warns if the NTP server cannot be reached.
3.70x5.0	Offset	<Integer>	Time offset between the device and the NTP reference server (in seconds).
3.70x5.2	Stratum	<ul style="list-style-type: none"> • Stratum 0 • Stratum 1 • Stratum 2 • Stratum 3 • Stratum 4 • Stratum 15 • Undefined 	Stratum announced by the corresponding NTP server.

5.6.3 Stratum Levels

The NTP stratum is a measure for synchronization distance from the reference clock which might not always reflect the timing performance such as jitter or delay. In other words, a server synchronized to a stratum (n) server will be running at stratum (n+1) where the upper limit for stratum is 15.

- » Stratum 0: Corresponds to the reference clock sources that relays Coordinated Universal Time (UTC). Stratum 0 servers should only be deployed within a metrology institute and must not be available on the internet.
- » Stratum 1: Corresponds to the servers that are directly synchronized to stratum 0. They can also be considered a Primary Reference Source (PRS) such as calibrated GNSS receiver or Atomic Clocks. The Grand-Master node is typically connected to an external reference that provides NTP with Stratum 1.
- » Stratum 2: They are synchronized by a stratum 1 clock. It is the default stratum level when NTP provider is set in manual mode.
- » Stratum 3: They are synchronized by a stratum 2 clock.

- » Stratum 4 and below: Devices that announce this level should only be used for cross-validation or backup but not as the primary NTP reference to synchronize a 3rd party device.
- » Stratum 15: It is the last valid stratum level defined by the NTP protocol.
- » Stratum 16: It is commonly used to indicate that the device is not synchronized and thus does not provide any valid NTP time.

5.7 Holdover

The WR-ZEN can be ordered with an optional holdover oscillator (OCXO) in order to ensure an accuracy of 1.5 μ s even after 24 hours.

If this holdover oscillator is detected, it will be automatically enabled as a timing source. Otherwise, when UNAVAILABLE, the device will announce itself directly as Free-running with UNKNOWN accuracy.

When the holdover is detected and enabled it can go through the following states:

1. **Locking:** During a minimum amount of time the holdover needs to perform a rough and quick learning on a stable clock reference before using it.
2. **Learning:** In order to maintain the best accuracy during enough time the holdover is learning about its environment using adaptive algorithms. This learning period has been set to 3 days in order to ensure to fulfill the accuracy specifications.
 - » If the holdover is triggered before this learning time, it will directly enter the expired state.
3. **Ready:** Once the HO has learned enough time to ensure good performance, the HO will be ready to be triggered at any moment (it will continue learning to slightly improve its performance).
4. **Activated:** The holdover has been triggered (by trigger_origin) and it is actually being the active timing source of the device. The clock info will be modified accordingly and announced to the timing network.
5. **Expired:** Reaching the holdover expired state means that the device announce itself with a Free-Running clock_class and a clock_accuracy to UNKNOWN. This also means that the corresponding VSC code is CRITICAL and thus if a better timing source is detected it will switch to this one. Worth mentioning that during the expired state, the holdover timing source is using the OCXO oscillator that provides better performance than the internal onboard oscillator.



Note: Holdover and FOCA: As mentioned above FOCA only switches between timing source when a failure is detected. This mean that if the active timing source of a device is HO, it will stick to it until reaching the expired states (Failure state of HO).



Note: GNSS reference to discipline the HO: The holdover adaptive algorithms have been optimized to learn from a GNSS reference clock (GPS L1 signals). A better clock can be used as reference (e.g., Atomic Clock, ePRTC, multi bands/constellations GNSS receiver) but using a clock reference with worth performance might not fulfil the provided specifications.

5.7.1 Configuration

The configuration of the holdover is easy and can be leaved untouched. However, depending on the user needs and the boundaries for timing accuracy, the Time to expired value should be adjusted to meet its specifications.

OID	Name	Value Type	Description
3.7210.x	holdover/cfg/xxx		Configuration for the Holdover if available
3.7210.0	Source Rank	<Integer> Default: 0	Source rank of the holdover as timing source. If leaved at zero it will be always placed as the last timing source. Then the user can allow to trigger the holdover between W
3.7210.1	Time to expire	<Integer> Default: 79800	Time until the holdover is considered out of specification and expired (default ~24h)
3.7210.2	Force Trigger	<Enum> 0. STOP 1. START 2. NONE	Force to manually trigger the holdover (START) or to expire it (STOP) without waiting the expiration timer. NONE, does nothing.



Note: HO in between timing source: Using the source rank the HO can be placed between two timing sources. For example, the user can use WR as primary timing source, HO as secondary and PTP 8265.1 as third one. This means that if WR fails, the device will enter in HO until expiration and finally switch to PTP that might provide better accuracy than an expired HO.

5.7.2 Info/Overview

An overview of the holdover timing source is provided to monitorize its state at any time as shown in "[Holdover overview meanwhile learning](#)" below.

If its state is UNAVAILABLE this means that the holdover oscillator has not been detected and its related information is irrelevant. If you have ordered the holdover option but the device does not detect it, please contact "[Technical Support](#)" on page 153.

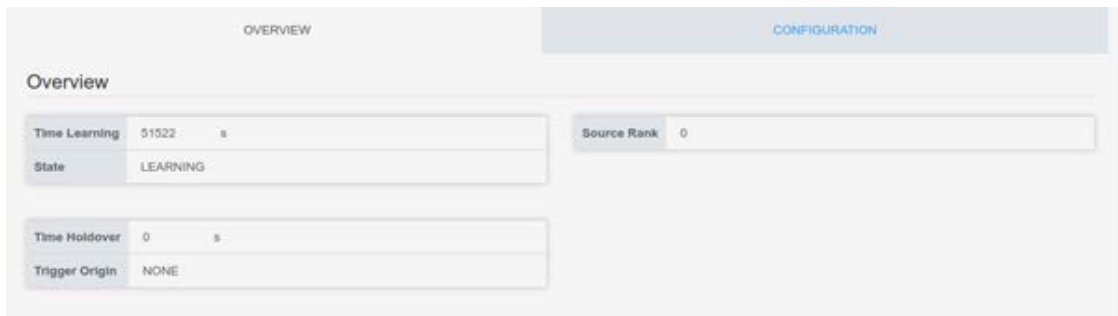

Figure 5-20: Holdover overview meanwhile learning

OID	Name	Value Type	Description
3.7220.x	holdover/info/xxx		Information about the Holdover timing source
3.7220.2	State	<Enum> 0. UNAVAILABLE 1. DISABLED 2. LOCKING 3. LEARNING 4. READY 5. ACTIVATED 6. EXPIRED	Current state of the holdover timing source as explained in the introduction of the section. If the holdover is not detected the corresponding state is UNAVAILABLE. The user can also manually force it as DISABLED in case to avoid triggered it.
3.7220.0	Time Learning	<Integer>	Time the holdover has been in LEARNING state (in seconds)
3.7220.1	Time Holdover	<Integer>	Seconds elapsed since holdover activation
3.7220.2	Trigger Origin	<Enum> • NONE • MANUAL • PPS_DRIFT • TRACK_LOST • LINKDOWN • EXTCLK_DOWN • EXTPSS_DOWN • CLK_DRIFT	Trigger origin of last one launched



Note: Holdover and FOCA: As mentioned above FOCA only switches between timing source when a failure is detected. This means that if the active timing source of a device is HO, it will stick to it until reaching the expired states (Failure state of HO).

5.8 Miscellaneous

This section allows to configure various settings that do not fit in any previous categories. The parameters can be seen below:

OID	Name	Value Type	Description
3.8010.x	misc/cfg/xxx		Miscellaneous Timing configuration.
3.8010.0	Time Zone	<String>	Configure the device time zone such that local time is properly displayed (web interface, LCD screen).
3.8010.0	PPS Mode	<ul style="list-style-type: none"> • Always ON • Only Locked • Legacy 	Configurable mode to control the PPS output where: <ul style="list-style-type: none"> - PPS is always output even if CRITICAL (Always ON). - PPS is only output if the active reference is locked. - PPS follows the same behavior as in the legacy release (wr-zynq-os-v2.x).
3.8020.x	misc/info/xxx		Miscellaneous Timing information.
3.8020.1	Uptime	<Integer> (u64)	Time Manager uptime in seconds.

5.8.1 Update Leap Seconds File

Besides using 10MHz & PPS signals from the front-panel, the GM time source needs to obtain the Time of Day (ToD) from an external reference. NTP is commonly used because of its easy configuration. However, the leap seconds must be properly handled. Indeed, NTP is based on UTC timescale whereas PTP is based on TAI and thus the non-fixed offset between UTC-TAI is provided by the leap second file which varies according to earth rotation.

This file (also known as Bulletin C) is published by the International Earth Rotation and Reference Systems Service (IERS) every six months to tell if a leap second jump is scheduled for the end of next June or December, or not. This also means that the file shipped within the release has an expiration date and does not guarantee a valid UTC-TAI conversion after this date.

In order to always ensure a correct UTC-TAI correction, the device that can act as Grand-Master on the network, can also manually update this file through the Misc. panel:

Update Leap Seconds

Leap-seconds files are only valid during 1 years, to keep the device updated download the latest one from <https://www.ietf.org/timezones/data/leap-seconds.list>

Drag & drop files here ...

Figure 5-21: Manual Leap seconds update.

Security & Authentication

The WR-ZEN incorporates several mechanisms in order to provide enhanced security to the system. TACACS+ and RADIUS are integrated to enable remote authentication for network access control through a centralized server. Additionally, the secure version of the network protocols used in the system are implemented, i.e. SCP, HTTPS, SNMPv3, and a firewall is included to provide a robust system against malicious users.

The following topics are included in this Chapter:

6.1 Upload SSH keys	90
6.2 HTTPS	90
6.3 TACACS+	93
6.4 RADIUS	95
6.5 Firewall	98

6.1 Upload SSH keys

The first time a device is accessed via SSH by a host, its IP should be added to the known hosts list as illustrated below. Then the password corresponding to the root user will be asked (default password is 'root' as detailed in "[Default Configuration](#)" on page 26).

```
ssh root@192.168.7.25
```

```
The authenticity of host '192.168.7.35 (192.168.7.35)' can't be estab-
lished.          ECDSA          key          fingerprint          is
SHA256:YgGTNfRPHYH4ekrJxDShK7D7PiD+1lHUy7dv+7460dSs.
```

```
Are you sure you want to continue connecting (yes/no)? Yes
```

```
Warning: Permanently added '192.168.7.25' (ECDSA) to the list of known
hosts.
```

```
Welcome to WR-ZEN
```

```
wr-zynq-os version: v3.2-RC1
```

```
root@zen-425:~#
```

This authentication procedure will only need to be confirmed the first time and will not be asked in the later connections.

```
ssh root@192.168.7.25
```

```
Welcome to WR-ZEN
```

```
wr-zynq-os version: v3.2-RC1
```

```
root@zen-425:~#
```

In order to improve security, it is strongly recommended to upload your public key to the device instead of using a password. This can easily be done by running the command:

```
ssh-copy-id root@<device_ip>
```

This setting is also available in the Expert mode of the GUI under Security > Authentication > SSH public key only (disable password). Choose Yes in the field, Save, and Reboot your device to activate changes.

6.2 HTTPS

Hypertext Transfer Protocol over TLS (HTTPS) is the encapsulation of HTTP over a Transport Layer Security (TLS) secured channel, which is the primary protocol used to send data between a web browser and a website.

The WR-ZEN includes the possibility of activating HTTPS. This can be done from the web interface by following the next steps:

The options about HTTPS can be accessed under: Security > HTTP/HTTPS as shown in the figure below:

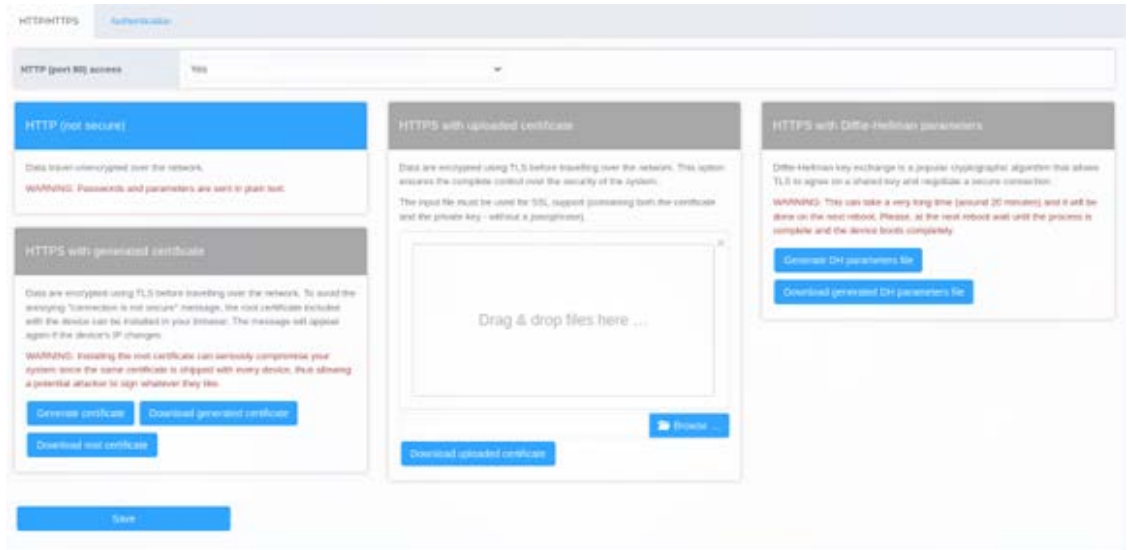

Figure 6-1: Security-HTTP/HTTPS menu of Web Interface.

The option selected by default is HTTP. While this option is active, the contents are transmitted in plain text.

In order to use the secure mode, it is necessary to either use an already-existing certificate or generate a new one.

By using the second window of the HTTPS menu as shown below, it is possible to first generate a certificate and then download it.

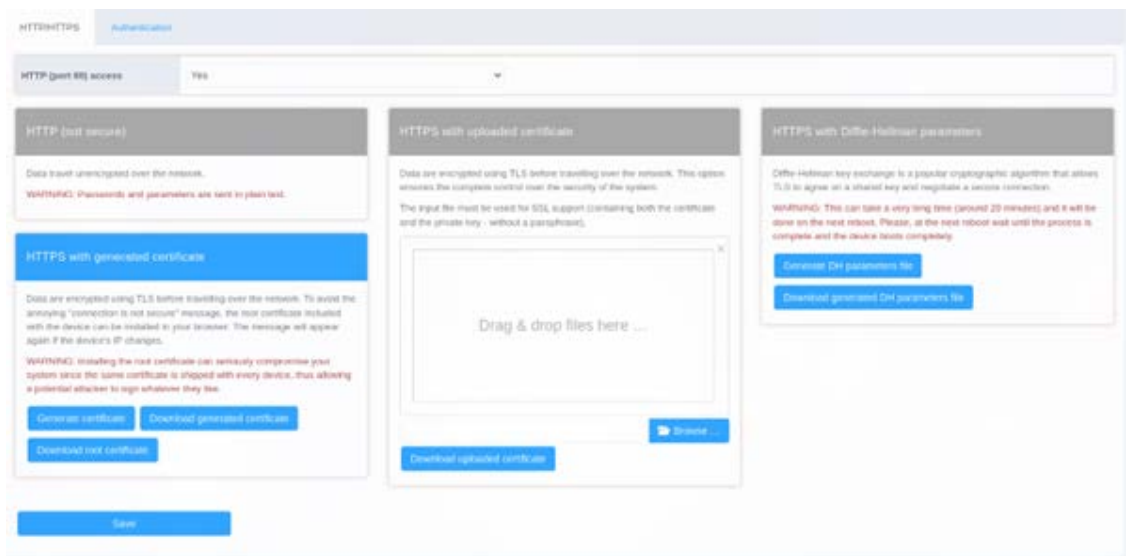

Figure 6-2: Using HTTPS with generated certificate.

The third panel of the HTTP/HTTPS menu allows to upload a certificate from your PC and run HTTPS using that certificate.

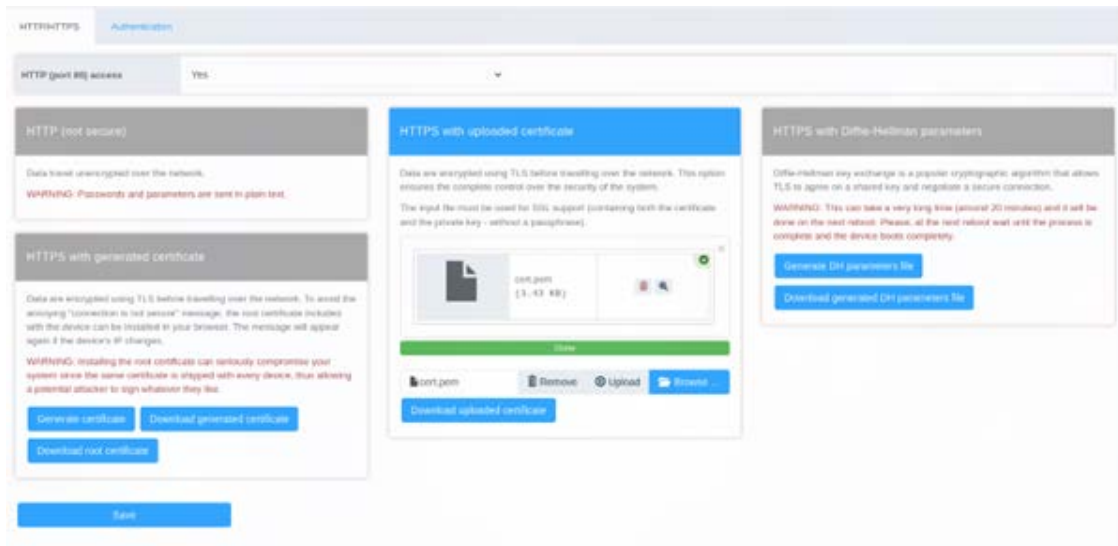

Figure 6-3: Using HTTPS with uploaded certificate.



Caution: Once the secure mode has been activated, an info message will be shown advising that the next connection will be done on HTTPS. After rebooting the device, the HTTP port will be redirected to HTTPS. There is a possibility to completely disable port 80, but be careful because if HTTPS is not configured, the web access will be lost and the only way to enable it again will be using CLI.

Finally, the fourth panel of the HTTP/HTTPS menu enables Diffie-Hellman parameters in the TLS key exchange. This is optional but recommended. There are two buttons to generate and download the DH parameters file.



Caution: Diffie-Hellman generation time: To generate the Diffie-Hellman parameters file, it is required to reboot the device and wait up to 20 minutes, or even more in some particular cases. In this period, the device **MUST NOT** be powered off, rebooted or any similar action. The device will not be accessible until this process finishes.

6.3 TACACS+

TACACS+ (Terminal Access Controller Access Control Server) is a security protocol for AAA (Authorization, authentication and accounting), which is used to provide centralised authentication for users who want to gain access to the network.

This section explains how to install and configure a TACACS+ on up to two servers on a Linux environment where the client is a WR-ZEN device.

The instructions to install and configure a TACACS+ server on an Ubuntu machine are explained in the Appendix "[TACACS+ and RADIUS server configuration](#)" on page 162.

In order to configure the TACACS+ protocol, it is necessary to modify the configuration file usually located at:

```
/etc/tacacs+/tac_plus.conf
```

6.3.1 Verification of TACACS+ installation

In order to verify the installation, it is possible to use the following set-up (see figure below). The TACACS+ client will ask for authentication to the server, which will answer if the user passed. Then the device will ask for credentials, which will be validated by the TACACS+ server and grant access to the user if the authentication was successful.

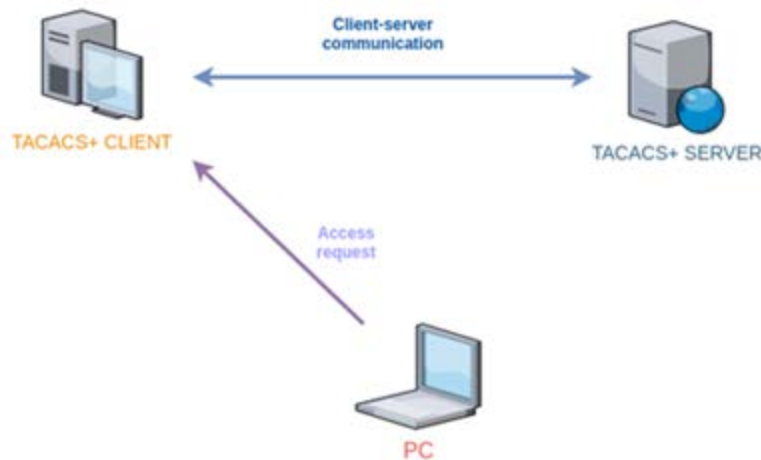

Figure 6-4: TACACS setup for verifying the installation.

6.3.2 TACACS+ Client configuration

Once the server is configured, it is necessary to configure the client. In this section, the client will be configured on the WR-ZEN device. For that purpose, gpa_ctrl is used to configure IP and secret. These parameters can be found in the security module:

```
root@zen-305:~# gpa_ctrl -s security auth/tacacs/server1_ip
172.17.5.39
```

```
root@zen-305:~# gpa_ctrl -s security auth/tacacs/server1_secret sev-
ensecret
```

And reboot to apply the changes.

Then the client can be accessed by using the configured user and password. In order to get debug messages from TACACS+, the service can be launched with the command `tac_plus-g`, always indicating the configuration file. For example, in the screenshots of figure a successful access with the TACACS+ password the first time, failed the second time and succeeded the third. Below you can see the verbose `tac_plus` output.

```
root@wrztpfl-417:~# Connection to 192.168.1.145 closed.
→ ~ ssh tacuser1@192.168.1.145
Password:
Last login: Fri Jun 10 04:47:03 CEST 2022 from 192.168.1.181 on ssh
Welcome to WR ZEN TP-FL
wr-zynq-os version: v3.3
*****
* WARNING: We recommend you change the default password for the *
* 'root' user immediately. *
* You can do it by executing passwd (with option -a sha512) *
* or using the Web interface. *
*****
root@wrztpfl-417:~# Connection to 192.168.1.145 closed.
→ ~ ssh tacuser1@192.168.1.145
Password:
Password:
Last login: Fri Jun 10 04:47:16 CEST 2022 from 192.168.1.181 on ssh
Welcome to WR ZEN TP-FL
wr-zynq-os version: v3.3
*****
* WARNING: We recommend you change the default password for the *
* 'root' user immediately. *
* You can do it by executing passwd (with option -a sha512) *
* or using the Web interface. *
*****
root@wrztpfl-417:~#
```

Figure 6-5: SSH connection with the WR-ZEN board

```
root@fbc1081a5dc0f:/# /usr/sbin/tac_plus -C /etc/tacacs+/tac_plus.conf -g
Reading config
Version F4.0.4.27a Initialized 1
socket FD 3 AF 2
uid=0 euid=0 gid=0 egid=0 s=531977040
connect from 192.168.1.145 [192.168.1.145]
connect from 192.168.1.145 [192.168.1.145]
login failure: tacuser1 192.168.1.145 (192.168.1.145) ssh
connect from 192.168.1.145 [192.168.1.145]
```

Figure 6-6: tac_plus output with debug information



Caution: When TACACS and RADIUS work and have been configured on the same client device, be careful with the order of the configuration lines in `/etc/pam.d/sshd`. The TACACS configuration line must be added always in first place and after it, the RADIUS configuration line. This is because when the RADIUS configuration is the first line, authentication of the first password always goes to the RADIUS server and, if it is the password of TACACS, the authentication will fail. With TACACS configuration in first line, the first password is verified with both TACACS and RADIUS.

6.4 RADIUS

RADIUS (Remote Authentication Dial In User Service) is a security protocol for AAA (Authorization, authentication and accounting), which is used to provide centralized authentication for users who want to gain access to the network.

This section will define the processes necessary to install and configure the RADIUS client on up to two servers on the WR-ZEN device.

The steps to install and configure a RADIUS server on an Ubuntu machine are explained in Appendix "TACACS+ and RADIUS server configuration" on page 162.

6.4.1 RADIUS configuration files

The different existing configuration files to modify the operation of the protocol are:

- » **radiusd.conf:** Contains protocol configuration parameters.
- » **users:** Contains users and access passwords.
- » **clients.conf:** Contains the list of clients that are allowed to make requests to the RADIUS server.
- » **templates.conf:** The goal is to have a common configuration located in this file and list only the differences in the individual sections. This feature is more useful for sections such as "customers."
- » **trigger.conf:** Used to set triggers for snmptrap.
- » **proxy.conf:** RADIUS proxy and configuration directives.
- » **policy.d:** Configuration files for policies of acceptance, rejection, filter, etc. of requests

6.4.2 Verification of RADIUS installation

In order to verify the installation, the following set-up is configured (Figure). When a user authenticates a device, this device will send a message to the RADIUS server, which will accept or reject the user depending on if this device is taken as a client for this server.

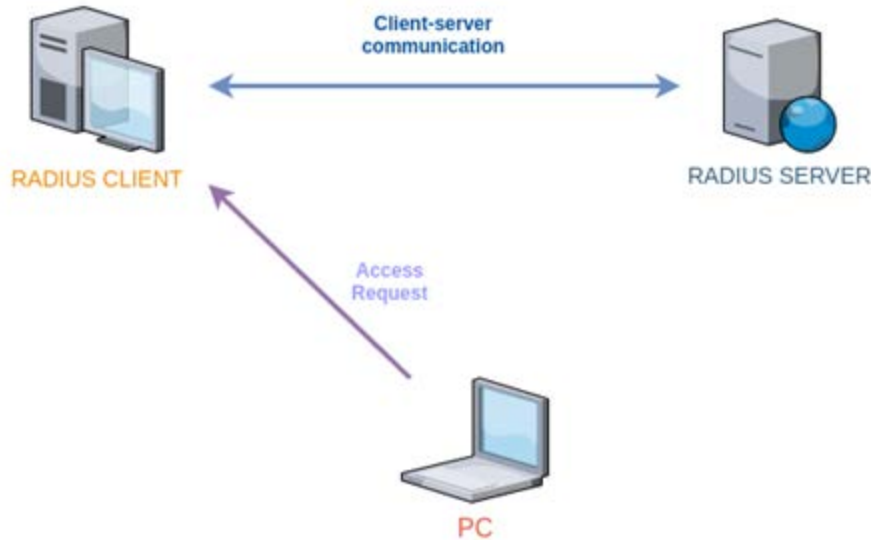

Figure 6-7: Set-up RADIUS for verifying the installation

6.4.3 RADIUS client configuration

Once the server is configured, the client must be configured as well. This section explains how to do it on the WR-ZEN.

The use of `gpa_ctrl` allows to configure ip and secret. These parameters can be found in security module:

```
root@zen-305:~# gpa_ctrl -s security auth/radius/server1_ip 172.17.5.39
```

```
root@zen-305:~# gpa_ctrl -s security auth/radius/server1_secret sev-ensecret
```

And reboot to apply the changes.

Now that everything has been configured correctly, it is possible to access the WR-ZEN board with these new passwords which have been set in the users file. In addition, the command `freeradius-X` can be used in order to verbose the RADIUS access.

The following figure shows an access using the password that was configured in the users file, but failing the first try. Looking at the output of `freeradius` at the host, it is possible to get the information from the first failed attempt:

```

→ ~ ssh raduser1@192.168.1.145
Password:
Password:
Last login: Fri Jun 10 04:47:54 CEST 2022 from 192.168.1.181 on ssh
Welcome to WR ZEN TP-FL
wr-zynq-os version: v3.3
*****
* WARNING: We recommend you change the default password for the *
* 'root' user immediately. *
* You can do it by executing passwd (with option -a sha512) *
* or using the Web interface. *
*****
root@wrztpfl-417:~# █
    
```

Figure 6-8: SSH connection with the WR-ZEN board

```

Ready to process requests
(O) Received Access-Request Id 244 from 192.168.1.145:34406 to 192.168.176.2:1812 length 93
(O) User-Name = "raduser1"
(O) User-Password = "root"
(O) NAS-IP-Address = 127.0.1.1
(O) NAS-Identifier = "sshd"
(O) NAS-Port = 17098
(O) NAS-Port-Type = Virtual
(O) Service-Type = Authenticate-Only
(O) Calling-Station-Id = "192.168.1.181"
(O) # Executing section authorize from file /etc/freeradius/3.0/sites-enabled/default
(O) authorize {
(O) policy filter_username {
(O) if ($User-Name) {
(O) if ($User-Name) -> TRUE
(O) if ($User-Name) {
(O) if ($User-Name =~ / /) {
(O) if ($User-Name =~ / /) -> FALSE
(O) if ($User-Name =~ /B[0]+B/ ) {
(O) if ($User-Name =~ /B[0]+B/ ) -> FALSE
(O) if ($User-Name =~ /\.\/) {
(O) if ($User-Name =~ /\.\/) -> FALSE
(O) if (($User-Name =~ /B/) && ($User-Name !~ /B(.+)\.(.+)$/) ) {
(O) if (($User-Name =~ /B/) && ($User-Name !~ /B(.+)\.(.+)$/) ) -> FALSE
(O) if ($User-Name =~ /\.\/) {
(O) if ($User-Name =~ /\.\/) -> FALSE
(O) if ($User-Name =~ /B\/) {
(O) if ($User-Name =~ /B\/) -> FALSE
(O) } # if ($User-Name) = notfound
(O) } # policy filter_username = notfound
(O) [preprocess] = ok
(O) [chap] = noop
(O) [mschap] = noop
(O) [digest] = noop
(O) suffix: Checking for suffix after "B"
(O) suffix: No 'B' in User-Name = "raduser1", looking up realm NULL
(O) suffix: No such realm "NULL"
(O) [suffix] = noop
(O) eap: No EAP-Message, not doing EAP
(O) [eap] = noop
(O) files: users: Matched entry raduser1 at line 34
(O) [files] = ok
(O) [expiration] = noop
(O) [logintime] = noop
(O) [pap] = updated
(O) } # authorize = updated
(O) Found Auth-Type = PAP
(O) # Executing group from file /etc/freeradius/3.0/sites-enabled/default
(O) Auth-Type PAP {
(O) pap: Login attempt with password
(O) pap: Comparing with "known good" Cleartext-Password
(O) pap: ERROR: Cleartext password does not match "known good" password
(O) pap: Passwords don't match
(O) [pap] = reject
(O) } # Auth-Type PAP = reject
(O) Failed to authenticate the user
    
```

Figure 6-9: Freeradius failed attempt with debug information



Caution: When TACACS and RADIUS work and have been configured on the same client device, be careful with the order of the configuration lines in `/etc/pam.d/sshd`. The TACACS configuration line must be added always in first place and after it, the RADIUS configuration line. This is because when the RADIUS configuration is the first line, authentication of the first password always goes to the RADIUS server and, if is the password of TACACS, the authentication will fail. With TACACS configuration in first line, the first password is verified with both TACACS and RADIUS.

6.5 Firewall

The WRZ-OS is shipped with the standard iptable firewall that came in most of the Linux distribution.

The default rules applied is to forbid everything in the timing network (the optical fiber interface named `wrX`) so that only the necessary services can be accessed. The table below resume the port that can be accessed:

Table 6-1: Default firewall configuration

Timing (wrX)	
Service	Port
DNS	53
DHCP/BootP	67-68
NTP	123
PTP/WR	319-320

If an advanced user needs to customize the access to meet a specific security policy, he can use the persistent custom files ("[Persistent Custom Files](#)" on page 159) to overwrite the default rules with its own configuration.

6.5.1 Example to only allow a specific IP for management

This is a typical use case where only a single IP (or a subnetwork) should be allowed to access to the management port of the device.

```
##First append the current rule to existing rule (otherwise flush)
iptables -A INPUT -i eth0 -s 192.168.7.1 -j ACCEPT
iptables -A INPUT -i eth0 -j DROP
iptables -A INPUT -i eth1 -s 192.168.7.1 -j ACCEPT
iptables -A INPUT -i eth1 -j DROP
```

```
## Then save to local file so that this configuration is applied at  
next reboot
```

```
iptables-save > /usr/local/etc/iptables.rules
```



Note: It is not recommended to edit the iptable files without any local access (UART) to the device as it is easy to make an error and fully block the network access to this device. To revert the changes, the user should perform a factory reset or delete the /usr/local/etc/iptables.rules files.

BLANK PAGE.

Monitoring & Logging

The WR-ZEN device includes enhanced monitoring and logging tools to ease its deployment and manageability during operation.

The following topics are included in this Chapter:

7.1 Syslog	102
7.2 SNMP	105
7.3 LLDP	115
7.4 Healthing	120
7.5 LCD screen menu	123
7.6 External monitoring tool	129

7.1 Syslog

Syslog is a standard for message logging. It allows separating the software that generates messages, the system that stores them, and the software that reports and analyzes them. The aim of logging is to collect all the system information and make it easily accessible for the user. Kernel events, changes in the state of the device or user actions are sometimes useful information in terms of debugging or monitoring. Information about the state of the device in the past or a value of a given parameter in a certain time could be critical to find out the reason of a specific behavior of the device.

There are three different types of logging depending on the persistence:

- » **Session logs:** These logs are initialized at boot time and are lost when the device is powered off. They are usually saved in a reserved directory `/var/log`.
- » **Permanent logs:** These logs are kept between reboots, giving information about the state of the device before it was restarted. These kinds of logs help to find out the reasons of the last reboot or if there is something preventing the device from start.
- » **Remote logs:** They are saved remotely via rsyslog. It is necessary to set-up at least one external server for this purpose (max 2).

7.1.1 Session logs

During the operation of the device a log recording is performed, saving the information in different local files. These files are normally saved at `/var/log`, and have the following content:

- » **auth.log:** It contains all the accesses or connections to the device through SSH (Secure Shell), serial port, web interface,...
- » **boot.log:** It contains the boot information from a userspace perspective.
- » **boot-procedure.log:** It contains the boot information from a kernel perspective.
- » **wproc-child-xxx.log(*):** These files contain the log of the module with the corresponding ID (100 -> wr0, 101 -> wr1, ..., 148 -> eth0, 149 -> eth1).
- » **secure:** It contains the security logging.
- » **systemlog:** It contains the kernel/user event logging.

Systemlog

In the same way as a normal Linux device, the kernel and the userspace processes send information to a central logger. Its contents can be found at `/var/log/systemlog` and it centralizes all logs in a unique file via syslog.

The log entries have the following format:

```
May 28 06:19:06 zen-425 root: healthingd#W:
```



```
_gpa_prm_call_trigger_on_warning:852:
```

```
'(2.1002.2)alert/timing_state' changes to a warning value: Warning
```

As can be seen, the log event is divided in the following parts:

- » **Timestamp:** It shows the date and time of the event information
- » **DevID:** It shows the device identification (hostname)
- » **Facility/Level:** It shows the type of program which is logging
- » **Module:** It shows the name of the internal module that generated the logging
- » **Message:** It shows information about the event

7.1.2 Permanent logs

The devices keep a permanent log to maintain the system information in case of unexpected reboots. This information is saved during the reboot process and can be found at `/root/.log/reboot/`.

- » `.last_reboot:` It contains the timestamp of the last reboot
- » `wrz-xxx-xxx-xxxx-xxx.logdump:` It contains the output of the `wrz_logdump` at the moment of the reboot

7.1.3 Remote logs

The devices can be configured to forward the system log information to a remote centralized server. This server needs to be configured by the user so it supports rsyslog. Saving information into the device normally is not practical for huge deployments, so it is recommended to set-up a rsyslog server and store the logging in a different machine, centralizing the logging for all devices in the deployment. The device can connect to up to 2 servers for this purpose, listed as Server 1 and Server 2.

7.1.4 Logging tools

By default, the device uses three tools to manage the internal logging tasks:

Collectd

Collectd is a program which runs in background collecting some metrics about the system and applications performance. These measures are saved in the RRD format, which can be used as input of rrdtools.

RRD databases can be found at `/var/lib/collectd/rrd/<hostname>` and include information about the CPU, the management interfaces, the memory, etc.

Logdump

The wrz_logdump tool is responsible of generating the logdump. The logdump is a set of compressed files that can be easily shareable, which provides all the information about the current state and log of the device.

The logdump can be generated and downloaded from the web GUI under the Management > Misc > Dumplog tab or from the CLI executing the following command:

```
wrz_logdump -a -o /root/
```

The wrz_logdump contains different files that are useful to debug problems including the following information:

- » The content of /boot and /media partitions including information about the software
- » The main configuration from the /root/.config file
- » Information about the interfaces, IP addresses, netmask, packets, status, etc
- » Information about interrupts from the HW
- » Information related with memory status
- » The systemlog file under /var/log/systemlog
- » Collectd databases
- » Information about uboot and versions



Note: The Orolia support service will require the wrz_logdump information in order to debug any issues. Please, download and attach this information when opening a support ticket.

All the logging information under /var/log/ is rotated for security reasons. This prevents to use all the available memory in the device in case the log files suddenly increase and is performed automatically when the file size exceeds 5 MB.



Note: Log rotation only affects the files with extension .log. Other files contained in /var/log/ folder are not affected.

7.1.5 Configuration

The logging configuration can be performed through the wrz_config tool in the CLI. Once the tool is launched, the logging configuration parameters can be found under Management > Logging.

```

*** Logging configuration parameters ***
(192.168.7.1) server_ip
(514) server_port
    protocol (UDP) --->
    verbose_all (Disable) --->
    log_autosave (disabled) --->
(5) log_n_rotate (NEW)
    
```

Figure 7-1: Logging configuration parameters through CLI.

The logging sub-tree is located under Misc. section and contains the following parameters:

OID	Name	Value Type	Description
13.2000.1	Server IP	<IP address> (i.e., 192.168.1.5)	IP address from the remote logging server.
13.2000.2	Server port	<Integer> (i.e., 514)	Port information from the remote logging server.
13.2000.3	Protocol	<Enum> • UDP • TCP	Communication protocol for remote logging between the device and the server.
13.2000.4	Verbose all	<Enum> • Disabled • Enabled	High verbosity logging configuration for modules and log information.
13.2000.5	Log autosave	<Enum> • Disabled • Enabled	Automatic permanent logging backup in the directory /root/.log with a periodicity of 6 hours in case of power cuts.
13.2000.6	Log N rotate	<Integer> (i.e., 5)	Number of logdumps rotations stored in the device.

7.2 SNMP

Simple Network Management Protocol (SNMP) is an application-layer protocol defined by the Internet Architecture Board (IAB) in RFC1157 for exchanging management information between network devices. It is a part of Transmission Control Protocol / Internet Protocol (TCP/IP) protocol suite.

SNMP is one of the widely accepted protocols to manage and monitor network elements. Most of the professional-grade network elements come with bundled SNMP agent. These agents must be enabled and configured to communicate with the network management system (NMS).

7.2.1 Configuration

In order to understand the SNMP configuration, it is important to enumerate the configuration files in the device:

- » `/wr/etc/snmp/SEVEN-PRODUCT-MIB.txt`: It contains the MIB file with all the SNMP OIDs in the device.
- » `/etc/snmp/snmpd.conf`: It contains the global SNMP configuration. This file can be modified to customize the configuration.
- » `/usr/share/snmp/snmpd.conf`: It contains the SNMP configuration managed by Seven Solutions software.
- » `/var/lib/snmp/snmpd.conf`: It contains the SNMPv3 persistent data.
- » `/var/log/snmp/gpa_passwd.log`: It contains the SNMPv3 user passwords change.



Note: SNMP file route: These files are located into `/media/data/usr/local/...` to make it persistent between reboots and firmware updates.



Caution: `/usr/share/snmp/snmpd.conf` modification: This file is automatically generated. Any manual changes will be lost when relaunching the SNMP daemon.

The SNMP parameters sub-tree is located under misc and is divided in three main parts. **SNMP, v1/v2, and v3:**

1. **SNMP:** General SNMP information.

OID	Name	Value Type	Description
13.3000.1	Location	<String> (i.e.,My location)	Name of the corresponding location.
13.3000.2	Contact	<String> (i.e.,user-@dom.com)	Contact information.

2. **v1/v2:** Parameters for SNMP v1 and v2.

OID	Name	Value Type	Description
13.3002.1	Community name	<String> (i.e., public)	Name of the community.

OID	Name	Value Type	Description
13.3002.2	Access view	<Enum> <ul style="list-style-type: none"> • none. • basic • extended • all 	Access view options. <ul style="list-style-type: none"> • none: Disable SNMP v1 and v2. • basic: Show basic SNMP information. • extended: Show extended SNMP information. • all: Show all the SNMP information
13.3002.3	Access mode	<Enum> <ul style="list-style-type: none"> • ro: Read only. • rw: Read/write 	Access mode options.
13.3002.4	Source mask (1-5)	<IP address> (i.e., 192.168.1.5 or 192.168.1.0/24)	IP addresses from hosts allowed to retrieve information from the device using SNMP v1 and v2 queries.



Note: In order to disable SNMP v1 and SNMP v2, the value none must be chosen for access_view.



Note: Source mask value: By default, the localhost source is added. If no other source mask is added the device will only accept local queries.



Caution: The default community name is public. For security reasons, it is recommended to change this parameter.



Caution: Access mode configuration: For security reasons, it is not recommended to provide read/write permissions while using SNMP v1 or v2.

3. **v3:** Parameters for SNMP v3 users and passwords (see table below).

OID	Name	Value Type	Description
13.3X10.1	User name	<String> (i.e., userSNMP)	Name of the SNMPv3 user.
13.3X10.2	Access view	<Enum> <ul style="list-style-type: none"> • none. • basic • extended • all 	Access view options. <ul style="list-style-type: none"> • none: Disable SNMP v1 and v2. • basic: Show basic SNMP information. • extended: Show extended SNMP information. • all: Show all the SNMP information
13.3X10.3	Access mode	<Enum> <ul style="list-style-type: none"> • ro: Read only. • rw: Read/write 	Access mode options.
13.3X10.4	Auth	<Enum> <ul style="list-style-type: none"> • MD5 • SHA 	Authentication encryption protocol.
13.3X10.5	Priv	<Enum> <ul style="list-style-type: none"> • DES • AES 	Privacy encryption protocol.

7.2.1.1 General configuration

In order to configure SNMP from the CLI, the `wrz_config` tool must be accessed. Once it has been launched, the SNMP configuration is under `Management > SNMP`.

```

*** SNMP configuration parameters ***
info --->
v1_v2 --->
v3 --->
traps --->

```

Figure 7-2: SNMP configuration.

Under the different tabs, all the described information in the previous tables or in the following sections can be accessed, modified, and saved.

On a different thread, the general commands to manage SNMP from a command line, e.g. **snmpget**, **snmpset**, **snmpwalk** or **snmpusm**, are available in the device. A detailed explanation about how to use them is out of the scope of this user guide, but multiple SNMP

tutorial guides can be found online. Additionally, the **gpa_ctrl** tool allows to visualize all the parameters in a quick view.

```
gpa_ctrl -A misc snmp
```

The access mode parameter defines if it is allowed to execute a query (snmpset) for remote configuration using SNMP. If the parameter is set to read/write, the device will accept the query. However, if it is configured as read only, an error message will appear claiming that there is no access granted.

The view mode parameter defines the visible SNMP parameters in the device. In all cases, a minimum configuration that allows to configure the user passwords is set. The definition of available information in each category is defined in the SNMP configuration files. By default, none disables the SNMP version while the other three categories (basic, extended, all) provide increasing insights from the device information.

In order to create custom SNMP groups, the configuration file `/usr/share/snmp/snmpd.conf` can be modified to define or modify them.



Caution: SNMP configuration files customization: Orolia is not responsible for any damage caused by the user while manually modifying the SNMP configuration files.

If it is needed to restore the default credentials in `/etc/snmp/snmpd.conf` and `/var/lib/snmp/snmpd.conf` the following command can be used:

```
/etc/init.d/snmpd force-reset
Are you sure you want to remove all persistent snmp files? [y/N] y
```



Note: SNMP credentials reset: The `snmpd force-reset` command recreates persistent files but maintains the SNMP parameters sub-tree configuration.

The information in `/usr/share/snmp/snmpd.conf` is recreated following the saved SNMP sub-tree configuration.

7.2.1.2 Specific SNMP v1/v2 configuration

Additional SNMP v1 and v2 communities can be created editing the `/etc/snmp/snmpd.conf` file adding the following line:

```
rocommunity <community_name>
```

After modifying the file, restart the SNMP daemon to load the changes.

Alternatively, the groups definition can be modified to create and add communities. For that purpose, the information from the mapping section in `/usr/share/snmp/snmpd.conf` can be used as a reference to modify the `/etc/snmp/snmpd.conf` file.

7.2.1.3 Specific SNMPv3 configuration

By default, there are four created users in the device:

snmpv3 User	Auth Protocol	Priv Protoco	Auth Password (default)	Priv Password (default)
userSNMP	MD5	DES	userSNMPpass	userSNMPpass
adminSNMP	MD5	DES	adminSNMPpass	adminSNMPpass
secuserSNMP	SHA	AES	secuserSNMPpass	secuserSNMPpass
secadminSNMP	SHA	AES	secadminSNMPpass	secadminSNMPpass



Note: SNMP v3 user parameters: Only `access_view` and `access_mode` parameters can be directly changed. Encryption protocols are changed through `change_password`.



Note: SNMP v3 users: `UserSNMP` and `adminSNMP` are included for retro-compatibility purposes. It is recommended to use users relying on SHA and AES encryption.

In the case of SNMP v3 the default passwords can be modified using the parameters under the `change password` sub-tree:

OID	Name	Value Type	Description
13.3800.0	User name	<String> (i.e., userSNMP)	Name of the SNMPv3 user.
13.3800.1	Auth	<Enum> • MD5 • SHA	Authentication encryption protocol.
13.3800.2	Priv	<Enum> • DES • AES	Privacy encryption protocol.

OID	Name	Value Type	Description
13.3800.3	Old Auth Password	<String> (i.e.,oldPassword)	Old Authentication password.
13.3800.4	Old Priv Password	<String> (i.e.,oldPassword)	Old Privacy password.
13.3800.5	New Auth Password	<String> (i.e.,newPassword)	New Auth Password
13.3800.6	New Priv Password	<String> (i.e.,newPassword)	New Privacy password.
13.3800.7	Change now	<Enum> <ul style="list-style-type: none"> • N: No • Y: Yes 	Force the password change.

In order to create additional users in SNMPv3, the `/etc/snmp/snmpd.conf` can be modified using the `createUser` instruction:

```
createUser <user_name> <auth> <new_auth_password> <priv>
```

The `access_mode` for these users can be assigned as following:

```
<access_mode>user <user_name>
```

After saving the changes, the SNMP daemon must be restarted to apply them.

Alternatively, `net-snmp-create-v3-user` tool can be used after stopping the SNMP daemon or the groups definition can be modified to create users. For that purpose, the information from the mapping section in `/usr/share/snmp/snmpd.conf` can be used as a reference to modify the `/etc/snmp/snmpd.conf` file.

7.2.2 SNMP Traps

The SNMP traps are synchronous notifications generated by the agent which are sent to the manager. While in other SNMP communications, the manager actively requests information from the agent, the traps are sent from the agent to the manager without being explicitly requested. SNMP traps enable an agent to notify the management station of significant events by way of an unsolicited SNMP message. The SNMP traps include current `sysUpTime` value, an OID identifying the type of trap and optional variable bindings. A reference scenario where SNMP traps are used is shown below:

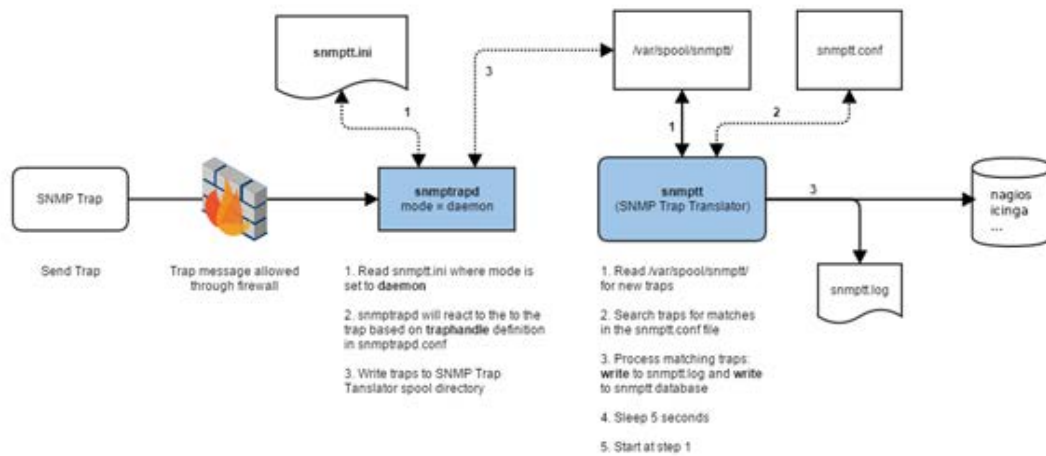

Figure 7-3: SNMP traps scheme.

Main parts:

- » **SNMP Trap:** The device sends a trap to a monitoring device; the traps are defined in a MIB file.
- » **snmptrapd:** It receives the SNMP trap and manages it.
- » **snmptt:** It translates the SNMP trap, classify the information with predefined clauses and acts accordingly to the rules defined for each SNMP trap type.
- » **Monitoring center:** Monitoring software, e.g. Nagios, Icinga, etc, that handles the traps using `snmptt`.



Note: The SNMP traps in this device are sent using SNMP v2, due to efficiency, security and simplicity reasons. All traps are sent with `snmpinform` that tries to confirm the reception of the trap by the Network Management System (NMS), and resends the trap until a timeout expires if it receives no confirmation.

7.2.2.1 Trap objects

The generated traps in the device contain different objects in order to provide general and specific information about the trigger of the notification.

- » `wrzTrapTime`: Contains the time information when the trap was sent.
- » `wrzTrapPrmOID`: Contains the OID information of the parameter associated to the generated trap.

- » wrzTrapPrmKey: Contains the full path parameter key associated to the generated trap.
- » wrzTrapPrmVal: Contains the value of the parameter that generated the trap as a number.
- » wrzTrapPrmValStr: Contains the value of the parameter that generated the trap as a string if existing.
- » wrzTrapModOID: Contains the OID information of the module associated to the generated trap.
- » wrzTrapModKey: Contains the module name associated to the generated trap.

The best way to review our traps definitions is read trap section in SEVEN-PRODUCT-MIB.txt file. You can find this file inside your device at /wr/etc/snmp/SEVEN-PRODUCT-MIB.txt.

7.2.2.2 Trap notifications

There are different events that trigger the generation of a trap in the device including startup, shutdown, module open or close and parameter status.

- » wrzInit: Trap generated when the system completely starts, and all services are initialized.
- » wrzShutdown: Trap generated when all services are closed before a system shutdown or reboot.
- » modOpen: Trap generated when a module or service is launched.
- » ModClose: Trap generated when a module or service is closed.
- » okagainParam: Trap generated when a parameter comes back to a correct status after an alert condition.
- » warningParam: Trap generated when a parameter changes to a warning status.
- » criticalParam: Trap generated when a parameter changes to a critical status.
- » outofrangeParam: Trap generated when a parameter goes to an out of range value.
- » TrackedParam: Trap generated when a tracked parameter changes its value.



Note: Trap definition: An extended definition of the traps can be found in the MIB file in /wr/etc/snmp/SEVEN-PRODUCT-MIB.txt



Note: Tracked parameters: A selection of parameters in the devices have been performed and flagged like tracked parameters. These parameters create an alert each time that their value is changed.

7.2.2.3 Trap configuration

The SNMP traps generated by the device can be configured using the traps sub-tree under snmp.

OID	Name	Value Type	Description
13.3900.1	Community name	<String> (i.e., public)	Name of the community.
13.3900.2-5	NMS IP 1-4	<IP address> (i.e., 192.168.1.5 or 192.168.1.0/24)	Authentication encryption protocolDestination NMS IP address.
13.3900.6	Start/shutdown	<Enum> • Enabled • Disabled	Enable/disable startup and shutdown traps.
13.3900.7	Modules Start/Close	<Enum> • Enabled • Disabled	Enable/disable module launch or close traps.
13.3900.8	Prms tracked	<Enum> • Enabled • Disabled	Enable/disable tracked parameters traps.
13.3900.9	Prms alert	<Enum> • Enabled • Disabled	Enable/disable traps when a parameter is in an alert status or back to a normal status.



Note: Default traps configuration: By default, all traps are enabled using the public SNMPv2 community for informative purposes.

7.2.2.4 Basic trap receptor NMS configuration

Install snmptrapd in the server receiving the SNMP traps:

```
sudo apt-get install snmptrapd
```

After installing `snmptrapd`, the configuration in `/etc/snmp/snmptrapd.conf` needs to be modified to authorize the reception of traps.

```
disableAuthorization                                     yes
traphandle default /<example>/snmp_trap_test_handle.sh
```

Once the configuration file has been modified, it is needed to edit the handle file for the received SNMP traps. For that purpose, it is important grant execution permissions to `snmp_trap_test_handle.sh`

```
#!/bin/sh
read host
read ip
vars=""
while read oid val; do
if [ "x$vars" = "x" ]; then
vars="$oid = $val"
else
vars="$vars, $oid = $val"
fi
done
echo trap: $1 $host $ip $vars
```

After this step, it is important to copy the MIB file from the device into the NMS.

```
sudo scp root@deviceip:/wr/etc/snmp/SEVEN- PRODUCT- MIB.txt /usr/share/snmp/mibs
```

Finally, the `snmptrapd` service must be stopped and re-run to view all the received traps.

```
sudo service snmptrapd stop
sudo snmptrapd -f -m all
```

7.3 LLDP

The WR-ZEN devices support the Link Layer Discovery Protocol (LLDP), which functions at the link layer (Layer 2 of OSI model) to discover neighboring devices and their capabilities.

7.3.1 Standard (IEEE 802.1AB-2005) TLVs

The WRZ-OS supports the mandatory and standard TLVs defined by the LLDP (IEEE 802.1AB-2005) protocol as listed below:

- » Chassis ID
- » Port ID
- » Time-to-live
- » Port Description
- » System Name
- » System Description
- » System Capabilities
- » Management Address

Therefore, when a neighbor supports LLDP, the mentioned TLVs will be recollected even if this neighbor does not run the WRZ-OS. The same apply in the over way, and the standard TLVs shared by the WRZ-OS device should be properly retrieved by any LLDP compatible device.

7.3.2 Configuration

In order to stop sharing device information to neighbors, the user must disable the LLDP protocol. By doing this, the device will also stop collecting information from its peers. (A configuration per ports will be coming soon).

Disabling LLDP can be performed through the wrz_config tool in the CLI. Once the tool is launched, the related parameter can be found under Management > LLDP as shown below.

```
*** LLDP configuration parameters ***
enable (y) --->
```

Figure 7-4: LLDP configuration from CLI

Alternatively, the LLDP can be configured using the following parameters:

OID	Name	Value Type	Description
20.1100.0	Enable	<Boolean>	Enable sharing/collecting information between direct neighbors using LLDP.

7.3.3 Info/Overview



Note: In the current release (v3.1.x), LLDP information is not displayed by the web interface and can be only visualized from SNMP or using the CLI.

For each active network interface, LLDP will send its own information to the corresponding peer and recollect the information from the same peer if compatible with LLDP.



Note: Only active interface with a compatible LLDP neighbor are displayed. Other interfaces are leaved disabled. This means that if no neighbors are running a compatible LLDP agent, the LLDP daemons of this device will be empty.

The information gathered by each port running LLDP is then structured into three categories:

- » Device: Information related to the system run by the neighbor.
- » Port: Information related to the neighbor port.
- » Management: Information about how the corresponding neighbor is managed.

OID	Name	Value Type	Description
20.xx10.x	net/wrX/peer/		Information about LLDP for the wrX network interface. (Where OIDs follow the given pattern: wr0 → 20xx, wr1 → 21xx, ..., wr15 → 35xx)
20.xx11.x	net/wrX/peer/1/dev		Information related to the system run by the neighbor

OID	Name	Value Type	Description
20.xx11.0	ID	<String> (i.e., 64:fb:81:20:80:06)	Unique identifier of the peer device (a.k.a Chassis ID): On WRZ-OS the MAC address of eth0 is used to ensure uniqueness
20.xx11.2	System Name	<String> (i.e., be-dist32-090)	Name of the system running on the peer device. By default, the hostname of the device is used.
20.xx11.3	System Description	<String> (i.e., WRZ-OS v3.2.1 for WR-ZEN TP-32BNC)	Description of the system running on the peer device
20.xx11.10	Firmware Version	<String> (i.e., v3.2.1-RC5)	Firmware version of the corresponding WRZ-OS (only) peer.
20.xx11.11	Hardware Version	<String> (i.e., WR_ZEN-v3.1)	Hardware version of the corresponding WRZ-OS (only) peer.
20.xx12.x	net/wrX/peer/1/dev/timing		Information about the timing configuration of the neighbor
20.xx12.1	Status	<String> (i.e., Ok)	General status of the peer device.
20.xx12.2	VCS Code	<Integer> (i.e., 20001)	Virtual clock use case code.
20.xx12.3	Message	<String> (i.e., Locked (TRACK_PHASE))	Extra information for the vcs_code (Locked state, warning condition, etc).
20.xx12.4	Active Reference	<String> (i.e., BC: WR @ wr1)	Message that contains the Active reference.

OID	Name	Value Type	Description
20.xx20.x	net/wrX/peer/1/port		Information related to the neighbor port
20.xx20.0	ID	<String> (i.e., 64:fb:81:20:88:06)	Unique identifier of the remote port (a.k.a port ID). For WRZ-OS peers, the MAC address of the corresponding port is used.
20.xx20.3	Description	<String> (i.e.,wr0)	Description of the remote port. For WRZ-OS peers, it corresponds to its interface name.
20.xx22.x	net/wrX/peer/1/port/sfp		Information related to the neighbor SFP
20.xx22.1	Vendor Name	<String> (i.e., Axcen Photonics)	SFP vendor name.
20.xx22.2	Part Number	<String> (i.e., AXGE-3454-0531)	SFP part number.
20.xx22.3	Serial Number	<String> (i.e., AX17460000223)	SFP serial number.
20.xx22.4	Transmission Wavelength	<Decimal> (i.e., 1490.000000)	SFP transmission wavelength.
20.xx22.5	DOM Availability	<Boolean> (i.e., Yes)	SFP DOM present flag.
20.xx22.6	Temperature	<Decimal> (i.e., 0.000000)	SFP temperature.
20.xx22.7	Reception Path Power	<Decimal> (i.e., 0.000000)	SFP power measurement for Rx path.
20.xx30.x	net/wrX/peer/1/mgmt		Information about how the corresponding neighbor is managed.
20.xx30.0	Address	<String> (i.e., 192.168.7.36)	Management address of the remote peer.

7.4 Healthing

The healthing module provides general information about the system health for monitoring purposes. This includes information about the fans, power supplies, memories, or temperature between others.

7.4.1 Information/Overview

The associated parameters can be accessed through the Healthing tab in the web GUI or the command line:

Alternatively, the LLDP can be configured using the following parameters:

OID	Name	Value Type	Description
2.1001.10	Uptime	<Time> (DD:HH:MM:SS)	Up time since the last reboot our power cycle.
2.1001.11	Local time	<Date and Time> (YYYY-MM-DD HH:MM:SS (UTC))	System date and hour in UTC format.
2.1001.20	RAM total	<Integer> (i.e., 511348)	Total available RAM.
2.1001.21	RAM free	<Integer> (i.e., 93884)	Remaining free RAM.
2.1001.31	CPUs	<Integer> (i.e., 2)	Total available CPUs.
2.1001.31	CPU load 1	<Decimal> (i.e., 0.054199)	Average CPU load during the last minute.
2.1001.32	CPU load 5	<Decimal> (i.e., 0.054199)	Average CPU load during the last 5 minutes.
2.1001.33	CPU load 15	<Decimal> (i.e., 0.054199)	Average CPU load during the last 15 minutes.
2.1001.34	CPU usage	<Decimal> (i.e., 0.054199)	Average CPU usage percentage in all cores.
2.1001.40	HDD1 size	<Integer> (i.e., 1046516 kB)	BOOT partition hard disk memory size.
2.1001.41	HDD1 free	<Integer> (i.e., 966132 kB)	BOOT partition free hard disk memory size.

OID	Name	Value Type	Description
2.1001.50	HDD2 size	<Integer> (i.e., 13785168 kB)	DATA/MEDIA partition hard disk memory size.
2.1001.51	HDD2 free	<Integer> (i.e., 12906276 kB)	DATA/MEDIA partition free hard disk memory size.
2.1001.60	FPGA temp	<Decimal> (i.e., 60 °C)	Measured temperature in the FPGA.

Additionally, to these parameters, the system defines several smart alerts that comprise the information from several parameters to ease the monitoring, providing a quick overview of the general status:

OID	Name	Value Type	Description
2.1002.1	Global state	<Enum> 0. Ok 1. Warning 2. Critical	Global status including timing and system parameters.
2.1002.2	Timing state	<Enum> 0. Ok 1. Warning 2. Critical	Timing status extracted from the virtual active clock.
2.1002.3	System	<Enum> 0. Ok 1. Warning 2. Critical	System status extracted from the healthing parameters.

The devices incorporate redundant power supplies and fans. In order to ensure their proper behavior, their information can be checked too in the web GUI under Healthing or through the command line:

OID	Name	Value Type	Description
0.91x0	pws/pwsX/		Information related to pwsX where pws1 (0.9100) corresponds to the left power supply and pwsr (0.9120) corresponds to the right power supply.
0.9110.1	Status	<Enum> (i.e., OK)	Power supply status.

OID	Name	Value Type	Description
0.9110.1	Temperature	<Decimal> (i.e., 41 °C)	Power supply temperature.
0.9110.1	Voltage In	<Decimal> (i.e., 233.250000 V)	Power supply input voltage.
0.9110.1	Voltage Out	<Decimal> (i.e., 11.949219 V)	Power supply output voltage.
0.9110.1	Power In	<Decimal> (i.e., 30.000000 W)	Consumption of the power supply input power.
0.9110.1	Power Out	<Decimal> (i.e., 24.000000 W)	Consumption of the supply output power.
0.91x0	fan/fanX/		Information related to the module fanX. (Where OID 9210→ fan0, 9220→ fan1)
0.92x0.1	Status Front	<Enum> 0. OK 1. Unplugged 2. Stopped 3. I2C Error	Status of the front ventilator of fanX module.
0.92x0.2	Status Back	<Enum> 0. OK 1. Unplugged 2. Stopped I2C Error	Status of the back ventilator of fanX module.

7.4.2 Configuration

Inside the healthing module, there are a few parameters that can be configured:

```

*** Healthing configuration parameters ***
(1) screen_saver
(60) screen_saver_delay
(255) screen_contrast
(60) temp_target (NEW)
    fan0 --->
    fan1 --->
    pws1 --->
    pwsr --->

```

Figure 7-5: Healthing configuration through CLI.

The healthing, fans and power supply configuration parameters can be found in the following table:

OID	Name	Value Type	Description
2.1000.0	Screen saver	<Integer> (i.e., 1)	Not used in WR-ZEN device.
2.1000.1	Screen saver delay	<Integer> (i.e., 60)	Not used in WR-ZEN device.
2.1000.2	Screen contrast	<Integer> (i.e., 255)	Not used in WR-ZEN device.
2.1000.3	Temp target	<Integer> (i.e., 60 °C)	Target temperature for the fans PWM controller
0.9110.7	PWSL disable alert	<Enum> - No - Yes	Disable left power supply alerts.
0.9120.7	PWSR power OUT	<Enum> - No - Yes	Disable right power supply alerts.
0.9210.5	Fan 0 disable alert	<Enum> - No - Yes	Disable fan 0 alerts.
0.9220.5	Fan 1 disable alert	<Enum> - No - Yes	Disable fan 1 alerts.

7.5 LCD screen menu

The WR-ZEN family includes an LCD screen where you can see some configuration values and the state of the device.

7.5.1 Screen Saver



This is the screen you usually see when not interacting with the device. This is a screen saver screen, showing the IPs of each interface to connect to the device. When you press INFO/CTRL button the main menu will appear.

You can configure the screen saver options with these parameters:

- » `cfg/screen_saver`:
 - » 1: screen saver configured.
 - » 0: no showing screen saver (the screen turns off when `screen_saver_delay` is reached).
- » `cfg/screen_saver_delay`: time without pressing INFO/CTRL button before active `screen_saver`.

You can change these values through `gpa_ctrl` or `snmp`.

7.5.2 Main Screen

When you press INFO/CTRL button, or if the screen saver is not active, you can see the main screen.

The main screen has the next structure:

	mode	clock
	BC: WR @ wr0	02:17
ip eth1	ETH 1 192.168.77.100	32
ip eth0	ETH 0 172.17.5.131	
hostname	wrztpe-494	✓
hardware version	HWR v3.3-S6_494	
firmware version	FWR v3.3	
	status	

This screen shows the general status of your device. Status can be:

- » Ok: All is ok.
- » Alert: There is at least a parameter with warning values.
- » Critical: There is a problem with at least one parameter value or module.

If you press INFO/CTRL button, the main menu will show.

7.5.3 Main Menu



To select an option, long press over INFO/CTRL button. To go to the next option, short press over INFO/CTRL button.

The different options in this menu are:

- » REVIEW PARAMETERS: Select this submenu to review the status and values of all modules and parameters in the device.
- » NETWORK: This submenu allows you to review the eth0 and eth1 info and white rabbit network status.
- » WR STATS: It shows info about white rabbit statistics.
- » MANAGEMENT: It allows to execute simple predefined actions like rebooting the device or restore the default configuration.

REVIEW PARAMETERS



This screen shows the global status of the modules running in the device.

- » S: Status:
 - » OK: all is ok.
 - » !(warning): at least one parameter in warning range.
 - » X (critical): at least one parameter in critical range, or there is a problem with the module.
- » W: All parameters in warning range.

- » C: All parameters in critical range.
- » O: Out of sync.

You can view details of each module by pressing long INFO/CTRL button over the module you want to review.



The module status description is shown. The different options to select in this screen are:

- » WARNINGS(n): select this option to review parameters in warning range.
- » CRITICALS(n): select this option to review parameters in critical range.
- » OUT OF SYNC(n): select this option to review parameters which are out of sync.
- » SHOW ALL PARAMS: select this option to review all parameters in the module.

Where n is the number of parameters in that condition.

If you select any of the above options, the screen will show information about the parameters that caused the special status. If there are 0 parameters with a special status, it will not enter the sub-menu.



To exit this screen, long press over INFO/CTRL button. To go to next parameter, short press over INFO/CTRL button. When the last parameter was reached, a short press over INFO/CTRL exits this screen, returning to the previous menu.

NETWORK

In this section you can review the parameters regarding the network interfaces of the device.



The options are:

- » ETH0: information about copper interface Ethernet 0.
- » ETH1: information about copper interface Ethernet 1.
- » WRO: information about fiber interface White Rabbit 0.
- » WR1: information about fiber interface White Rabbit 1.



When you select ETH0 or ETH1 option the details of the Ethernet interface will appear:

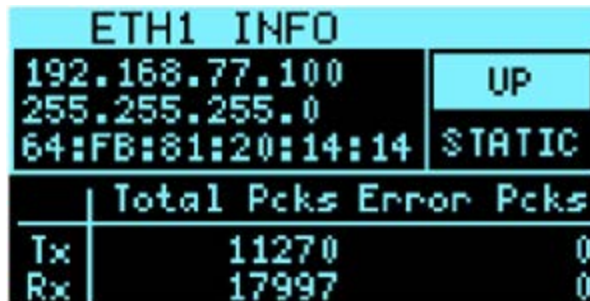

When you select WRO or WR1 option the details of the White Rabbit interface will appear.

WRO INFO		
WR_SLAVE		DOWN
08:00:30:6C:8A:28		LOCK
	dtx/drx Tx/Rx count	
Tx	46407	0
Rx	167843	0

WR STATS

REVIEW PARAMETERS	
NETWORK	
WR STATS	
MANAGEMENT	
<-- BACK	

In this sub-menu you can review the information about white rabbit:

UNKOWN	
state:	INVALID
rtt:	0
delay_ms:	0
update_count:	0
TAI time	
00:00:00.000000000	

MANAGEMENT

In this section you can perform simple predefined actions like rebooting the device or restore the default configuration.

The options are:

- » POWER OFF: Power off the device in a safe way.
- » REBOOT: Reboot the device.
- » REBOOT WR: Reboot white rabbit.
- » TOGGLE M/GM: Activate/Deactivate Grand-Master mode.
- » FACTORY RESET: Reset the value of all parameters to factory configuration.

Once you select an option by long pressing INFO/CTRL button, a countdown is shown:



By press INFO/CTRL button you can cancel the execution of the option selected. When countdown reaches 0, the option will be executed.

7.6 External monitoring tool

For this new architecture firmware version, an external Grafana monitoring application has been developed in order to provide the user a deep knowledge of the configuration and features of complete topologies with WR devices. This application is available for customers with premium support subscriptions. If you interested in this tool for your application, contact TimingSupport@orolia.com for more information.



The monitoring tool allows the user to be conscious of the device status and the specific topology designed on their network. It is useful to control some parameters as the offset from master time. Thanks to the storage of the parameters into an Influx Database, it is possible to obtain the device information during any time interval.

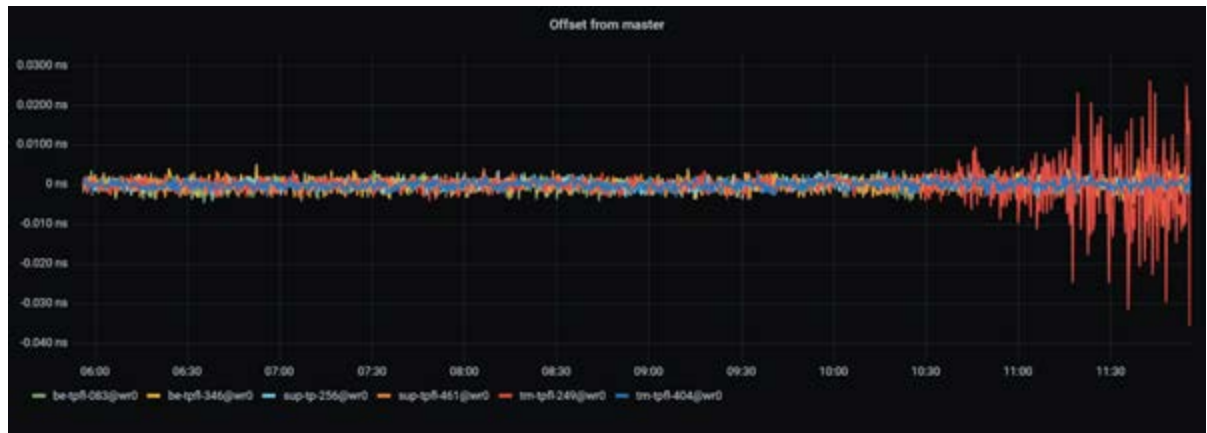

As seen in the previous graph, the unusual behavior on some devices can be detected. The red samples show the instances in which a device reaches high picks regarding the offset from the master device. For this reason, the monitoring tool helps the user to isolate issues that are difficult to understand.

The application also helps to prevent issues in the network due to periodic controls that can be performed. Furthermore, an alert storage functionality is added to the tool, allowing the user to obtain the anomaly reason in a quick and easy way.

CHAPTER 8

Device Maintenance

The following topics are included in this Chapter:

8.1 Licenses	132
8.2 Firmware Update	138
8.3 Recovery Mode	142
8.4 Factory Config Mode	144
8.5 Failsafe Mode	144

8.1 Licenses

Some additional features require a specific license in order to benefit from their full potential. This section will provide a quick guide on how to:

- » Buy a new license.
- » Install a new license.
- » Check if license has been activated.
- » Perform maintenance on a license.

8.1.1 List of related Licenses

The available feature licenses related to WR-ZEN are:

Group	Feature Name	Description
PTP	ptp_profile_cfg	Unlock the configuration of different options to enable other profiles than the default such as telecom profiles ITU-T G.8265.1, G.8275.1 and power profile IEEE C37.238-2011.
HATI	hp_port	Enable High-Performance HATI support for a given port. The HATI (High Accuracy Timing IP) is a FPGA core designed to easily integrate high-accuracy timing into Xilinx FPGA. Please, contact with info.spain@orolia.com for more information.

8.1.2 Check Licenses

The status of the licenses on the device can be retrieved under: Management > Licenses > Overview as shown in the figure below:



Note: Matching Device hardware: Orolia distributes different WRZ-OS firmwares according to the hardware family and version of the device. The user must follow indications provided in "[Firmware Update](#)" on page 138 to get the corresponding firmware before proceeding to its update.

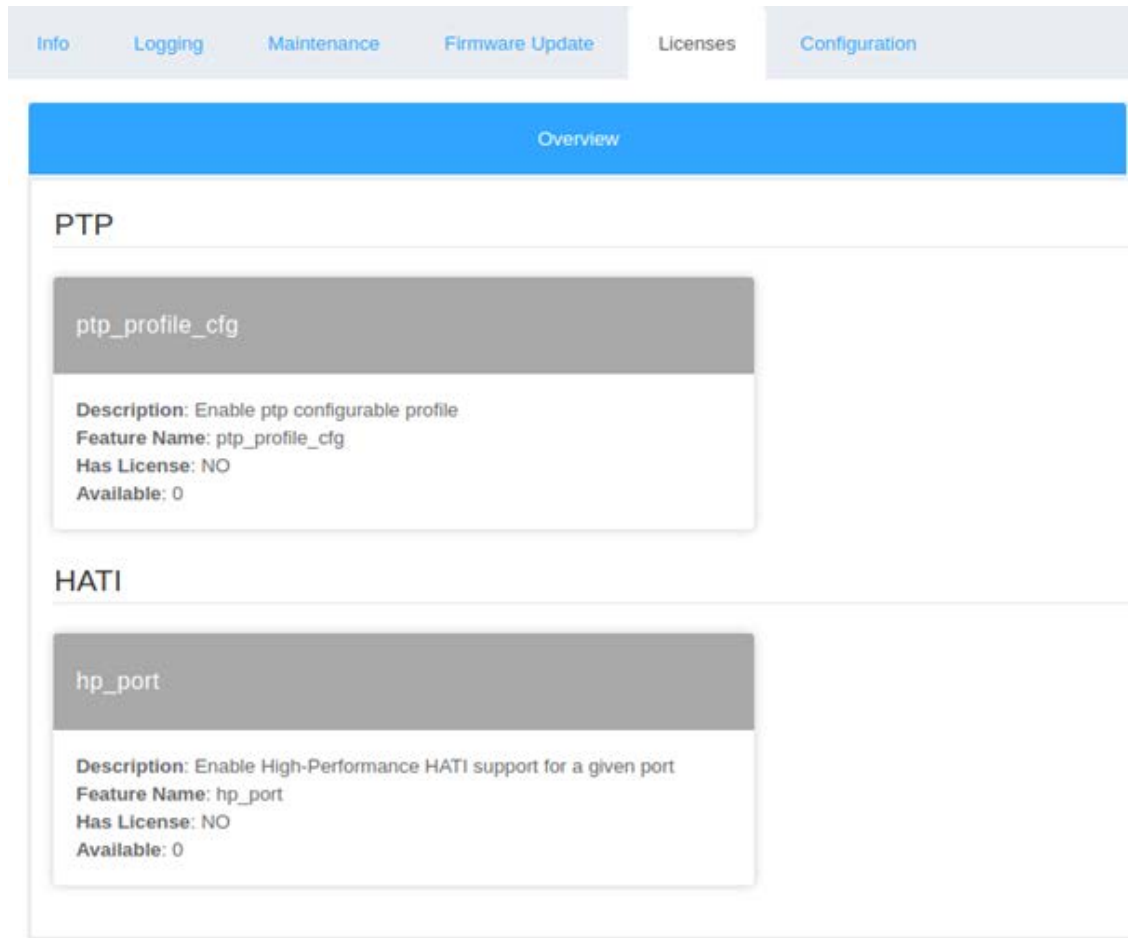

Figure 8-1: Checking available licenses.

Each possible license available for the WR-ZEN devices is represented by a single box where its status is summarized by the color of the box:

- » Grey: License is not available (See Figure 8:1 - Checking available licenses.).
- » Yellow: License is in trial.
- » Green: License is properly activated.

OID	Name	Value Type	Description
12.2xyy.	licenses/xxx/yyy/		Information about license feature <yyy> in group <xxx>.
12.2xyy.1	Feature Name	<String>	License feature name.

OID	Name	Value Type	Description
12.2xyy.8	Available	<Integer>	Total of available corresponding licenses by device (i.e., features associated to port might need up to 16 licenses).
12.2xyy.15	Description	<String>	Description of the corresponding license feature.
12.2xyy.20	Has License	NO YES TRIAL ONLY	Status of the license for the corresponding feature.

8.1.3 Order Licenses

Usually, the licenses are purchased together with the devices. This eases the ordering and installation procedure.

In some cases, additional licenses must be purchased afterward: The recommendation is to contact the corresponding FAE in order to receive assistance during this procedure. Alternatively, contact info.spain@orolia.com for a quotation.

Once the purchase has been confirmed, an email will be sent providing the credentials to access the Seven Solutions Licenses Portal.



Note: For security reasons, the generated temporary password expires quickly. Click on “Forget password” in case it was already expired.

8.1.4 Local Licenses Management

In order to perform local licenses management by directly uploading licenses files to the device the user first needs to login to the license portal by clicking on the following link:

<https://flex1667.flexnetoperations.com/flexnet/operationsportal/logon.do>

8.1.4.1 Map a feature to a device

- » The user must first navigate to the tab Devices > Devices.

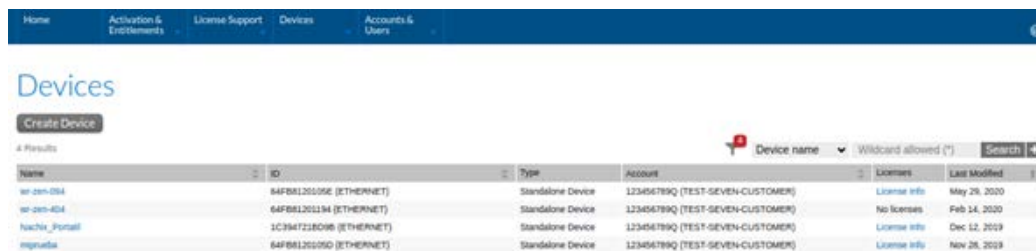

Figure 8-2: Devices Management in License Portal.

- » Then, click on the corresponding device to map the new feature. If this device does not appear in the list, first create it (See the following section, Create a New Device).
- » Once inside the corresponding device, click on Action > Map Entitlements to perform the association.
- » This panel (Figure 8:3) allows to map any purchased licenses to this specific device. The user only needs to specify the quantity of a given feature license to associate to the device and save it.



Mapping Purchased Licenses to Device.

- » At this point the license(s) is(are) associated but still not generated yet. By clicking on the Action > Download Capability Response a license file (.bin) will be automatically generated and downloaded. After refreshing the screen, the corresponding Status should be updated to License generated.



Note: A license file will be generated using a <DEVICE_ID>.bin filename pattern. Do not rename this file otherwise it will not be properly recognized when loading it to the device. If a <DEVICE_ID>.bin file is already present in your Download folder, the new generated file will be automatically renamed with a prefix (i.e., <DEVICE_ID> (1).bin). Please remove this prefix before uploading the file.

8.1.4.2 Create A New Device

- » First click on Create Device Button.
- » The fill the following parameters:
 - » Name: unique device name on the network. It is recommended to use the same name as the hostname.
 - » Run Licenses Server: Disabled
 - » ID Type: ETHERNET
 - » ID: It corresponds to the eth0 physical address (MAC) of the device.



Note: The device ID format is based on the eth0 MAC address, but without the double-dot (:) and with only upper-case characters. It can also be obtained from a terminal by executing:
`gpa_ctrl hald net/eth0/ethaddr | sed 's://g'`

8.1.4.3 Load local license file in the device

In order to load the generated license file, the user first needs to access to the Management > Licenses > Configuration tab (Figure 8:4) within the web interface of the device.

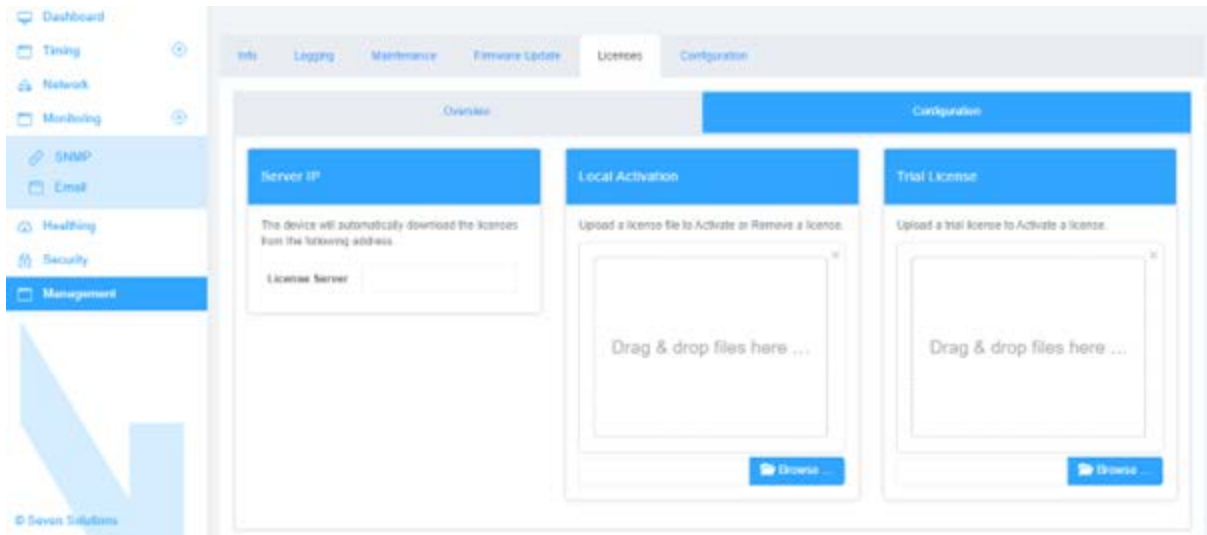

Figure 8-3: Licenses Configuration Panel

Then under Local Activation the user should Browse to the downloaded license file, Upload it to device and finally Save & Apply the changes

Once the operation is done, the user can review if the license has been properly activated (Green) by returning to the Management > Licenses > Overview screen.

8.1.4.4 Remove local license from device

In case a local license needs to be used in another device the user should first remote it from the previous device before associating it to the new one.

- » Access Seven Solutions Flexera Portal.
- » Go to the "previous" device.
- » Click on Action > Remove Licenses.
- » Select the quantity of the corresponding license to remove and Click Save.
- » Review that the Status of the licenses to remove is Waiting for confirmation.
- » Then click on Action > Download Capability Response.
- » Upload previously downloaded file as described in the previous section, "[Load local license file in the device](#)" on the previous page



Note: If <DEVICE_ID>.bin file is already present in your Download folder, the newly generated file will be automatically renamed with a suffix (i.e., <DEVICE_ID> (1).bin). Please remove this prefix before uploading the file.

- » If everything works as expected, a <DEVICE_ID>.bin.confirmation should be generated back.
- » Return to Seven Solutions Flexera Portal.
- » Click on Devices > Offline Device Management.
- » Select the Generated License option and then select the previously downloaded <DEVICE_ID>.bin.confirmation to Upload it.
- » Finally review if the license has been properly unlinked from your device. If it is the case, this means that the corresponding purchased license can now be mapped again to any other device.

8.1.5 License Server

It is not recommended to use local license management when running multiple (>10) devices in the network. A license server can be setup in the management network so that all the devices can directly request an active license to enable a feature. This solution has the following advantages:

- » Only license server must synchronize to license portal in order to get all the purchased license. This synchronization can be done online (seamless) or offline (using a file).
- » Each device only needs to configure the License Server IP.
- » The license server is viewed as a poll of license that will distribute licenses to the device only when they need them. This means that a license does not need to be associated to a specific device (e.g., an offline/backup device will not consume any licenses until it is connected to the network).

In order to get more information about this alternative, contact Orolia for assistance on the solution that best fits the topology and help through its setup.

8.2 Firmware Update

There are two different ways to update the software and firmware of the device: through the web interface or by using SSH/SCP.



Note: Matching device hardware: Orolia distributes different WRZ-OS firmwares according to the hardware family of the device. The user must follow indications provided in "[Hardware version and firmware](#)" below to get the corresponding firmware before proceeding to its update.



Caution: The configuration is NOT compatible between major versions. If the major version changes (for example from 2.X to 3.X or vice-versa), the configuration on the device must be removed and configured again.

8.2.1 Hardware version and firmware

The HW version is displayed in the dashboard. The device below is a WR-ZEN TP that mounts a ZENv3.3 as main board.



Figure 8-4: HW version displayed in dashboard.

The WR-ZEN TP can be updated using the firmware that matches the version of the main board, or the new generic family firmware developed from the 3.4 software version:

- » `wr-zynq-os-v<XXX>-<YYYYMMDD>-ZENx.x_binaries.tar`
- » `wr-zynq-os-v<XXX>-<YYYYMMDD>-ZEN3.x_binaries.tar`
- » `wr-zynq-os-v<XXX>-<YYYYMMDD>-ZEN_binaries.tar`

But not the one that correspond to another device:

- » `wr-zynq-os-v<XXX>-<YYYYMMDD>-Z16x.x_binaries.tar`

Or the one that corresponds to another hardware version

- » `wr-zynq-os-v<XXX>-<YYYYMMDD>-ZEN2.x_binaries.tar`

8.2.2 Using Web interface

Once the web GUI of the device has been properly opened (See "[Connecting to the Device](#)" on page 26), navigate to the Management > Firmware Update panel.

- » The corresponding firmware tar ball can be drag-n-dropped or Browse from the PC.
- » Then, press on Upload button and wait until checking the compatibility of the given firmware. If the firmware is detected to be compatible it will automatically start the upgrade procedure and reboot (twice) the device. Please wait in this screen until the procedure complete.



Figure 8-5: Update Procedure Waiting screen.

- » If the uploaded version is lower than 3.4, a factory reset is mandatory. If this is the case, the message in the following Figure will appear.



Figure 8-6: Downgrade warning on the GUI.

- » If an incompatibility (figure below) has been detected, the user should NOT continue with the flashing procedure except if the support team has confirmed that this is the way to fix a specific problem.

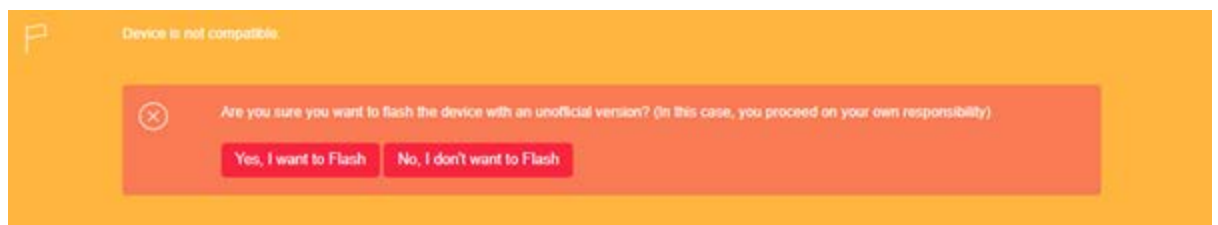

Figure 8-7: Force flashing incompatible firmware.

- » If the hardware version is higher or equal to 5.0 and the software version is lower

than 3.4, flashing will not be possible and a warning will be given.

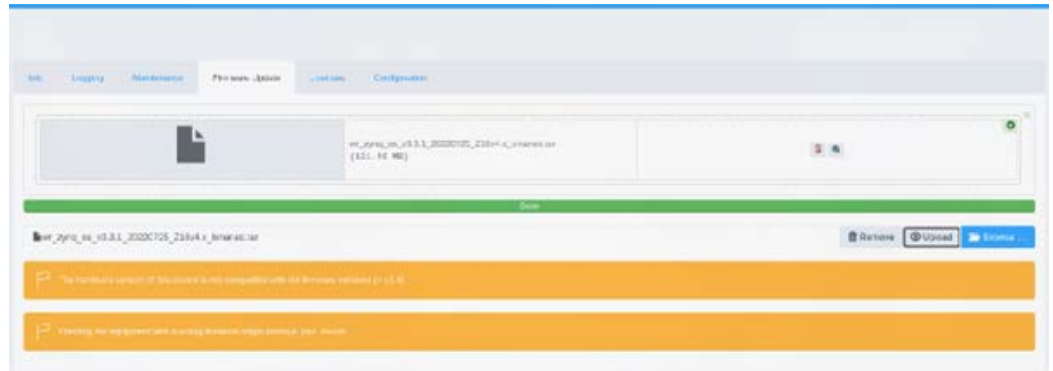

Figure 8-8: Flashing hardware v5.0 with incompatible firmware.

8.2.3 Using SSH/SCP

A new firmware can be updated using SSH and SCP protocols. This method allows a secure way to perform a batch firmware update to many devices at the same time.

The first step of this method is to upload the corresponding firmware to the root folder of the device using SCP:

```
scp wr-zynq-os-v3.2-RC1-20210325-ZENv3.x_binaries.tar root@<deviceip>:~
```

Then login to the device with SSH:

```
ssh root@<deviceip>
```

And finally run the wrz_flashfw tool to handle updates with the reboot flag if no errors were detected:

```
root@be-dist8-684:~# wrz_flashfw -r ~/ wr-zynq-os-v3.2-RC1-20210325-ZENv3.x_binaries.tar
```

If the uploaded version is lower than 3.4, a factory reset is mandatory. If this is the case, the following message will prompt after executing the previous command:

```
Warning: The version to be flashed is older than the current one, therefore the default password and user are going to be set. The device will be automatically rebooted...
```

This will reset the device in its factory version and all your modifications will be lost

```
Do you want to continue? [y/N] ?
```



Note: Please check `wrz_flashfw -h` to get more information about the various arguments accepted by this tool.

8.3 Recovery Mode

If an error has occurred (e.g., power down, wrong firmware) during a firmware update procedure the device might not be able to boot from the SD card and will enter itself into a recovery mode.

This recovery mode consists of a minimal Linux stored into internal memory of the equipment that allows to:

- » Reflash the device with another firmware.
- » Recover configuration (if possible).
- » Clean/format SD remotely.

Once the device has been booted in recovery mode, it should apply the network configuration previously saved in the `.config` file. However, it might occasionally be impossible to recover the network configuration. In those cases, the device will be accessible using the default network parameters ("[Default Configuration](#)" on page 26) or through front USB-UART serial connection.

The following actions might be considered to try to repair the device. It is recommended to try them in the given order:

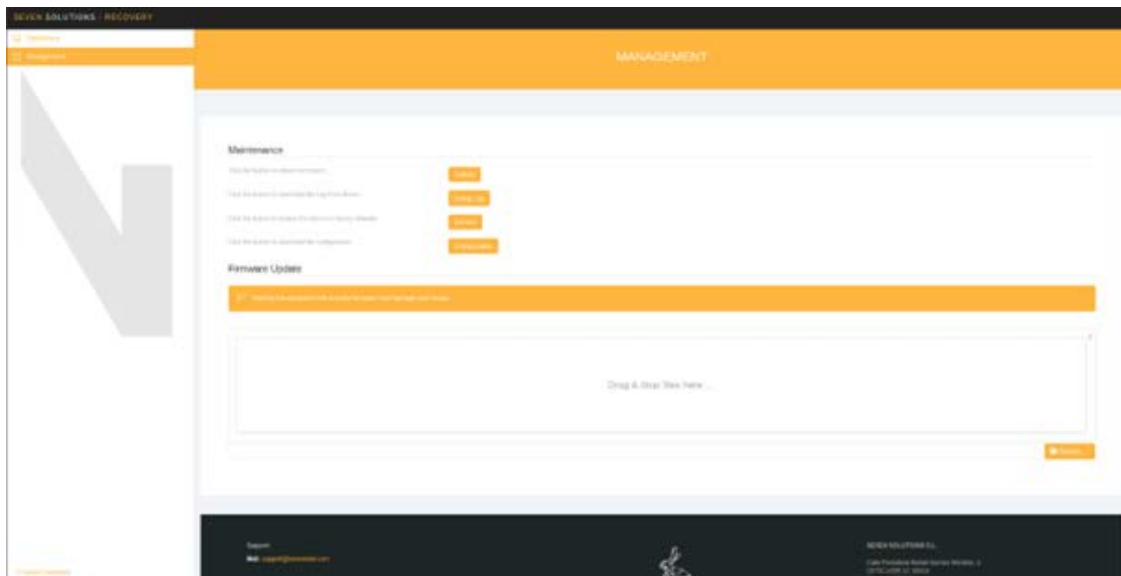

Figure 8-9: Management panel in recovery mode

1. **Configuration:** One of the first things to do when a device is in recovery mode is to try to back-up its configuration, so it is easy to import it back or load it to another device.
2. **Reboot:** Then, try to reboot the device as the recovery mode has already performed an automatic filesystem check and cleaning. If the device reboots in normal mode, this means that the error in SD partition has been automatically fixed, otherwise another recovery action might be executed.
3. **Firmware Update:** Try to flash the firmware again (this is the most frequent action to perform when an error has occurred during the flashing procedure).
4. **Restore:** Remove any customization and restore the device to its default values (WARNING: Any specific network settings will be removed).

If none of these actions can return the device to a normal booting mode, contact "[Technical Support](#)" on page 153 to get more help.

8.3.1 Manual recovery mode

8.3.1.1 Using reset button

In case the recovery mode must be entered manually, the following steps need to be performed:

1. Reboot the WRZ device.
2. Press the reset button (2.1 Front panel) around 5s while the device is booting and release the button when the status led is blinking.
3. The status LED should light red (See "[Monitoring LEDs](#)" on page 16).
4. Wait until the recovery image is loaded from QSPI dataflash (This can take more than 1 minute).

8.3.1.2 From Serial UART

The recovery mode can also be started from Uboot console (Connected to the serial RJ45-UART) when it is not possible to access the reset button:

1. Press any key when seeing:

```

Loading wr7shw preboot...
U-Boot 201X.xx-wr7s-vX.X (Jun 25 2018 - 16:07:12) ZENv3
WR_ZEN-vx.x-Sxx_xxx
Hit any key to stop autoboot: 0
  
```

2. Execute:

```
wr7s-uboot> env run recoveryboot
```
3. Wait until the recovery image is loaded from QSPI dataflash (This can take more than 1 minute).

8.4 Factory Config Mode

In case a miss configuration of the device invalids its correct login, one can manually reset the configuration to default factory value by following the steps below:

1. Reboot the WRZ device.
2. Press the CTRL/Info button more than 15s while Uboot is loading.
3. Hold until reset factory message appears on LCD status LED light in yellow (See "[Monitoring LEDs](#)" on page 16).
4. Wait until the device reboot with default factory parameters.



Note: The factory config mode does not revert the device to its factory firmware. It only removes all the configurations and customizations stored by the user and will reboot the device using a clean version of the last firmware flashed.

8.5 Failsafe Mode

The Failsafe mode allows to only load the minimal Linux services (i.e., logging, network, ssh, web) but using the normal firmware stored in SD card. It has been mainly designed for advanced users that might have blocked the startup of the device through a bad customization of init.d services.

So, if after a failed customization, a device does not provide a usable access to its console (ssh or UART), the failsafe mode can be entered by following the procedure:

1. Power cycle the device.
2. Wait 30 second until the kernel starts loading.
3. Press Reset Button (#2) for more than 30s until Status LED (#3) starts blinking several times in yellow. This mean that the failsafe mode has been triggered.
4. Remove/fix the custom scripts that were blocking the OS initialization.



Note: Factory reset vs. Failsafe mode: If the device initialization is blocked due to a custom script, it might be easier to directly perform a factory reset even if this means that the device will lose all its configuration.

BLANK PAGE.

Appendix

The following topics are included in this Chapter:

9.1 Acronyms	148
9.2 Troubleshooting	149
9.3 Technical Support	153
9.4 VCS Code	153
9.5 Persistent Custom Files	159
9.6 Timing outputs	160
9.7 TACACS+ and RADIUS server configuration	162
9.8 List of supported SFPs	164
9.9 List of Tables	164
9.10 List of Images	165
9.11 Document Revision History	167

9.1 Acronyms

Acronyms	Description
BC	Boundary Clock (Disciplined by a master and discipling slaves)
BMCA	Best Master Clock Algorithm
FR	Free Running (Undisciplined local oscillator)
GLONASS	Globalnaya Navigatsionnaya Sputnikovaya Sistema
GM	Grand Master
GNSS	Global Navigation Satellite System
GPS	Global Positioning System
HA	High Accuracy
HO	Hold-Over
HTTP	Hypertext Transfer Protocol
NMEA	National Marine Electronics Association
NMS	Network Management System
NTP	Network Time Protocol
PPS	Pulse Per Second
PTP	Precision Time Protocol
PPS	Precision Time Protocol
PWS	Power Supply
RTT	Round Trip Time
SFP	Small Form-factor Pluggable Transceiver for fiber link
SSH	Secure Shell
SNMP	Simple Network Management Protocol
SyncE	Synchronous Ethernet
TAI	International Atomic Time (Temps Atomique International)
ToD	Time of Day
UTC	Coordinated Universal Time
WR	White Rabbit

Acronyms	Description
WR-ZEN	White Rabbit Zynq Embedded Node
WR-LEN+	White Rabbit Lite Embedded Node Plus
WRZ-OS	White Rabbit Zynq based (Z16, ZEN, LEN+) Operative System

9.2 Troubleshooting

This section intends to help the user understand how to identify an issue in your WR-ZEN device, as well as giving some guidance to figure out the cause of the problem.

9.2.1 Frequently answered questions (FAQ)

A list of the most commonly asked questions will be described here, as well as the solutions that can be applied for each of the situations.

» **Why does the WR-ZEN report link down even if the SFPs are connected to the WR interfaces?**

One of the most common cause of this issue is related to not using matching blue-violet SFPs.

As in White Rabbit it is of uttermost importance to have equal cable lengths in both directions, a single fiber should be used for sending data both directions.

Additionally, White Rabbit should follow the 1000BASE-BX10 standard and use 1310/1490 pairs with a single LC connector. More specifically, the Switch ports transmitting downstream (to endpoints) should use 1490nm on the transmitter and 1310nm on the receiver.

The 1310 nm module corresponds to the blue color and the 1490 nm to the purple one.

» **What does the Error 500 mean while uploading the firmware? What is recommended to fix this issue?**

In this case, the best modus operandi is to reboot before flashing the device. Also check the file is not corrupted.

» **How can you confirm that external PPS/10 MHz signals are being detected?**

At the WR-ZEN's console, type:

```
root@zen- 425:~# gpa_ctrl hald /spl1/ext/fpanel/detected  
PPS & CLK
```

The expected output is PPS &CLK which means that both signals are detected.

9.2.2 Health general status

In order to check the device general status, there are multiple alternatives:

1. SSH/UART
2. Web interface
3. SNMP queries

SSH / mini-USB UART

If you connect to the device via SSH/UART you will be able to check the WR-ZEN6 sync status by typing:

```
gpa_ctrl healthingd  
gpa_ctrl tmgrd vclock/info/
```

The WR-ZEN web interface

You can access the WR-ZEN graphical interface by setting the device an IP and copying its address into the browser's URL bar.

General ports, mode and other configuration can be consulted or changed in the web.

SNMP.

This is the recommended alternative for monitoring purposes. Follow the steps on the attached Monitoring Tools User Guide to get SNMP working.

You will be able to both consulting or changing configurations on the WR-ZEN with the SNMP commands.

After having installed SNMP on your host, all parameters on the WR-ZEN can be checked by typing:

```
$ snmpwalk -v2c -c public <WR-ZEN IP>
```

9.2.3 Virtual State Clock Code Error

Virtual State Clock (VSC) Code Errors are codes that refer to different virtual clock states for debugging purposes.

The format for these codes is the following one:

VSC-XXXXXX

These codes provide information on the synchronization status in the device. For further details, please read the VSC Code Error table ("[VCS Code](#)" on [page 153](#)) containing all the possible values, each of them referring to a different condition.

9.2.4 How to report an error

1. If one of the devices experiments any technical issues, it would be recommendable to contact the Orolia Support Team (see "[Technical Support](#)" on [page 153](#)), which will be in charge of addressing the problem. These are the steps that should be followed in case a problem happens.
2. If the device is alive and accessible, please go to the WR-ZEN's web interface -> Management -> Download device's log dump.
3. Write to our Support Team at TimingSupport@orolia.com. Describe the issue found going into details.
 - a. What was the device's main activity before the error occurred? (e.g. the device was acting as a GM taking PPS/10MHz references from another one and running as a PTP master on interface wr0).
 - b. Were any relevant actions previously performed on the device before the issue happened? (e.g. upgrading firmware or applying any specific configuration)
 - c. Is the issue reproducible? Does it happen after specific actions are applied to the device or when a series of particular events happen in it?
 - d. Attach the device's log dump if it was possible to retrieve on step 1.
4. Our Support Team will open a case (find it on the replies' email subject) in order to find out the possible causes on the issue and will give guidance so it can be solved.

9.2.5 Rsyslog template to improve remote login

Logging in the WRZ-OS is managed by the rsyslog daemon, which is in charge of both storing the events happened in the WRZ-OS in the internal `/var/log/xxx` files and sending

them to a centralized rsyslog server.

In order to get rsyslog daemon sending all logs to a server, `/etc/rsyslog.conf` should be configured with the following lines:

```
module(load="imfile")

input                                     (type="imfile"
File="/var/log/systemlog"
Tag="custom"
Facility="local0"
Severity="info")

local0.* @<rsyslog server1 IP>
local0.* @<rsyslog server2 IP>
```

9.2.6 Warranty

The WR-ZEN device is fully factory tested and warranted against manufacturing defects for a period of one year. Failure of the WRZ device due to installation problems caused by the circumstances under the WRZ device is installed cannot be warranted. This includes misuse, miswiring, overheating, operation under loads beyond the design range of the WR-ZEN device.

For warranty or non-warranty replacement please write to our ["Technical Support" on the facing page](#) team at TimingSupport@orolia.com.

9.2.7 Contact

For more information about our company and products please contact us:

See ["Technical Support" on the facing page](#), or:

Website <https://sevensols.com/>

Address Seven Solutions S.L.

Calle Periodista Rafael Gómez Montero,

2 CETIC-UGR 13, 18014

Granada – SPAIN

Phone (+34) 958 285 024

Email info.spain@orolia.com

9.3 Technical Support

To request technical support for your WR-ZEN unit, please go to the ["Timing Support" page](#) of the Orolia website, where you can not only submit a support request, but also find additional technical documentation.

Phone support is available during regular office hours under the telephone numbers listed below.

To speed up the diagnosis of your WR-ZEN, please send us:

- » the current **product configuration**, and
- » the **log files**, if possible. Log on to the web interface and navigate to **Management** - > **Download device's log dump**.

Thank you for your cooperation.

9.3.1 Regional Contact

Orolia operates globally and has offices in several locations around the world. Our main offices are listed below:

Country	Location	Phone
France	Les Ulis	+33 (0)1 6453 3980
Spain	Granada	+34 958 285 024
USA	West Henrietta, NY	+1.585.321.5800

Table 9-1: Orolia contact information

Additional regional contact information can be found on the [Contact page](#) of the Orolia website.

9.4 VCS Code

The Virtual Clock Status Code has been created to easily identify the timing status of a device and easily troubleshoot in case it has failed. The VCS code are also used by the FOCA algorithm to detect a failure within a timing source and switch to the next available one.

9.4.1 Grand Master (GM VCS Code)

A device in Grand Master is when the timing source is external (i.e., 10MHz/PPS) or from a non-PTP source such as GNSS.

VSC	HO	Device Status	Message	Clock Class	Active Reference	Description
VSC-10000		OK	Locked	6	GM: Front-panel	Everything is OK for GM device
VSC-10101		CRITICAL	Unlocked: 10MHz not present	187	GM: Internal Oscillator	The 10MHz signal is not properly connected to the GM (or provide too low voltage, bad frequency, etc...)
VSC-10102		CRITICAL	Unlocked: PPS not present	187	GM: Internal Oscillator	The PPS signal is not properly connected to the GM (or provide too low voltage)
VSC-10103		CRITICAL	Unlocked: 10MHz+PPS not present	187	GM: Internal Oscillator	10MHz and PPS signals are not properly connected to the GM (or provide too low voltage)
VSC-10104		CRITICAL	Unlocked: 10MHz not stable	187	GM: Internal Oscillator	Timeout in locking or DAC blocked to the limit. ~99% of the case because 10MHz are not stable or correct and thus tmgr reach a timeout count
VSC-10110		WARNING	Locked: PPS not present	6	GM: Front-panel	In case we are using an Atomic Clock as the main reference and someone has unplugged the PPS cable we might have some problem on the next reboot. PPS defined as not mandatory by user
VSC-10201		WARNING	Locked: Time of Day was not set (NTP error)	6	GM: Front-panel	We have the same reference on all the network but the given ToD is not be valid: During boot we can not reach NTP server (timeout or IP not configured). The ToD used is provided by release ToD or last shutdown ToD.
VSC-10202		WARNING	Locked: Leap seconds file has expired	6	GM: Front-panel	Leapsec file in the GM device is expired or has reach expiration while the GM is running. This means that the GM can not guarantee the UTC-TAI conversion even if the currently leap seconds used is still valid

VSC	HO	Device Status	Message	Clock Class	Active Reference	Description
VSC-10203		WARNING	Locked: ToD offset bigger than 1s (NTP offset)	6	GM: Front-panel	We are seeing a drift with the current NTP offset (this is probably that NTP server has some server, but it could be that our external reference is in free-running)
VSC-10204		WARNING	Locked: NTP does not reply anymore	6	GM: Front-panel	As NTP does not reply we might have some problem with the network. This is not critical for operation but might be a problem at next reboot. Only the GM should send alert

9.4.2 Boundary Clock (BC VCS Code)

A device in Boundary Clock mode is receiving its timing from a PTP/WR master and redistribute to other PTP/WR slave devices.

VSC	HO	Device Status	Message	Clock Class	Active Reference	Description
VSC-20001		OK	Locked (TRACK_PHASE)	6	BC: WR @ ifname	The BC clock is locked using WR and the upstream device provide all the information properly set
VSC-20001		OK	Locked	6	BC: PTP @ ifname	The BC clock is locked using PTP and the upstream device provide all the information properly set
VSC-20004		OK	Locked - Upstream in manual Free-running	193	BC: WR @ ifname	The BC clock is locked using WR but the upstream device has been configured in free-running
VSC-20301		CRITICAL	No connected reference - link down	248	Internal Oscillator	The BC clock has no link with upstream device
VSC-21301	HO	CHANGEOVER	Lost connected reference - link down	187	BC: Holdover	The Link has been lost due to a link down (VSC-20301), but holdover was learnt (READY) and was quickly and automatically triggered (ACTIVATED)

VSC	HO	Device Status	Message	Clock Class	Active Reference	Description
VSC-20303		CRITICAL	No WR/PTP connected reference	248	Internal Oscillator	The BC clock has link with upstream device but does not properly receive any PTP announce message (or any other messages). This include the servo_state=NOT_UPDATED
VSC-21303	HO	CHANGEOVER	No WR servo update	187	BC: Holdover	Servo was locked but not receiving any PTP packets anymore. Tmgr detect servo_state=NOT_UPDATED, and exit to HO if this was READY
VSC-20305		CRITICAL	Can not lock to reference	248	BC: WR/PTP @ ifname	We receive announce PTP message, start locking with slave but can not reach the Locked state after a timeout (Wait Stable). This state is enforced by tmgr when it FSM is blocked in WAIT_LOCK until a timeout
VSC-20307		CRITICAL	SyncE SSM QL error - Not QL-PRC	248	Internal Oscillator	PTP+SyncE is in LOCKED state but the received QL code is not a PRC (ePRTC, PRTC). The device will announce itself in FR
VSC-21307		CHANGEOVER	SyncE SSM QL error - Not QL-PRC	187	BC: Holdover	PTP+SyncE was in LOCKED state but the received QL code is not a PRC (ePRTC, PRTC). The device will fail to our HO timing source if it was ready
VSC-20320		CRITICAL	Locked: Upstream device in Free-running	248	BC: WR/PTP @ ifname	The GM is not available in the network so we are locked to an upstream device
VSC-22320		CRITICAL	Upstream device in Free-Running	248	Passive WR/PTP @ ifname	The GM is not available in this network. This passive timing source can become active only if no better time source is available.

VSC	HO	Device Status	Message	Clock Class	Active Reference	Description
VSC-21320		CHANGEOVER	Upstream device in Free-Running	187	BC: Holdover	The GM is not available anymore in the network. Instead of staying locked to a FR upstream device we fail to our HO timing source if it was READY
VSC-20201		CRITICAL	Locked:Upstream GM in Free-running	187	BC: WR/PTP @ ifname	The BC clock is locked but the upstream GM has fallen in free-running for different reasons
VSC-22201		CRITICAL	Upstream GM in Free-Running	187	Passive: WR/PTP @ ifname	The GM is in this network is in Free-Running. This passive timing source can become active only if no better time source is available.
VSC-21201		CHANGEOVER	Upstream GM in Free-Running	187	BC: Holdover	GM announce itself to be now in FR, if we have an active HO we should exit through this state and fail to the HO timing source
VCS-20501		CRITICAL	PLL delocked: L1-Sync (Sync-E) error	248	BC: WR/PTP @ ifname	For some unexpected reason the MPLL is not able to follow the received frequency from L1-Sync (Sync-E) and it has been delocked.
VCS-21501		CHANGEOVER	PLL delocked: L1-Sync (Sync-E) error	187	BC: Holdover	For some unexpected reason the MPLL is not able to follow the received frequency from L1-Sync (Sync-E) and it has been delocked. If ready, the fast delock trigger launch the Holdover
VSC-20211		WARNING	Locked: Upstream device in holdover	187	BC: WR/PTP @ ifname	For some unexpected reason the MPLL is not able to follow the received frequency from L1-Sync (Sync-E) and it has been delocked. If ready, the fast delock trigger launch the Holdover

VSC	HO	Device Status	Message	Clock Class	Active Reference	Description
VSC-20110		WARNING	Locked: Time of Day not available on GM	6	BC: WR/PTP @ ifname	The GM announce a problem that its ToD has not been properly set since start. Probably due to an NTP error, the GM will stay there until restarting/re-evaluation of GM
VSC-20111		WARNING	Locked: Leap seconds file on GM has expired	6	BC: WR/PTP @ ifname	The GM time is announced has valid but the utc_offset is not valid. This means that leapsec file has expired at GM

9.4.3 Others

VSC	HO	Device Status	Message	Clock Class	Active Reference	Description
VSC-09000		OK	Timing source is ready	X	X	For ports, "Ready" means that the link is up and some announce messages sent by a master has been received. For GM, "Ready" means that 10M/PPS has been detected properly
VSC-09100		CRITICAL	System Error	248	Internal Oscillator	In case we get an unexpect behavior because some of the src modules (ppsi,ptpd,gNSS,hald) has crashed, The tmgr will enforce this status in order to alert to the management and also to other nodes (if possible) that our current situation is unexpected.
VSC-09110		WARNING	Initializing...	248	Internal Oscillator	The device will always initialize with the following configuration before using any policy/strategy/src in tmgr. The following value are only written in case the user run: /etc/init.d/tmgrd restart
VSC-90000		OK	Manual Free-running	193	Internal Oscillator	The device has been manually set as FR master and thus will distribute time according to its own reference

VSC	HO	Device Status	Message	Clock Class	Active Reference	Description
VSC-92000		OK	Idle Free-running	248	Passive	Passive state of the free-running timing source when Idle
VSC-92400	HO	OK	Holdover Ready	248	Passive	The Holdover timing source has been learning in background from the active timing source. It is now ready to being triggered.
VSC-92401	HO	OK	Holdover Ready	248	Passive	Transitional state
VSC-91101	HO	CRITICAL	Holdover Expired	7>187 187>248	Internal Oscillator	The device was previously in a HO exit state but and enter the holdover time source until it has finally expired. Even if we will still be connected internally to the HO clock, we announce ourself exactly like FR and we allow to reset the algorithm
VSC-91111	HO	WARNING	<previous message>	<prev>	<prev>	The last mode that was "ready" has been exited in HO mode. The only thing that we perform here is increasing our clock accuracy and stay in this mode until the timer expired
VSC-92411	HO	WARNING	Holdover Learning	248	Passive	The Holdover timing source is learning in background from the active timing source. If triggered, it will directly reach its expired state.

9.5 Persistent Custom Files

When an expert user needs to modify some configuration with custom settings (e.g., complex firewall rules) or wants to add new tools to the “official” firmware, he can use the custom mount directories mechanisms: This allow to store persistent files by placing them into the second ext4 partition on the SD drive mounted as `/media/data` which will be then mounted at next boot into the operating system directories:

Directory in SD drive	Mount points	Comments
<code>/media/data/update</code>	<code>/media/data/update</code>	Always created, used to update the FW

Directory in SD drive	Mount points	Comments
/media/data/root	/media/data/root	Root files where we can store the configuration
/media/data/usr/local/bin	/usr/local/bin	For custom binaries tools
/media/data/usr/local/sbin	/usr/local/sbin	For custom script
/media/data/usr/local/lib	/usr/local/lib	For custom libraries
/media/data/usr/local/etc	/etc/	Create symbolic links into the /etc dir



Caution: When updating with custom scripts to a new release, the expert user needs to check that its custom scripts do not interfere with the booting procedure of the new release. In case of doubt, please contact the support team to get advice on how to proceed.



Note: These directories are mounted/linked only at the early stage of WRZ-OS initialization. A reboot might be needed to make these custom files appear at the correct place.

9.6 Timing outputs

In the following chart, the relevant electrical information about the timing outputs in several WR-ZEN family devices is shown. Note that some of these devices are equipped with expansion cards (e.g., FPO in the case of the WR-ZEN TP-FL).

Device	Channel	Termination at the receiver device	Mode	High voltage	Raise time
WR-ZEN	1PPS OUT	50 Ohms (optimal) 1 MOhm (overshoot)	1PPS	~ 3.0 V	0.60 ns
WR-ZEN	CLK TTL	50 Ohms (optimal) 1 MOhm (overshoot)	10 MHz	~ 3.0 V	0.60 ns
WR-ZEN TP-FL FPO v1.0	A & B	50 Ohms (optimal) 1 MOhm (overshoot)	xPPS	~ 3.0 V	1.10 ns

Device	Channel	Termination at the receiver device	Mode	High voltage	Raise time
WR-ZEN TP-FL FPO v2.0	A & B	50 Ohms (optimal) 1 MOhm (overshoot)	xPPS & 10MHz	~ 3.0 V	0.80 ns
WR- ZEN TP- 32BNC EXP32BNC V2.0	A & B	1 Ohm (optimal) 50 Ohm (low volt)	xPPS & 10MHz	~ 3.3 V ~ 1.7 V	2.06 ns
	C & D	1 Ohm (optimal) 50 Ohm (optimal)	xPPS	~ 3.3 V ~ 3.0 V	1.55 ns 2.06 ns 1.67 ns
WR-ZEN TP- 32BNCEXP32BNC V2.2	A & B	1 Ohm (optimal) 50 Ohm (optimal)	xPPS & 10MHz	~ 3.3 V ~ 3.0 V	2.06 ns
	C & D	1 Ohm (optimal) 50 Ohm (optimal)	xPPS	~ 3.3 V ~ 3.0 V	1.67 ns 2.06 ns 1.67 ns
WR-ZEN TP TP-EXP V2.2 or higher	A	1 Ohm (optimal) 50 Ohm (low volt)	xPPS & 10MHz	~ 3.3 V ~ 1.7 V	1.80 ns
	B	1 Ohm (optimal) 50 Ohm (optimal)	xPPS & 10MHz	~ 3.3 V ~ 3.0 V	1.30 ns 1.80 ns 1.47 ns

9.7 TACACS+ and RADIUS server configuration

9.7.1 TACACS+ server installation and configuration

In order to install TACACS+ on a server with Ubuntu 18.04, it is possible to use APT to install version 4.0.4 of the package `tacacs+` by using the following command:

```
apt-get install tacacs+
```

After this, it can be verified if the service is running by using the command:

```
service tacacs_plus status
```

The first step to configure the server will be opening the port 49 with TCP:

```
#ufw allow 49/tcp
```

```
Rules updated
```

```
Rules updated (v6)
```

The users are configured in the file `/etc/tacacs+/tac_plus.conf`. To do this, it is possible to modify the key by replacing it by the one we want to define:

```
key = sevensecret
```

The following simple structure can be used to define a user:

```
user = test-tacacs {  
pap = cleartext password  
}
```

It is possible to encrypt the password with the `"tac_pwd"` terminal command and enter the password to the settings as follows:

```
pap = des yD0g3Qn/0ZDsg
```

Being `yD0g3Qn/0ZDsg` the encrypted password.

There are more sophisticated configurations that add complexity, such as using groups (which serve to put common characteristics to a group of users) or `acl` (which serves to accept or reject clients depending on their IP address).



Note: If your WR-ZEN unit has been used as the client, the password must be configured for the root user. Registration of new users is not allowed in this device so root is the only existing user.

After finishing with the settings, it is necessary to restart the protocol by using the following command:

```
service tacacs_plus restart
```

9.7.2 RADIUS server installation and configuration

In order to install RADIUS on a server with Ubuntu 18.04, it is possible to use APT to install the v3.0.16 of the package radius by using the following command:

```
apt-get install freeradius
```

It will also be necessary to install the certificates (version 20180409):

```
apt-get install ca-certificates
```

After this, the service status can be verified by using the command:

```
service freeradius status
```

The first step to configure the server is opening the UDP ports 1812 and 1813:

```
#ufw allow 1812/udp
```

```
Rules updated
```

```
Rules updated (v6)
```

The clients must be configured in `/etc/freeradius/3.0/clients.conf` by adding their IPs with the "shared secret". For example, this can be done as follows:

```
client nashostname {  
  ipaddr = 172.17.5.13  
  secret = ourchosensecret  
}
```

A subnet can be used as IP address too:

```
client mynasnetwork {  
  ipaddr = 172.17.5.0/24  
  secret = sevensecret
```

```
}

```

The configuration of the users can be done in the file `/etc/freeradius/3.0/users` by using the following lines:

```
username Cleartext-Password := "userpassword"
```

```
[other-configs]
```

An example can be:

```
test-radius Cleartext-Password := "password"
```



Note: If your WR-ZEN unit has been used as the client, the password must be configured for the root user. Registration of new users is not allowed in this device so root is the only existing user.

9.8 List of supported SFPs

Information on the supported SFPs is shown in the following table. Although our devices are compatible with other SFPs, the use of any SFP outside this list may cause synchronization errors for which we are not responsible.

Model	Wavelength (nm)	Media	Power (dBm)	Sensitivity (dBm)	Distance
AXGE-1254-0531	T1310/R1490	SMF	-9 ~ -3	-20	10km
AXGE-3454-0531	T1490/R1310	SMF	-9 ~ -3	-20	10km

9.9 List of Tables

Table 1-1: Options and Licenses available in WR-ZEN	3
Table 2-1: Front Panel of the WR-ZEN TP Legend	8
Table 2-2: Front Panel of the WR-ZEN TP 32-BNC Legend	10
Table 2-3: Front Panel of the WR-ZEN TP-FL Legend	13
Table 2-4: Back Panel of the WR-ZEN TP Legend	15
Table 2-5: Status LED behavior	16
Table 2-6: Ports LED behavior	17
Table 2-7: Safety symbols used in this document, or on the product	21
Table 3-1: Default Factory Settings	26

Table 3-2: UART Settings	27
Table 4-1: Configuration parameters of the network interface.	37
Table 4-2: Information related to the network interface	38
Table 5-1: Timing source info description	63
Table 5-2: IEEE 1588 configuration with/without license	69
Table 5-3: PTP information for a port interface	76
Table 5-4: Advanced PTP information for a port instance	77
Table 6-1: Default firewall configuration	98
Table 9-1: Orolia contact information	153

9.10 List of Images

Figure 1-1: Intra-datacenter WR network topology	3
Figure 1-2: WR-ZEN TP-FL (left), WR-ZEN TP (middle), WR-ZEN TP-32BNC (right) 4	
Figure 2-1: WR-ZEN TP front panel	8
Figure 2-2: WR-ZEN TP 32-BNC front panel	10
Figure 2-3: WR-ZEN TP-FL front panel	13
Figure 2-4: WR-ZEN TP rear panel	15
Figure 3-1: Device manager. New serial port detected.	30
Figure 3-2: Putty configuration for serial port connection.	31
Figure 3-3: Dashboard of the web interface.	32
Figure 3-4: Login page of the web interface	32
Figure 3-5: All sections on the web interface	33
Figure 4-1: Dashboard in web interface	39
Figure 4-2: Settings menu in web interface	39
Figure 4-3: Time sources configuration in web interface	40
Figure 4-4: Network interface panel in web GUI	41
Figure 4-5: Configuration of static IP using web interface	41
Figure 4-6: Warning message to reboot the device so a saved change can take effect	41
Figure 4-7: Main wrz_config interface. Modules to modify	43
Figure 4-8: wrz_config interface. Network interfaces to change	44
Figure 4-9: wrz_config interface. Interface parameters to change	44
Figure 4-10: wrz_config interface. File in which to save the new applied configuration	45
Figure 4-11: Example of gpa_ctrl usage to list power supplies parameters.	46
Figure 5-1: Multi-timing sources handle by FOCA policy with its two strategies: only fall-down (blue) & re-evaluation (purple)	51
Figure 5-2: FOCA algorithm under scenario 1	52

Figure 5-3: Data-flow between timing sources, virtual clock and outputs	53
Figure 5-4: Virtual Clock Overview	54
Figure 5-5: Custom Preset for timing sources configuration	58
Figure 5-6: Mixing PTP and WR master ports (wr0 & wr1)	59
Figure 5-7: Custom Preset with CLI tool	60
Figure 5-8: Port configuration (e.g., wr0) from CLI tool	60
Figure 5-9: Reference topology with different presets.	61
Figure 5-10: Info for Timing Source #1	62
Figure 5-11: Advanced info Timing Source #1	63
Figure 5-12: Configuration of WR instance.	64
Figure 5-13: WR Interfaces overview (Only first interface captured (wr0)).	65
Figure 5-14: Advanced WR interface Overview (WR0 configured as slave)	67
Figure 5-15: Unlicensed VS Licensed PTP daemon	70
Figure 5-16: Simplified PTP packets exchange for delay measurement (1) End-to-end (2) Peer-to-peer.	73
Figure 5-17: Selecting ITU-G 8275.1 Telecom profile for wr4 interface	73
Figure 5-18: wr0 port as active PTP slave with its advanced view expanded.	76
Figure 5-19: Overview tab for GM timing source.	80
Figure 5-20: Holdover overview meanwhile learning	86
Figure 5-21: Manual Leap seconds update.	88
Figure 6-1: Security-HTTP/HTTPS menu of Web Interface.	91
Figure 6-2: Using HTTPS with generated certificate.	91
Figure 6-3: Using HTTPS with uploaded certificate.	92
Figure 6-4: TACACS setup for verifying the installation.	93
Figure 6-5: SSH connection with the WR-ZEN board	94
Figure 6-6: tac_plus output with debug information	95
Figure 6-7: Set-up RADIUS for verifying the installation	96
Figure 6-8: SSH connection with the WR-ZEN board	97
Figure 6-9: Freeradius failed attempt with debug information	97
Figure 7-1: Logging configuration parameters through CLI.	105
Figure 7-2: SNMP configuration.	108
Figure 7-3: SNMP traps scheme.	112
Figure 7-4: LLDP configuration from CLI	116
Figure 7-5: Healthing configuration through CLI.	122
Figure 8-1: Checking available licenses.	133
Figure 8-2: Devices Management in License Portal.	135
Figure 8-3: Licenses Configuration Panel	137
Figure 8-4: HW version displayed in dashboard.	139
Figure 8-5: Update Procedure Waiting screen.	140
Figure 8-6: Downgrade warning on the GUI.	140
Figure 8-7: Force flashing incompatible firmware.	140
Figure 8-8: Flashing hardware v5.0 with incompatible firmware.	141

Figure 8-9: Management panel in recovery mode142

9.11 Document Revision History

Rev	Description	Date
V3.0-a	Fully updated documentation of wr-zynq-os-3.0 for WR-Z16 family	24-Jul-2020
V3.1-a	Improve PTP profiles + sync-E configuration, add new VCS code and fix some OID errors	30-Oct-2020
V3.1-b	Fixing missing references in the document	26-Jan-2021
V3.2-a	Improving LLDP and NTP section Adding new section (Timing outputs) for ZEN family	05-Apr-2022
V3.3-a	System reliability improved, security and authentication (including web GUI) update and new features, time of day (ToD) daemon support, bug-fixes	12-Jul-2022
V3.4	Changes to firmware update section, added a new support list. Switch to Orolia branding.	14-Oct-2022

BLANK PAGE.

INDEX

A

API 36

C

CLI 42, 45

Connecting 26

credentials 26

Custom Preset 58

Custom Profile 73

D

Default 26

Dimension 18

E

EMC 24

Environmental 18

External Reference 79

F

Factory Config 144

Factory Config Mode 144

Failsafe 144

Failsafe Mod 144

Fanout 59

FAQ 149

Firewall 98

Firmware Update 138

FOCA 50

Front panel 8

G

General Status 16

GUI 38

H

Healthing 120

Holdover 3, 49-50, 61, 66, 84,
155

HTTP 90

HTTPS 90

I

IEEE 1588-2008 68

Installation 23

L

LCD screen 123
Leap second 68, 80
LED 16
License 69
Licenses 132
LLDP 115

M

Memory 18
Monitoring 45
Multi-sources 50

N

NTP 81

P

password 26
Permanent log 103
Presets 55
Product Specifications 18
PTP 2
PTPv2 68

R

RADIUS 95
Rear panel 15
Recovery Mode 142
Regulatory Compliance 24
Remote logs 103

Resiliency 50
RoHS 24

S

Safety
 instructions
 symbols 21
 Symbols 21
Session logs 102
SFP 17, 164
SNMP 105
Specifications 18
SSH 27, 90
Stratum 83
Syslog 102

T

TACACS+ 93
Technical support 153
Timing Management 54
Timing Sources 50
Troubleshooting 149

U

UART 26
Update 138
Upgrade 138

V

Virtual Clock 53

W

Web GUI 38

White Rabbit 2, 64

WR 2

WR-ZEN TP 18

WR-ZEN TP-32BNC 20

WR-ZEN TP-FL 19

WRZ-OS 3